



Connectors > Automotive Connectors > Automotive Connector Accessories > Automotive Connector Locks & Position Assurance >

DEUTSCH DTM Wedgelocks



Number of Positions: 2

Primary Product Color: **Black**

Connector & Contact Retention Accessory Type: **Secondary Lock**

Primary Product Material: **PBT**

Operating Temperature Range: -55 – 125 °C [-67 – 257 °F]

[All DEUTSCH DTM Wedgelocks \(25\)](#)

Features

Product Type Features

Sealable	No
Connector & Contact Retention Accessory Type	Secondary Lock

Configuration Features

Number of Positions	2
---------------------	---

Body Features

Primary Product Color	Black
Primary Product Material	PBT

Usage Conditions

Operating Temperature Range	-55 – 125 °C [-67 – 257 °F]
-----------------------------	-----------------------------

Industry Standards

UL Flammability Rating	UL 94HB
------------------------	---------

Packaging Features

Packaging Method	Box
Packaging Quantity	25000

Other

Serviceable	Yes
-------------	-----

Product Compliance

[For compliance documentation, visit the product page on TE.com>](#)

EU RoHS Directive 2011/65/EU	Compliant
EU ELV Directive 2000/53/EC	Compliant
China RoHS 2 Directive MIIT Order No 32, 2016	No Restricted Materials Above Threshold
EU REACH Regulation (EC) No. 1907/2006	Current ECHA Candidate List: JAN 2025 (247) Candidate List Declared Against: JAN 2025 (247) Does not contain REACH SVHC
Halogen Content	Low Halogen - Br, Cl, F, I < 900 ppm per homogenous material. Also BFR/CFR/PVC Free
Solder Process Capability	Not reviewed for solder process capability

Product Compliance Disclaimer

This information is provided based on reasonable inquiry of our suppliers and represents our current actual knowledge based on the information they provided. This information is subject to change. The part numbers that TE has identified as EU RoHS compliant have a maximum concentration of 0.1% by weight in homogenous materials for lead, hexavalent chromium, mercury, PBB, PBDE, DBP, BBP, DEHP, DIBP, and 0.01% for cadmium, or qualify for an exemption to these limits as defined in the Annexes of Directive 2011/65/EU (RoHS2). Finished electrical and electronic equipment products will be CE marked as required by Directive 2011/65/EU. Components may not be CE marked. Additionally, the part numbers that TE has identified as EU ELV compliant have a maximum concentration of 0.1% by weight in homogenous materials for lead, hexavalent chromium, and mercury, and 0.01% for cadmium, or qualify for an exemption to these limits as defined in the Annexes of Directive 2000/53/EC (ELV). Regarding the REACH Regulation, the information TE provides on SVHC in articles for this part number is based on the latest European Chemicals Agency (ECHA) 'Guidance on requirements for substances in articles' posted at this URL: <https://echa.europa.eu/guidance-documents/guidance-on-reach>

Compatible Parts



Also in the Series | DEUTSCH DT

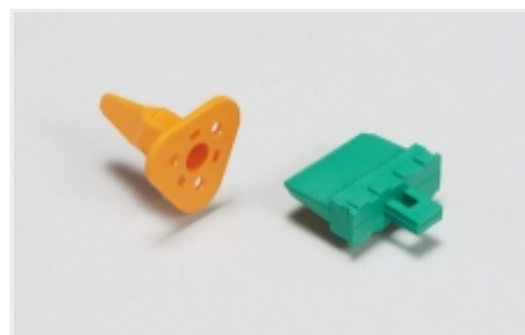

Automotive Connector Locks & Position Assurance(26)



Automotive Housings(109)



Connector Caps & Covers(1)



Connector Seals & Cavity Plugs(1)



Connector Strain Relief(28)



Other Automotive Connector Accessories(7)

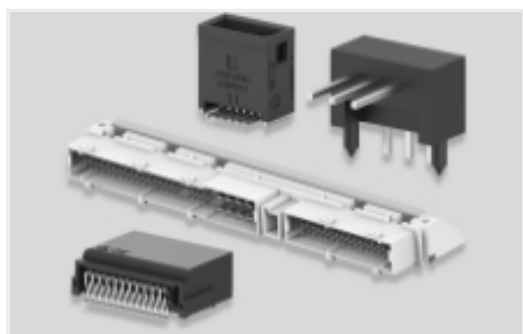

PCB Headers & Receptacles(38)



Rectangular Backshells & Clamps(1)

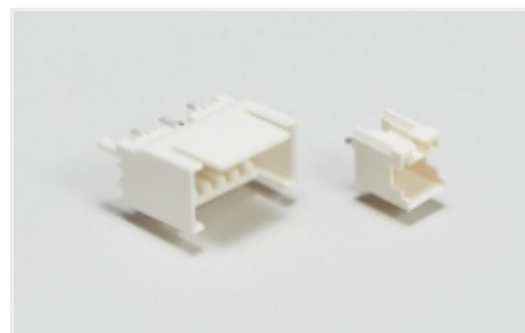

Wire-to-Board Headers & Receptacles (38)

Also in the Series | DEUTSCH DTM



Automotive Connector Caps & Covers (7)

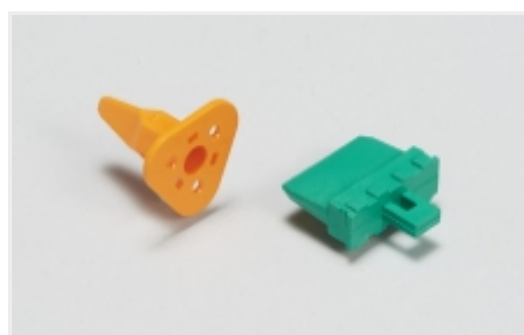

Automotive Connector Locks & Position Assurance(26)



Automotive Housings(109)



Connector Strain Relief(28)

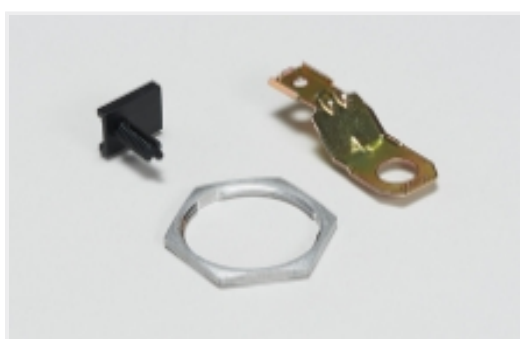

Other Automotive Connector Accessories(7)

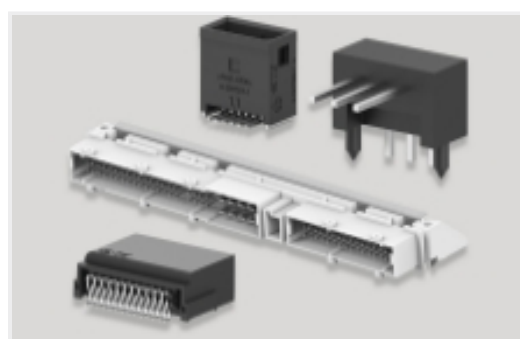

PCB Headers & Receptacles(38)

Customers Also Bought



TE Part #HD36-24-47PE
PLG, 47P, AL, E, 16/20, P



TE Part #2-1630019-1
HSC200 470R 5%



TE Part #CAT-D485-CH8172
DEUTSCH DTM Housings

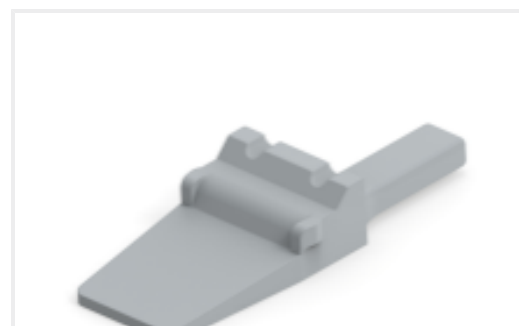

TE Part #WM-2PA
WEDGE LOCK, 2P, REC, GRY, DTM, A



TE Part #2141613-2
CARRIER, SEAL,YW



TE Part #2141630-1
5POS,HVA630,REC HSG ASSY,
180DEG,HVIL



TE Part #2141612-2
RADIAL SEAL 25 X 43, CABLE SEAL,
YW

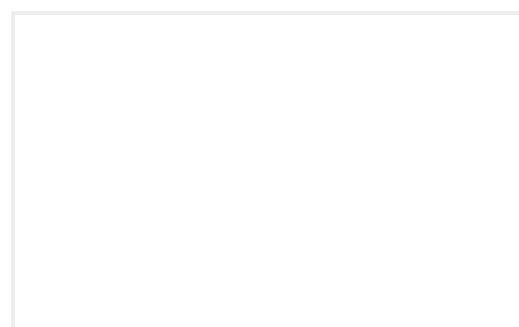

TE Part #6-1355512-7
47 WAY ABS CONNECTOR



TE Part #2141614-2
COVER, CABLE SEAL

Documents

Product Drawings

WEDGE LOCK, 2P, REC, BLK, DTM, B

English

CAD Files

3D PDF

3D

Customer View Model

ENG_CVM_CVM_WM-2PB_A.2d_dxf.zip



English

Customer View Model

[ENG_CVM_CVM_WM-2PB_A.3d_igs.zip](#)

English

Customer View Model

[ENG_CVM_CVM_WM-2PB_A.3d_stp.zip](#)

English

By downloading the CAD file I accept and agree to the [Terms and Conditions](#) of use.

Datasheets & Catalog Pages

[TERMINALS AND CONNECTORS](#)

English

[ICT Terminals and Connectors Catalogue](#)

English

[CONNECTOR SELECTOR](#)

English

Product Specifications

[Application Specification](#)

English

Agency Approvals

[UL Report](#)

English