

DTP4P-L012-GKT ✓ ACTIVE

DEUTSCH | DEUTSCH DT, DEUTSCH DTP

TE Internal #: DTP4P-L012-GKT

Gasket, -57 – 107 °C [-71 – 225 °F], Black, Closed Cell Sponge, DEUTSCH DTP

[View on TE.com >](#)



Connectors > Connector Accessories > Connector Seals & Cavity Plugs



Connector Seal & Plug Type: **Gasket**

Operating Temperature Range: -57 – 107 °C [-71 – 225 °F]

Primary Product Color: **Black**

Primary Product Material: **Closed Cell Sponge**

Operating Temperature (Max): 107 °C [225 °F]

Features

Product Type Features

Connector Seal & Plug Type	Gasket
----------------------------	--------

Body Features

Primary Product Color	Black
Primary Product Material	Closed Cell Sponge

Usage Conditions

Operating Temperature Range	-57 – 107 °C[-71 – 225 °F]
Operating Temperature (Max)	107 °C[225 °F]

Industry Standards

UL Flammability Rating	UL 94HBF
------------------------	----------

Packaging Features

Packaging Method	Box
------------------	-----

Other

Contains Lubricant	No
--------------------	----



Product Compliance

[For compliance documentation, visit the product page on TE.com>](#)

EU RoHS Directive 2011/65/EU	Compliant
EU ELV Directive 2000/53/EC	Out of Scope
China RoHS 2 Directive MIIT Order No 32, 2016	No Restricted Materials Above Threshold
EU REACH Regulation (EC) No. 1907/2006	Current ECHA Candidate List: JAN 2025 (247) Candidate List Declared Against: JAN 2025 (247) Does not contain REACH SVHC
Halogen Content	Not Low Halogen - contains Br or Cl > 900 ppm.
Solder Process Capability	Not reviewed for solder process capability

Product Compliance Disclaimer

This information is provided based on reasonable inquiry of our suppliers and represents our current actual knowledge based on the information they provided. This information is subject to change. The part numbers that TE has identified as EU RoHS compliant have a maximum concentration of 0.1% by weight in homogenous materials for lead, hexavalent chromium, mercury, PBB, PBDE, DBP, BBP, DEHP, DIBP, and 0.01% for cadmium, or qualify for an exemption to these limits as defined in the Annexes of Directive 2011/65/EU (RoHS2). Finished electrical and electronic equipment products will be CE marked as required by Directive 2011/65/EU. Components may not be CE marked. Additionally, the part numbers that TE has identified as EU ELV compliant have a maximum concentration of 0.1% by weight in homogenous materials for lead, hexavalent chromium, and mercury, and 0.01% for cadmium, or qualify for an exemption to these limits as defined in the Annexes of Directive 2000/53/EC (ELV). Regarding the REACH Regulation, the information TE provides on SVHC in articles for this part number is based on the latest European Chemicals Agency (ECHA) 'Guidance on requirements for substances in articles' posted at this URL: <https://echa.europa.eu/guidance-documents/guidance-on-reach>

Compatible Parts



Also in the Series | **DEUTSCH DT**

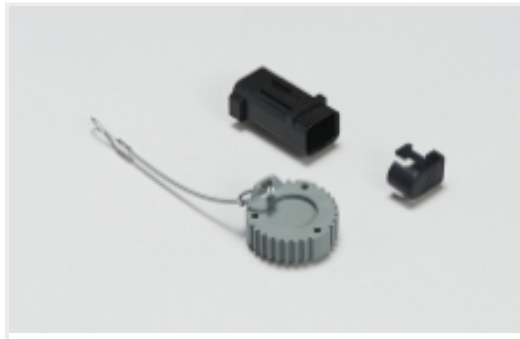

Automotive Connector Caps & Covers (19)



Connector Caps & Covers(1)

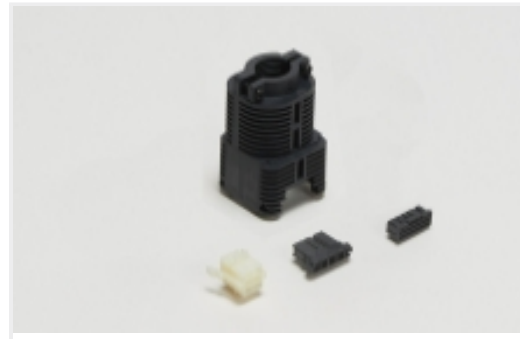

Rectangular Connector Housings(1)



Rectangular Power Connectors(5)



Standard Rectangular Connectors(1)

Also in the Series | DEUTSCH DTP

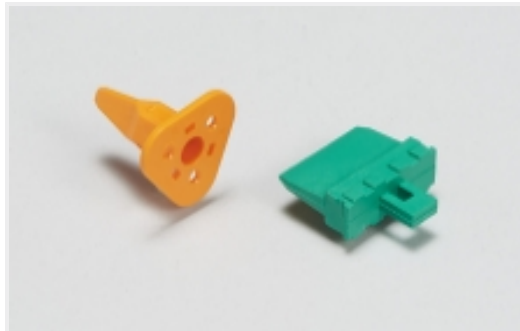

Automotive Connector Locks & Position Assurance(4)



Automotive Headers(5)

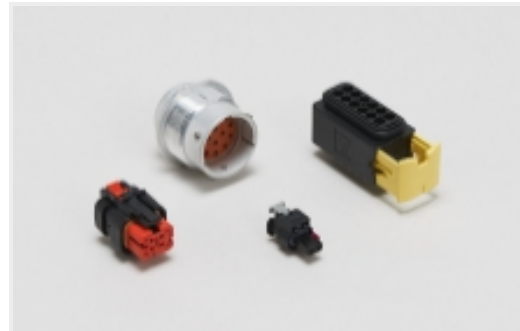

Automotive Housings(34)



Connector Seals & Cavity Plugs(2)



Insertion & Extraction Tools(3)



Other Automotive Connector Accessories(4)

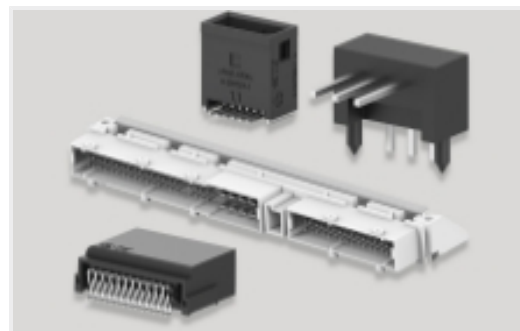

PCB Headers & Receptacles(5)



Rectangular Backshells & Clamps(3)

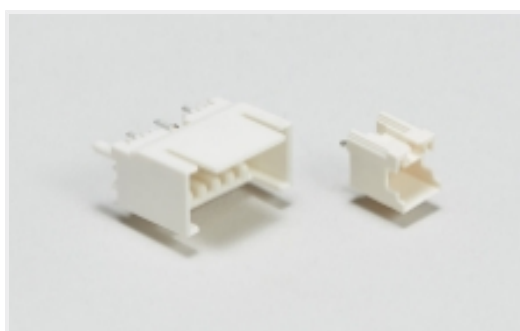

Wire-to-Board Headers & Receptacles (5)

Customers Also Bought

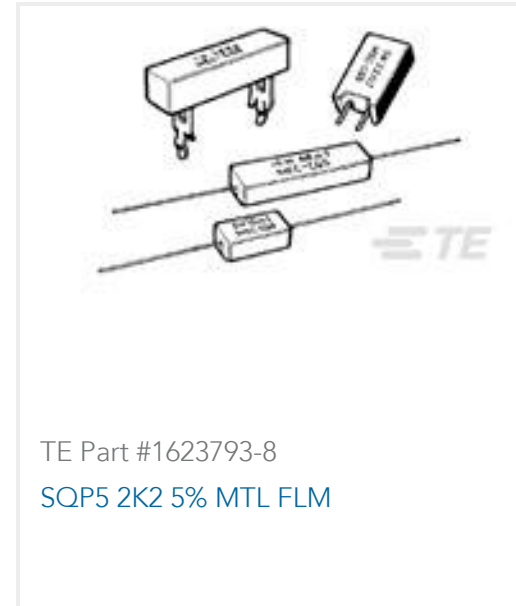

Documents

Product Drawings

[GASKET, 4P, BLK, DTP](#)

English

CAD Files

[3D PDF](#)

3D

Customer View Model

[ENG_CVM_CVM_DTP4P-L012-GKT_A.2d_dxf.zip](#)

English

Customer View Model

[ENG_CVM_CVM_DTP4P-L012-GKT_A.3d_igs.zip](#)

English

Customer View Model

[ENG_CVM_CVM_DTP4P-L012-GKT_A.3d_stp.zip](#)

English

By downloading the CAD file I accept and agree to the [Terms and Conditions](#) of use.

Datasheets & Catalog Pages

[TERMINALS AND CONNECTORS](#)

English

[CONNECTOR SELECTOR](#)

English

Product Specifications

[Application Specification](#)



English