

# DTM06-12SA ✓ ACTIVE

DEUTSCH | DEUTSCH DT, DEUTSCH DTM

TE Internal #: DTM06-12SA

12 Position Housing, Housing for Female Terminals, Wire-to-Wire, 3.81 mm [.15 in] Centerline, Sealable, Gray, Wire & Cable, Power, Hybrid

[View on TE.com >](#)



Connectors > Automotive Connectors > Automotive Housings > DEUTSCH DTM Housings

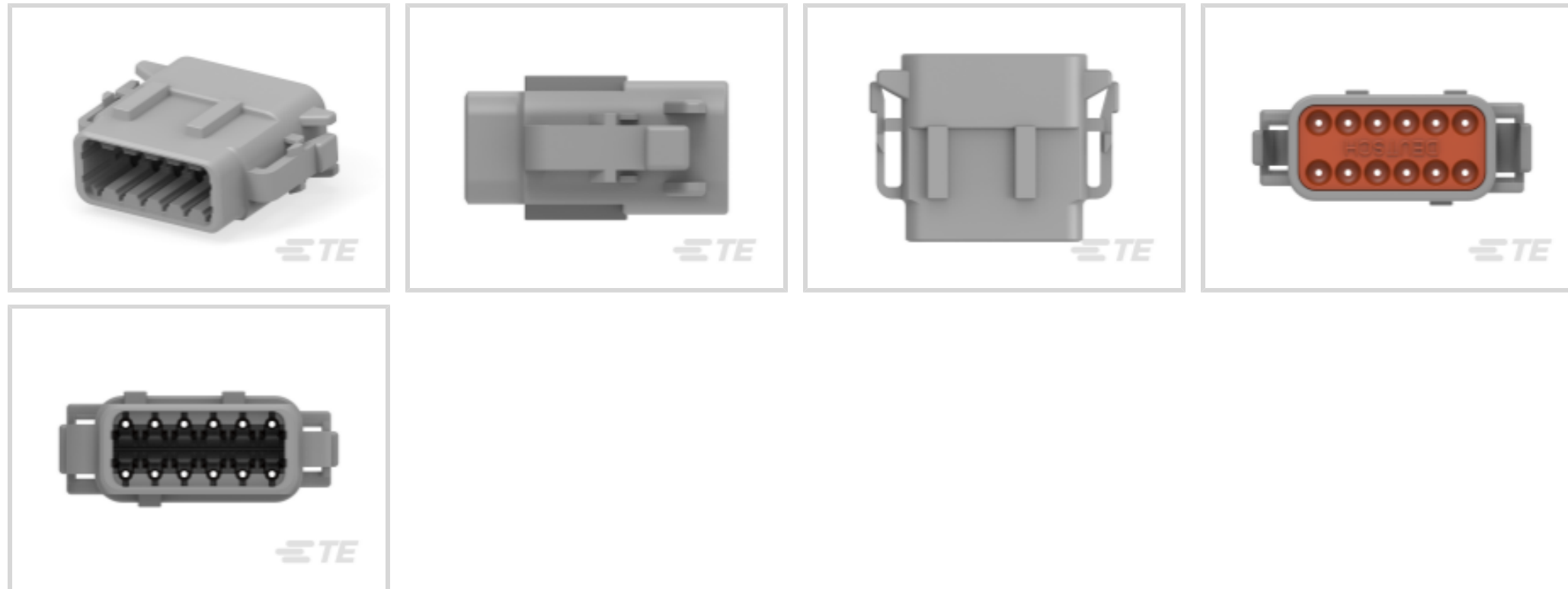

Number of Positions: 12

Connector & Housing Type: **Housing for Female Terminals**

Mating Pin Diameter: 1.02 mm [.04 in]

Connector System: **Wire-to-Wire**

Centerline (Pitch): 3.81 mm [.15 in]

[All DEUTSCH DTM Housings \(113\)](#)

## Features

### Product Type Features

Mixed & Hybrid Connector	No
Connector Shape	Rectangular
Connector & Housing Type	Housing for Female Terminals
Connector System	Wire-to-Wire
Sealable	Yes
Primary Locking Feature	Integrated in Housing
Connector & Contact Terminates To	Wire & Cable

### Configuration Features

Blank Cavity Position	0
Number of Positions	12
Number of Rows	2

### Electrical Characteristics



Operating Voltage	250 VDC
Nominal Voltage Architecture	12 V, 24 V, 48 V

### Body Features

Cable Exit Angle	180°
Primary Product Color	Gray
Connector & Keying Code	A

### Contact Features

Contact Size	Size 20
Contact Type	Socket
Mating Pin Diameter	1.02 mm[.04 in]
Contact Current Rating (Max)	7.5 A

### Mechanical Attachment

Strain Relief	Without
Terminal Position Assurance	Yes
Mating Alignment Type	Keyed
Mating Alignment	With
Connector Mounting Type	Cable Mount (Free-Hanging)

### Housing Features

Housing Material	PA 66 GF15
Centerline (Pitch)	3.81 mm[.15 in]

### Dimensions

Row-to-Row Spacing	7.11 mm[.28 in]
Compatible Insulation Diameter Range	1.35 – 3.05 mm[.053 – .12 in]
Product Width	15.2 mm[.6 in]
Product Length	37.8 mm[1.49 in]
Connector Height	29.9 mm[1.18 in]

### Usage Conditions

Operating Temperature (Max)	125 °C[257 °F]
Operating Temperature Range	-55 – 125 °C[-67 – 257 °F]

### Operation/Application

Circuit Application	Power
---------------------	-------

### Industry Standards



IP Rating	IP68, IP6K9K
Compatible With Agency/Standards Products	SAE J2030
UL Flammability Rating	UL 94V-0

### Packaging Features

Packaging Quantity	1
Packaging Method	Package

### Other

Serviceable	Yes
Connector Position Assurance Capable	No

### Product Compliance

[For compliance documentation, visit the product page on TE.com>](#)

EU RoHS Directive 2011/65/EU	Compliant
EU ELV Directive 2000/53/EC	Compliant
China RoHS 2 Directive MIIT Order No 32, 2016	No Restricted Materials Above Threshold
EU REACH Regulation (EC) No. 1907/2006	Current ECHA Candidate List: JAN 2025 (247) Candidate List Declared Against: JUNE 2024 (241) SVHC > Threshold: Octamethylcyclotetrasiloxane (D4) (.5% in Component Part) Dodecamethylcyclohexasiloxane (D6) (.5% in Component Part) Decamethylcyclopentasiloxane (D5) (.5% in Component Part) <b>Article Safe Usage Statements:</b> Wash thoroughly after handling. Recycle if possible and dispose of the article by following all applicable governmental regulations relevant to your geographic location.
Halogen Content	Not Low Halogen - contains Br or Cl > 900 ppm.
Solder Process Capability	Not reviewed for solder process capability

#### Product Compliance Disclaimer

This information is provided based on reasonable inquiry of our suppliers and represents our current actual knowledge based on the information they provided. This information is subject to change. The part numbers that TE has identified as EU RoHS compliant have a maximum concentration of 0.1% by weight in homogenous materials for lead, hexavalent chromium, mercury, PBB, PBDE, DBP, BBP, DEHP, DIBP, and 0.01% for cadmium, or qualify for an exemption to these limits as defined in the Annexes of Directive 2011/65/EU (RoHS2). Finished electrical and electronic equipment products will be CE marked as required by Directive 2011/65/EU. Components may not be CE marked. Additionally, the part numbers that TE has identified as EU ELV compliant have a maximum concentration of 0.1% by weight in homogenous materials for lead, hexavalent chromium, and mercury, and 0.01% for cadmium, or qualify for an exemption to these limits as defined in the Annexes of Directive 2000/53/EC (ELV). Regarding the REACH Regulation, the information TE provides

on SVHC in articles for this part number is based on the latest European Chemicals Agency (ECHA) 'Guidance on requirements for substances in articles' posted at this URL: <https://echa.europa.eu/guidance-documents/guidance-on-reach>

## Compatible Parts

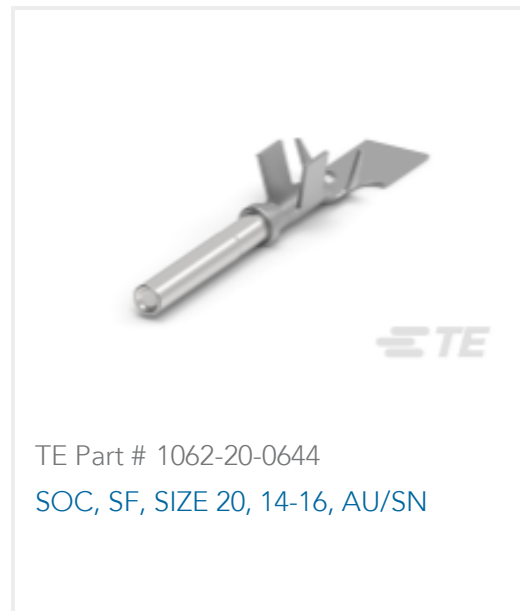
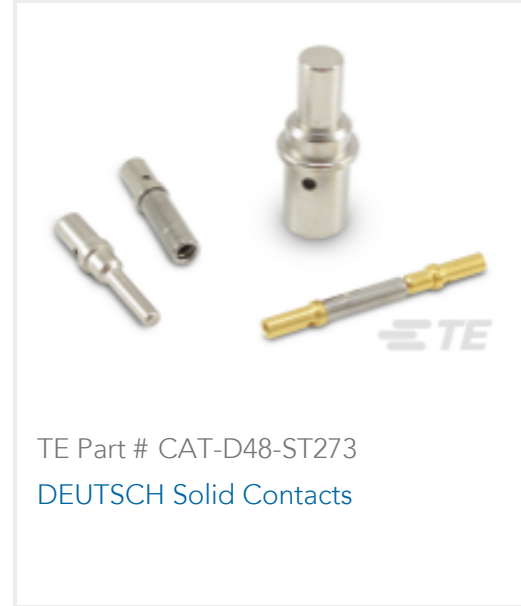



TE Part # 1062-20-0177  
SOC, SF, SIZE 20, 16-22, SN/SN



TE Part # 1062-20-0322  
SOC, SF, SIZE 20, 16-22, SLEVELESS, NI /NI



TE Part # CAT-D48-SP729  
DEUTSCH Sealing Plugs



TE Part # DTM04-12PA-EE04  
REC, 12P, BLK, N, HIGH TEMP, A

### Also in the Series | DEUTSCH DT

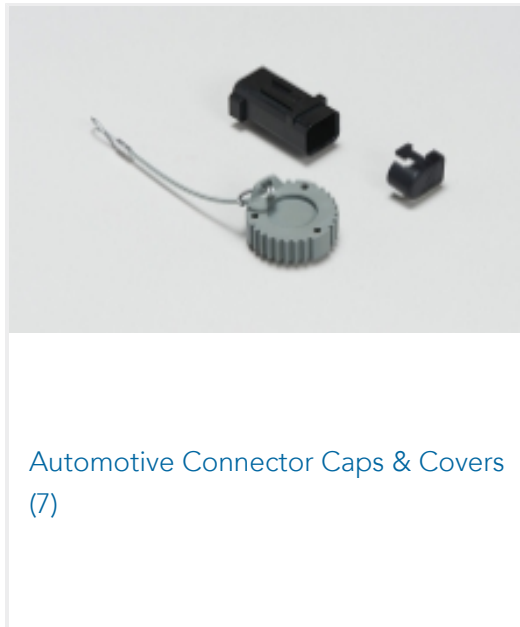

Automotive Connector Caps & Covers (7)

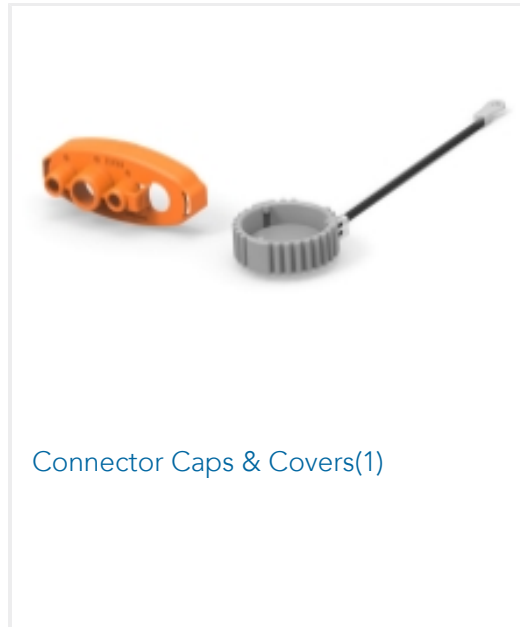

Connector Caps & Covers(1)

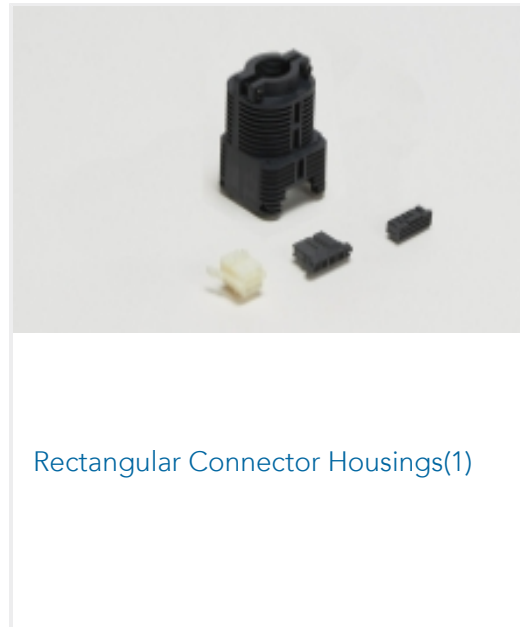

Rectangular Connector Housings(1)



Rectangular Power Connectors(77)

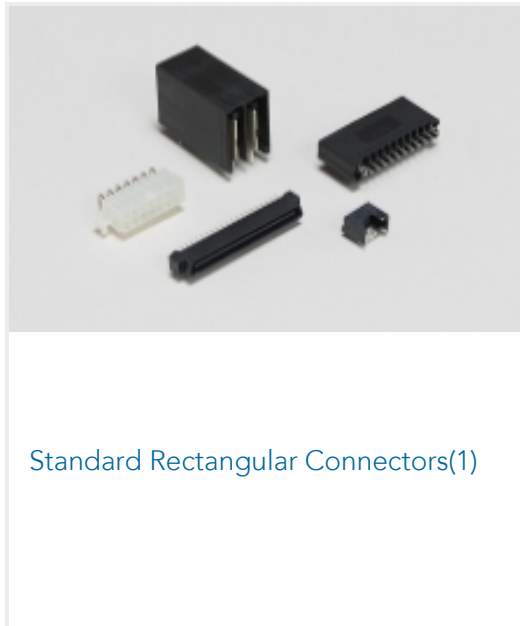

Standard Rectangular Connectors(1)

### Also in the Series | DEUTSCH DTM

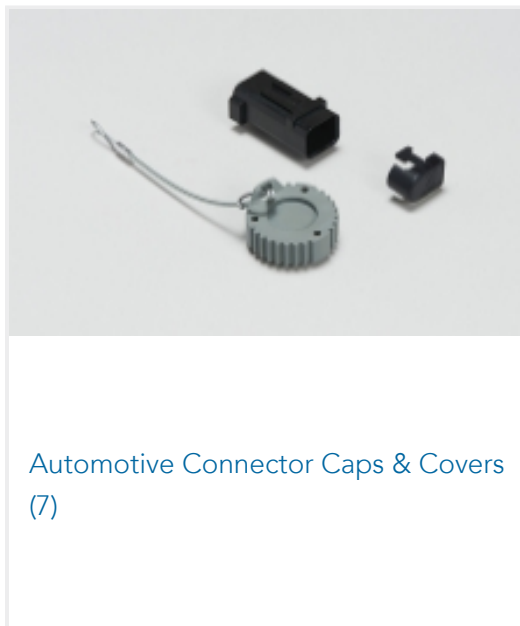

Automotive Connector Caps & Covers (7)



Automotive Connector Locks & Position Assurance(26)

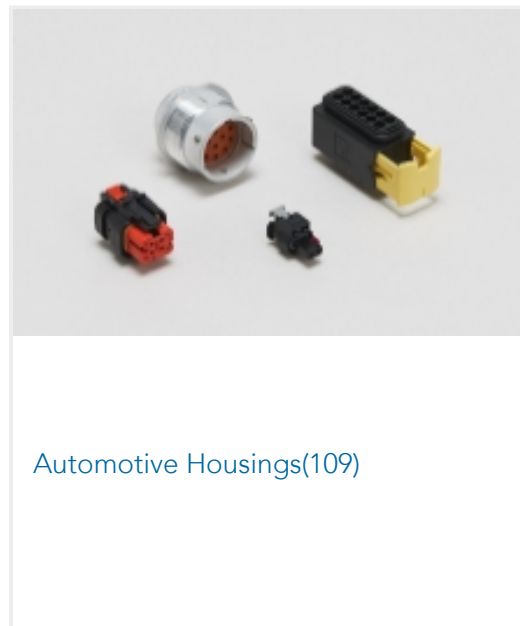

Automotive Housings(109)



Connector Strain Relief(28)

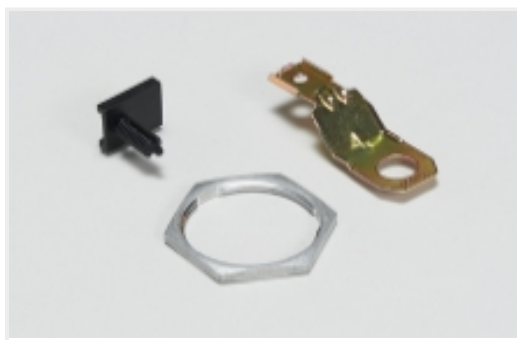

Other Automotive Connector  
Accessories(7)

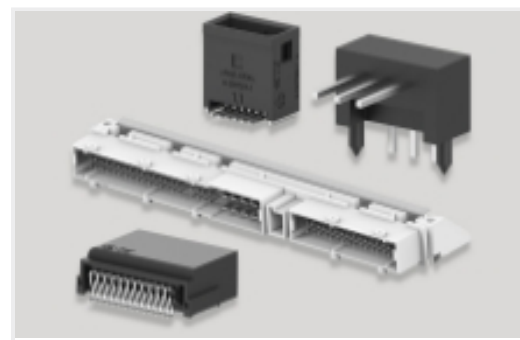

PCB Headers & Receptacles(38)

## Customers Also Bought



TE Part #0462-005-20141  
SOC, SOLID, SIZE 20, 16-18AWG, NI



TE Part #CAT-D485-CH8172  
DEUTSCH DTM Housings



TE Part #CAT-J41-DDPC  
DEUTSCH DT Plug Connectors



TE Part #W12S  
WEDGE LOCK, 12P, PLG, ORG, STD,  
DT



TE Part #WM-2S  
WEDGE LOCK, 2P, PLG, ORG, DTM

## Documents

### Product Drawings

PLG, 12P, GRY, N, A

English

### CAD Files

Customer View Model

[ENG\\_CVM\\_CVM\\_DTM06-12SA\\_99.2d\\_dxf.zip](#)

English

3D PDF

3D

Customer View Model

[ENG\\_CVM\\_CVM\\_DTM06-12SA\\_99.3d\\_igs.zip](#)

English

Customer View Model

[ENG\\_CVM\\_CVM\\_DTM06-12SA\\_99.3d\\_stp.zip](#)

English

By downloading the CAD file I accept and agree to the [Terms and Conditions](#) of use.



---

**Datasheets & Catalog Pages**

[ICT Terminals and Connectors Catalogue](#)

English

**CONNECTOR SELECTOR**

English

---

**Product Specifications**

[Engineering Report](#)

English

---

**Agency Approvals**

[UL Report](#)

English