

81665-1 ✓ ACTIVE

AMP | AMP Circular Plastic Connectors

TE Internal #: 81665-1

Flange Seal, -55 – 105 °C [-67 – 221 °F], Black, AMP Circular Plastic Connectors

[View on TE.com >](#)



Connectors > Connector Accessories > Connector Seals & Cavity Plugs

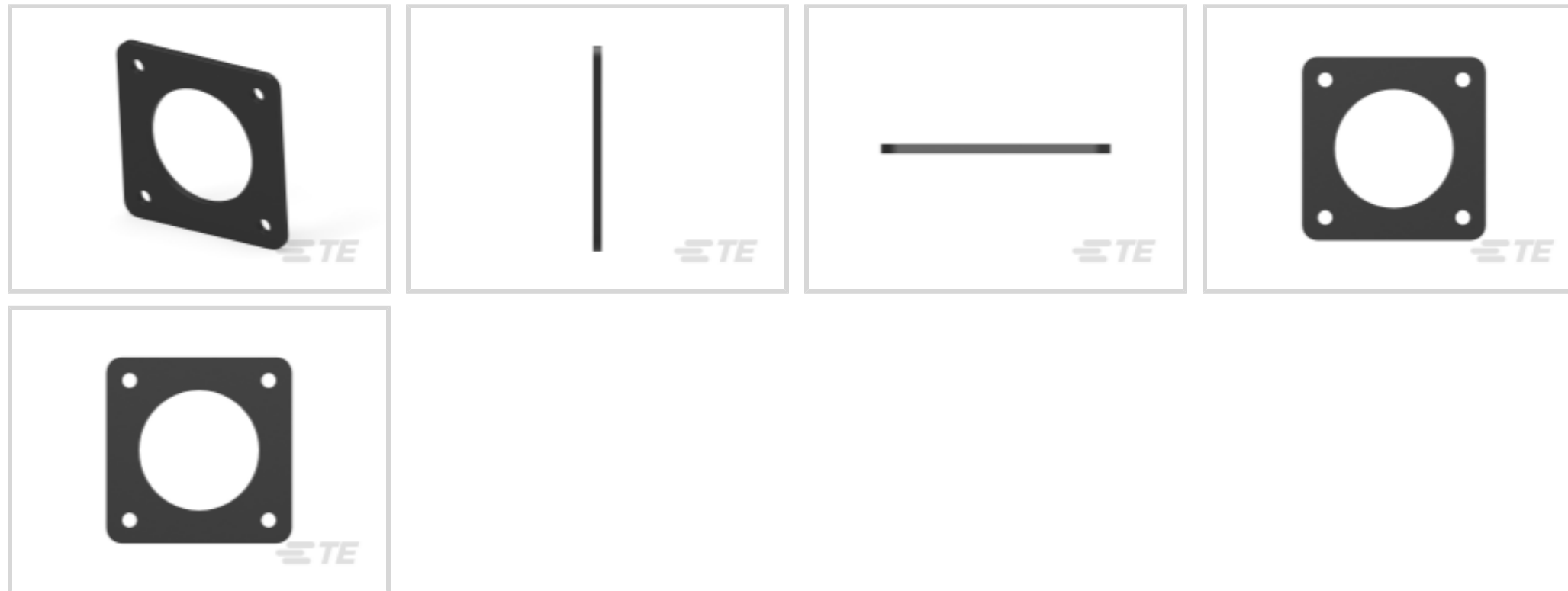

Connector Seal & Plug Type: **Flange Seal**

Operating Temperature Range: -55 – 105 °C [-67 – 221 °F]

Primary Product Color: **Black**

Operating Temperature (Max): 105 °C [221 °F]

## Features

### Product Type Features

Connector Seal & Plug Type	Flange Seal
----------------------------	-------------

### Body Features

Primary Product Color	Black
-----------------------	-------

### Usage Conditions

Operating Temperature Range	-55 – 105 °C[-67 – 221 °F]
Operating Temperature (Max)	105 °C[221 °F]

### Packaging Features

Packaging Method	Individual
Packaging Quantity	1

## Product Compliance

[For compliance documentation, visit the product page on TE.com>](#)

EU RoHS Directive 2011/65/EU	Compliant
EU ELV Directive 2000/53/EC	Compliant
China RoHS 2 Directive MIIT Order No 32, 2016	No Restricted Materials Above Threshold

EU REACH Regulation (EC) No. 1907/2006

Current ECHA Candidate List: JAN 2025  
(247)

Candidate List Declared Against: JAN 2022  
(223)

Does not contain REACH SVHC

Halogen Content

Not Yet Reviewed for halogen content

Solder Process Capability

Not applicable for solder process capability

Product Compliance Disclaimer

This information is provided based on reasonable inquiry of our suppliers and represents our current actual knowledge based on the information they provided. This information is subject to change. The part numbers that TE has identified as EU RoHS compliant have a maximum concentration of 0.1% by weight in homogenous materials for lead, hexavalent chromium, mercury, PBB, PBDE, DBP, BBP, DEHP, DIBP, and 0.01% for cadmium, or qualify for an exemption to these limits as defined in the Annexes of Directive 2011/65/EU (RoHS2). Finished electrical and electronic equipment products will be CE marked as required by Directive 2011/65/EU. Components may not be CE marked. Additionally, the part numbers that TE has identified as EU ELV compliant have a maximum concentration of 0.1% by weight in homogenous materials for lead, hexavalent chromium, and mercury, and 0.01% for cadmium, or qualify for an exemption to these limits as defined in the Annexes of Directive 2000/53/EC (ELV). Regarding the REACH Regulation, the information TE provides on SVHC in articles for this part number is based on the latest European Chemicals Agency (ECHA) 'Guidance on requirements for substances in articles' posted at this URL: <https://echa.europa.eu/guidance-documents/guidance-on-reach>

## Compatible Parts



## Also in the Series | AMP Circular Plastic Connectors

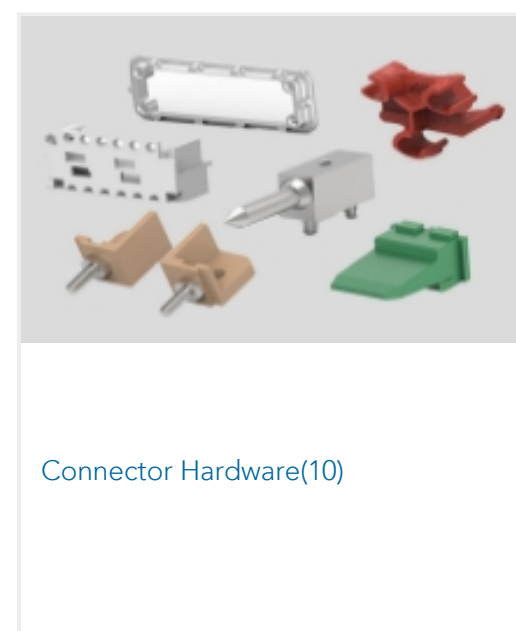
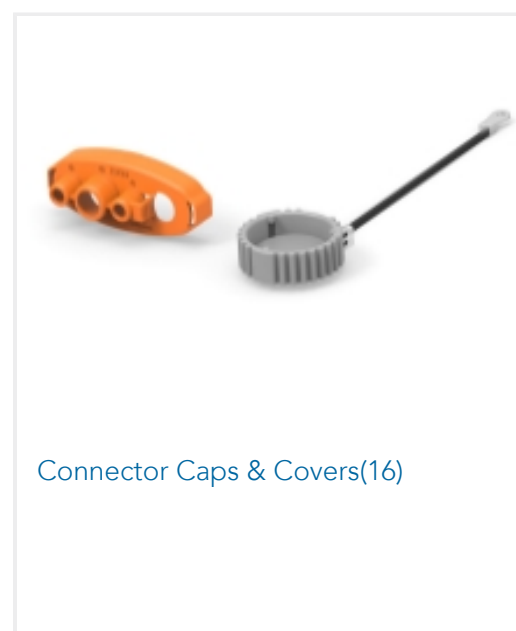
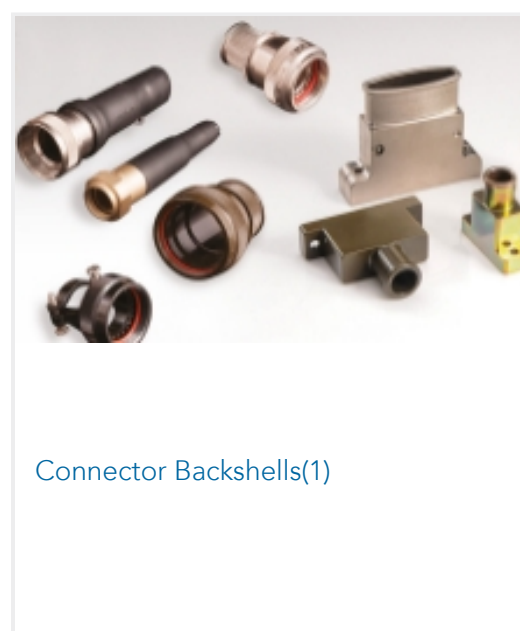
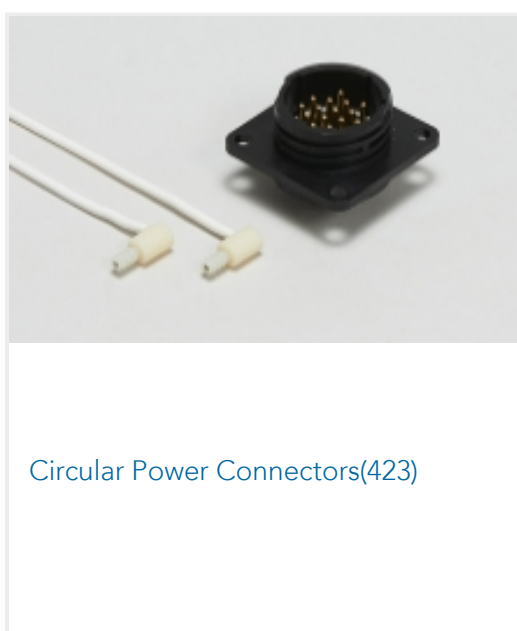

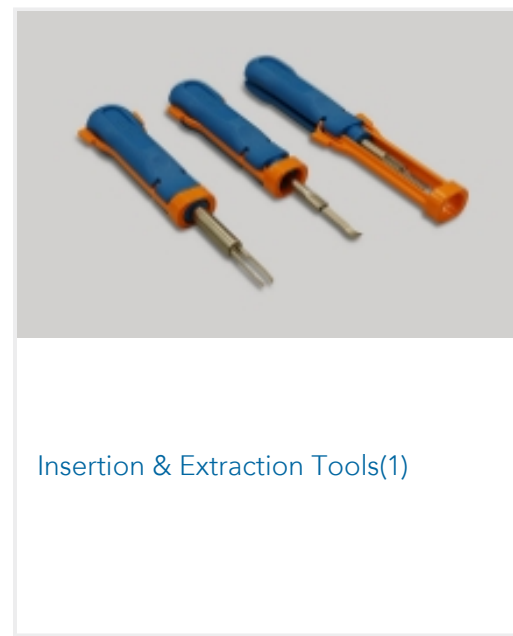
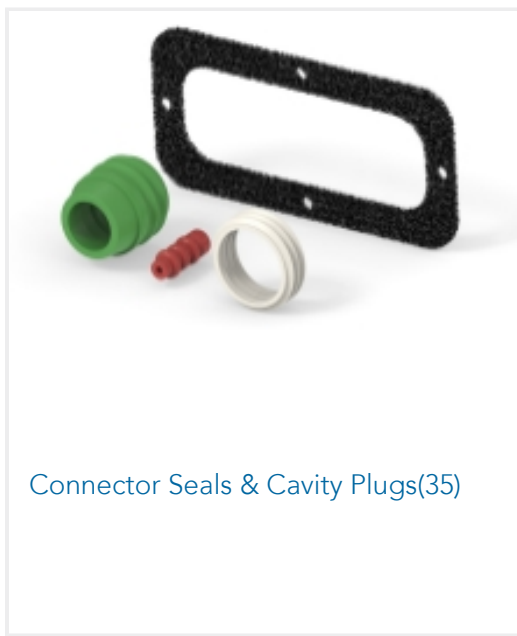

## Customers Also Bought

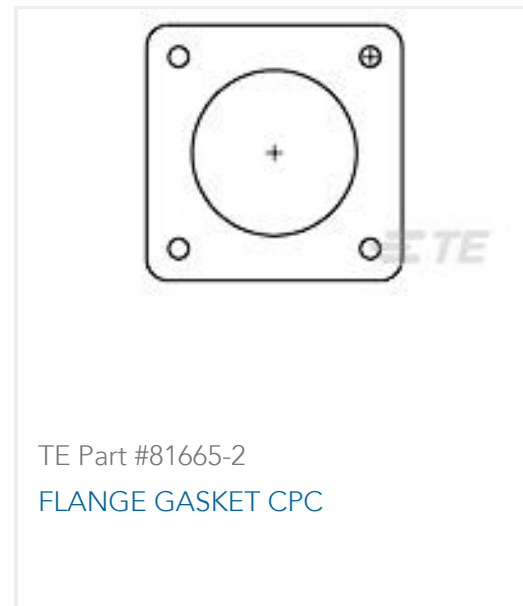

## Documents

### Product Drawings

ECONOSEAL FLANGE, GASKET

English

### CAD Files

3D PDF

English

Customer View Model

[ENG\\_CVM\\_81665-1\\_C.2d\\_dxf.zip](#)

English

Customer View Model

[ENG\\_CVM\\_81665-1\\_C.3d\\_igs.zip](#)

English

Customer View Model

[ENG\\_CVM\\_81665-1\\_C.3d\\_stp.zip](#)

English

3D PDF



3D

Customer View Model

[ENG\\_CVM\\_CVM\\_81665-1\\_E.2d\\_dxf.zip](#)

English

Customer View Model

[ENG\\_CVM\\_CVM\\_81665-1\\_E.3d\\_igs.zip](#)

English

Customer View Model

[ENG\\_CVM\\_CVM\\_81665-1\\_E.3d\\_stp.zip](#)

English

By downloading the CAD file I accept and agree to the [Terms and Conditions](#) of use.

**Product Specifications**

[Application Specification](#)

English