

66597-1 ✓ ACTIVE



AMP | AMP Type III+, Circular Plastic Connectors Series 1

TE Internal #: 66597-1

Pin Contact, Tin (Sn), Size 16 Contact Size, 18 – 14 AWG, .8 – 2 mm²

Wire, Crimp, Brass, Power & Signal, -55 – 150 °C [-67 – 302 °F], AMP

Type III+

[View on TE.com >](#)

Connectors > Contacts > Connector Contacts



Contact Type: **Pin**

Contact Mating Area Plating Material: **Tin (Sn)**

Wire Contact Termination Area Plating Material: **Tin-Lead**

Contact Retention Within Housing: **With**

Contact Size: **Size 16**

Features

Contact Features

Contact Underplating Material	Nickel
Contact Orientation	Straight
Mating Pin Diameter	1.57 mm[.062 in]
Contact Underplating Material Thickness	1.27 µm[50 µin]
Contact Mating Area Plating Material Thickness	2.54 µm[100 µin]
Wire Contact Termination Area Plating Material Finish	Bright
Wire Contact Termination Area Plating Thickness	2.54 µm[100 µin]
Contact Type	Pin
Contact Mating Area Plating Material	Tin (Sn)
Wire Contact Termination Area Plating Material	Tin-Lead
Contact Retention Within Housing	With
Contact Size	Size 16
Contact Base Material	Brass
Contact Current Rating (Max)	13 A



Termination Features

Termination Method to Wire & Cable	Crimp
Product Terminates To	Wire & Cable

Mechanical Attachment

Wire Insulation Support	With
-------------------------	------

Dimensions

Compatible Insulation Diameter Range	2.79 – 3.81 mm [.11 – .15 in]
Wire Size	.8 – 2 mm ²

Usage Conditions

Operating Temperature Range	-55 – 150 °C [-67 – 302 °F]
-----------------------------	-----------------------------

Operation/Application

Circuit Application	Power & Signal
---------------------	----------------

Packaging Features

Packaging Quantity	4000
Packaging Method	Reel

Product Compliance

[For compliance documentation, visit the product page on TE.com>](#)

EU RoHS Directive 2011/65/EU	Not Compliant
EU ELV Directive 2000/53/EC	Compliant with Exemptions
China RoHS 2 Directive MIIT Order No 32, 2016	Restricted Materials Above Threshold
EU REACH Regulation (EC) No. 1907/2006	Current ECHA Candidate List: JAN 2025 (247) Candidate List Declared Against: JAN 2025 (247) SVHC > Threshold: Pb (13% in 4690948374) Article Safe Usage Statements: Do not eat, drink or smoke when using this product. Wash thoroughly after handling. Recycle if possible and dispose of the article by following all applicable governmental regulations relevant to your geographic location.
Halogen Content	Low Halogen - Br, Cl, F, I < 900 ppm per homogenous material. Also BFR/CFR/PVC Free
Solder Process Capability	Not applicable for solder process capability

Product Compliance Disclaimer

This information is provided based on reasonable inquiry of our suppliers and represents our current actual knowledge based on the information they provided. This information is subject to change. The part numbers that TE has identified as EU RoHS compliant have a maximum concentration of 0.1% by weight in homogenous materials for lead, hexavalent chromium, mercury, PBB, PBDE, DBP, BBP, DEHP, DIBP, and 0.01% for cadmium, or qualify for an exemption to these limits as defined in the Annexes of Directive 2011/65/EU (RoHS2). Finished electrical and electronic equipment products will be CE marked as required by Directive 2011/65/EU. Components may not be CE marked. Additionally, the part numbers that TE has identified as EU ELV compliant have a maximum concentration of 0.1% by weight in homogenous materials for lead, hexavalent chromium, and mercury, and 0.01% for cadmium, or qualify for an exemption to these limits as defined in the Annexes of Directive 2000/53/EC (ELV). Regarding the REACH Regulation, the information TE provides on SVHC in articles for this part number is based on the latest European Chemicals Agency (ECHA) 'Guidance on requirements for substances in articles' posted at this URL: <https://echa.europa.eu/guidance-documents/guidance-on-reach>

Compatible Parts



Also in the Series | AMP Type III+

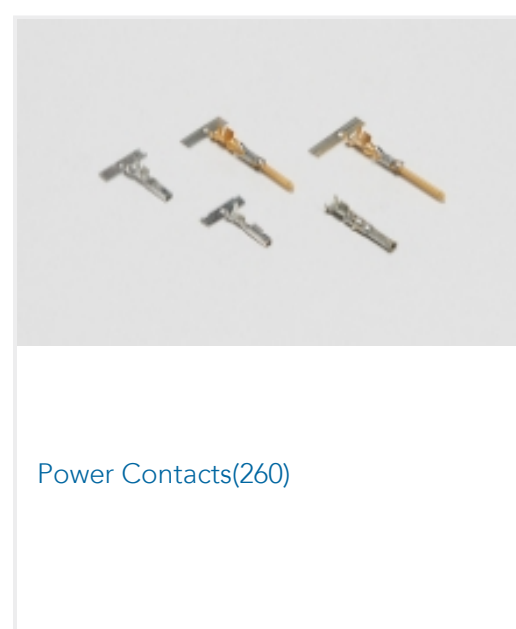
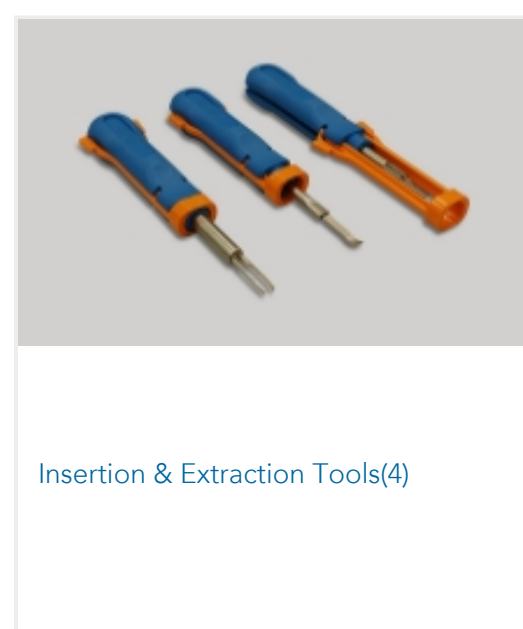
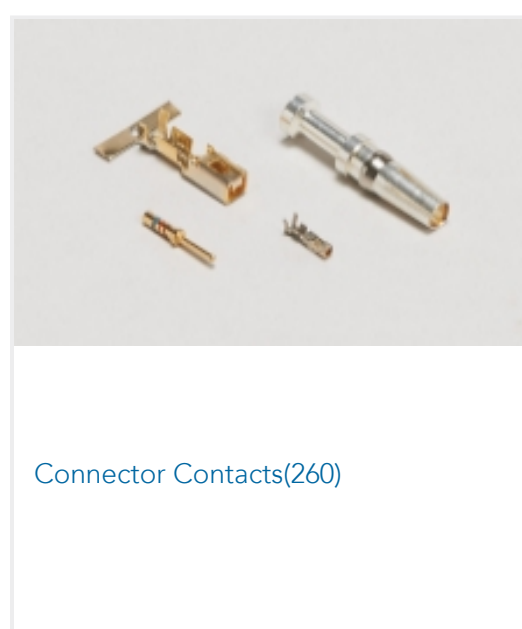

Also in the Series | Circular Plastic Connectors Series 1

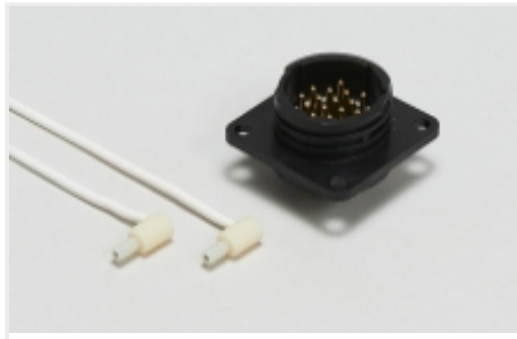

Circular Power Connectors(211)



Connector Contacts(260)



Power Contacts(260)

Customers Also Bought

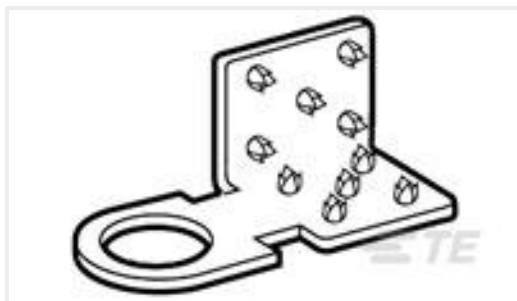
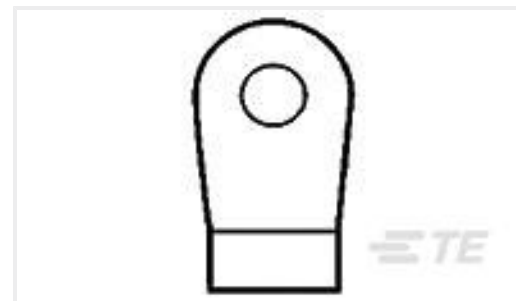
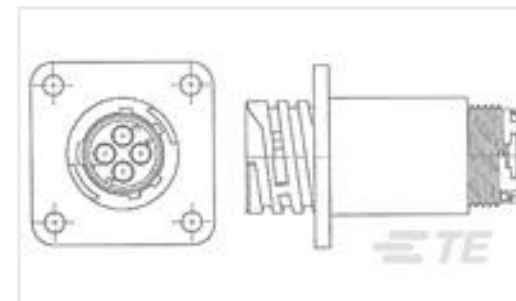
TE Part #1-480318-0
02P CMNL PLUG HSG F/H NATLTE Part #5172625-3
DRAWER CONN. FEMALE ASSY 24PTE Part #2-32947-1
PG R 22-16 COMM 22-18 MIL 6TE Part #207052-1
SZ23 UNASSM KIT,CPCTE Part #276959-2
SPLICE,TERMI-FOIL TAPTE Part #770581-1
12P MINI UMNL PLUG HSGTE Part #321253
TERMINAL,SOLIS FLAG R 2 3/8TE Part #788154-2
SLD CPC RCPT ASSY,11-4,REV SEXTE Part #794276-1
06P UMNL WIRE SEALTE Part #794275-1
06P UMNL INTERFACE SEAL

Documents

Product Drawings

III+ PIN,18-14,TIN-LEAD,STRIP

English

CAD Files

Customer View Model

ENG_CVM_CVM_66597-1_AA.2d_dxf.zip

English

3D PDF



3D

Customer View Model

[ENG_CVM_CVM_66597-1_AA.3d_igs.zip](#)

English

Customer View Model

[ENG_CVM_CVM_66597-1_AA.3d_stp.zip](#)

English

By downloading the CAD file I accept and agree to the [Terms and Conditions](#) of use.

Product Specifications

[Application Specification](#)

English

Instruction Sheets

[Instruction Sheet \(U.S.\)](#)

Japanese

[Instruction Sheet \(U.S.\)](#)

English

Agency Approvals

[Agency Approval Document](#)

English