

66358-9 ✓ ACTIVE



AMP | Circular Plastic Connectors Series 1, AMP Type III+

TE Internal #: 66358-9

Socket Contact, Gold (Au), Locking Spring Contact Retention, Size 16 Contact Size, Discrete Wire, 18 – 14 AWG, .8 – 2 mm<sup>2</sup> Wire, Crimp, AMP Type III+

[View on TE.com >](#)

Connectors > Contacts > Connector Contacts



Contact Type: **Socket**

Contact Mating Area Plating Material: **Gold (Au)**

Wire Contact Termination Area Plating Material: **Tin**

Contact Retention Within Housing: **With**

Contact Retention Type Within Housing: **Locking Spring**

## Features

### Product Type Features

Discrete Wire Type	Solid or Stranded
Sealable	No

### Configuration Features

Compatible With Wire & Cable Type	Discrete Wire
-----------------------------------	---------------

### Contact Features

Contact Underplating Material	Nickel
Contact Orientation	Straight
Mating Pin Diameter	1.57 mm[.062 in]
Contact Underplating Material Thickness	.76 µm[30 µin]
Contact Mating Area Plating Material Thickness	.38 µm[15 µin]
Wire Contact Termination Area Plating Material Finish	Matte
Wire Contact Termination Area Plating Thickness	1.27 µm[50 µin]
Barrel Type	Open
Contact Type	Socket



Contact Mating Area Plating Material	Gold (Au)
--------------------------------------	-----------

Wire Contact Termination Area Plating Material	Tin
--	-----

Contact Retention Within Housing	With
----------------------------------	------

Contact Size	Size 16
--------------	---------

Contact Base Material	Brass
-----------------------	-------

Contact Current Rating (Max)	13 A
------------------------------	------

### Termination Features

Termination Method to Wire & Cable	Crimp
------------------------------------	-------

Product Terminates To	Wire & Cable
-----------------------	--------------

### Mechanical Attachment

Wire Insulation Support	With
-------------------------	------

Contact Retention Type Within Housing	Locking Spring
---------------------------------------	----------------

### Dimensions

Compatible Insulation Diameter Range	2.03 – 2.54 mm [.08 – .1 in]
--------------------------------------	------------------------------

Wire Size	.8 – 2 mm <sup>2</sup>
-----------	------------------------

### Usage Conditions

Operating Temperature Range	-55 – 150 °C [-67 – 302 °F]
-----------------------------	-----------------------------

### Operation/Application

Circuit Application	Power & Signal
---------------------	----------------

### Packaging Features

Packaging Quantity	12000
--------------------	-------

Packaging Method	Reel
------------------	------

### Product Compliance

[For compliance documentation, visit the product page on TE.com>](#)

EU RoHS Directive 2011/65/EU	Compliant
------------------------------	-----------

EU ELV Directive 2000/53/EC	Compliant
-----------------------------	-----------

China RoHS 2 Directive MIIT Order No 32, 2016	No Restricted Materials Above Threshold
---	---











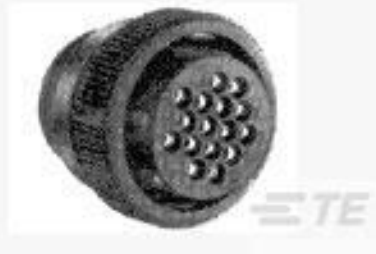

EU REACH Regulation (EC) No. 1907/2006	Current ECHA Candidate List: JAN 2025 (247) Candidate List Declared Against: JAN 2025 (247) Does not contain REACH SVHC
--	---

Halogen Content	Low Halogen - Br, Cl, F, I < 900 ppm per homogenous material. Also BFR/CFR/PVC Free
Solder Process Capability	Not applicable for solder process capability

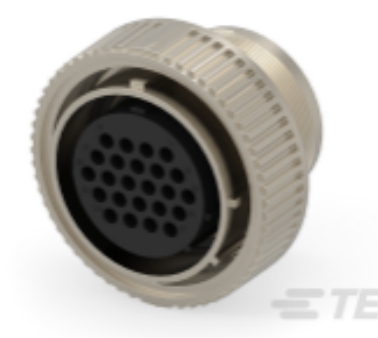
Product Compliance Disclaimer

This information is provided based on reasonable inquiry of our suppliers and represents our current actual knowledge based on the information they provided. This information is subject to change. The part numbers that TE has identified as EU RoHS compliant have a maximum concentration of 0.1% by weight in homogenous materials for lead, hexavalent chromium, mercury, PBB, PBDE, DBP, BBP, DEHP, DIBP, and 0.01% for cadmium, or qualify for an exemption to these limits as defined in the Annexes of Directive 2011/65/EU (RoHS2). Finished electrical and electronic equipment products will be CE marked as required by Directive 2011/65/EU. Components may not be CE marked. Additionally, the part numbers that TE has identified as EU ELV compliant have a maximum concentration of 0.1% by weight in homogenous materials for lead, hexavalent chromium, and mercury, and 0.01% for cadmium, or qualify for an exemption to these limits as defined in the Annexes of Directive 2000/53/EC (ELV). Regarding the REACH Regulation, the information TE provides on SVHC in articles for this part number is based on the latest European Chemicals Agency (ECHA) 'Guidance on requirements for substances in articles' posted at this URL: <https://echa.europa.eu/guidance-documents/guidance-on-reach>

## Compatible Parts

 <p>TE Part # 5-2151101-1 OCEAN_2.0_APPPLICATOR-S-090F120O-RSM</p>	 <p>TE Part # 5-2151101-2 OCEAN_2.0_APPPLICATOR-S-090F120O-RSA</p>	 <p>TE Part # 2151101-2 OCEAN_2.0_APPPLICATOR-S-090F120O-RSA</p>	 <p>TE Part # 1977884-1 SLD CPC PLUG ASSY,13-9,STD SEX, UV RESIS</p>
 <p>TE Part # 213851-1 CPC PLUG ASSEMBLY SIZE 23-24</p>	 <p>TE Part # 208714-1 CMC PLUG ASSEMBLY,SZ 14-7</p>	 <p>TE Part # 208457-3 CMC PLUG ASSEMBLY,SZ 28-24</p>	 <p>TE Part # 208488-1 CMC PLUG ASSEMBLY,SZ 22</p>
 <p>TE Part # 2305570-1 Strip Terminal Cutter-Side Feed-No Crimp</p>	 <p>TE Part # 539972-1 EXTRACTION TOOL</p>	 <p>TE Part # 796288-1 PLUG.ASSY,23-37STD SEX THRD AD</p>	 <p>TE Part # 796449-1 PLUG ASSY,CPC,17-14,REV SEX</p>



TE Part # 796450-1  
PLUG ASSY, CPC, 17-9, REV SEX



TE Part # 208488-3  
CMC PLUG ASSEMBLY, SZ 22



TE Part # 211766-1  
CPC PLUG ASSEMBLY SIZE 17-9



TE Part # 2151101-1  
OCEAN\_2.0\_APPLICATOR-S-090F120O-RSM



TE Part # 211772-1  
CPC PLUG ASSEMBLY SIZE 23-19



TE Part # 213852-1  
CPC PLUG ASSEMBLY SIZE 23-19



TE Part # 208714-2  
CMC PLUG ASSEMBLY, SZ 14-7



TE Part # 206060-1  
CPC PLUG ASSEMBLY SIZE 11-4

### Also in the Series | AMP Type III+



Connector Contacts(260)



Insertion & Extraction Tools(4)



Power Contacts(260)

### Also in the Series | Circular Plastic Connectors Series 1



Circular Power Connectors(211)



Connector Contacts(260)

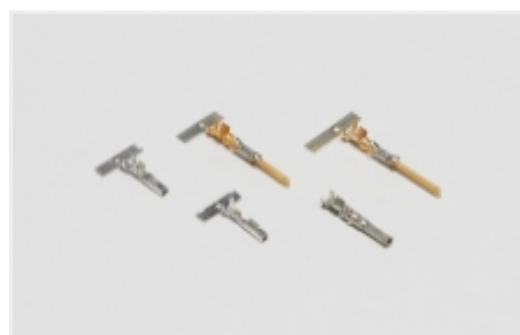

Power Contacts(260)

### Customers Also Bought

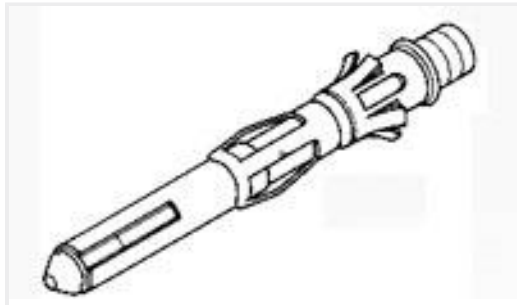

TE Part #226537-3  
SUB MIN PIN MULTI MATE

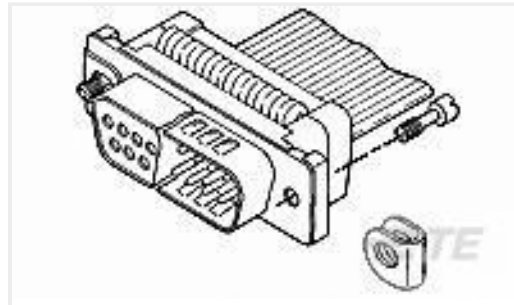

TE Part #5746881-2  
SCREW RETAINER KIT, BULK PKG

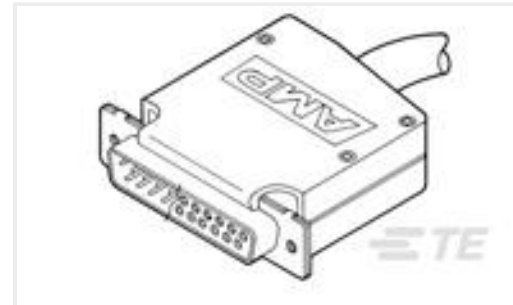

TE Part #5205732-1  
CLAMSHELL ASSEMBLY, SIZE 5



TE Part #165429-1  
SHUR PLUG REC. ASSY



TE Part #2292800-1  
AS16, PLUG BACKSHELL KIT, ST, 06P,  
SMOOTH



TE Part #61-0074-011-000  
CONTACT PIN 3.6 MM

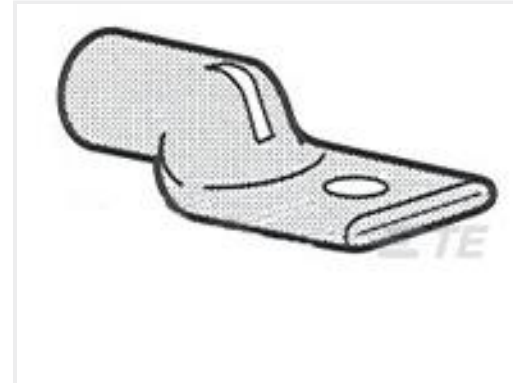

TE Part #325705  
TERMINAL, AMPPOWER 250MCM 1/2

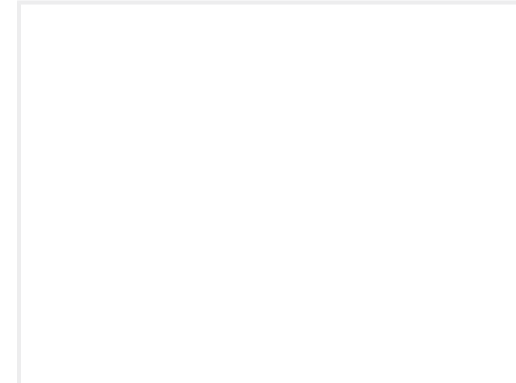

TE Part #HGA005N00003200000  
723 htec receptacle, angled, speedtec

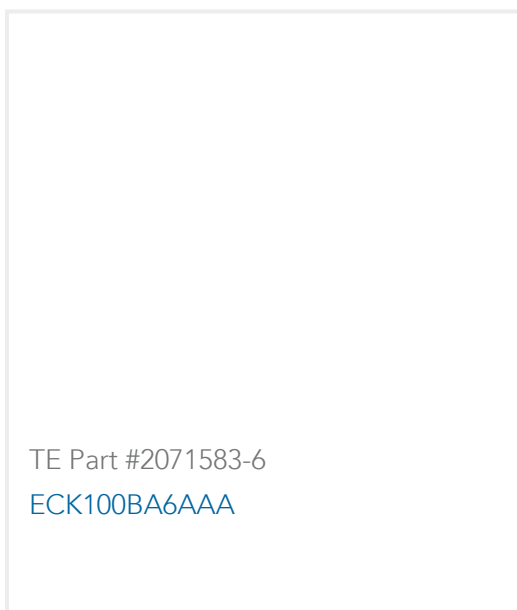

TE Part #2071583-6  
ECK100BA6AAA

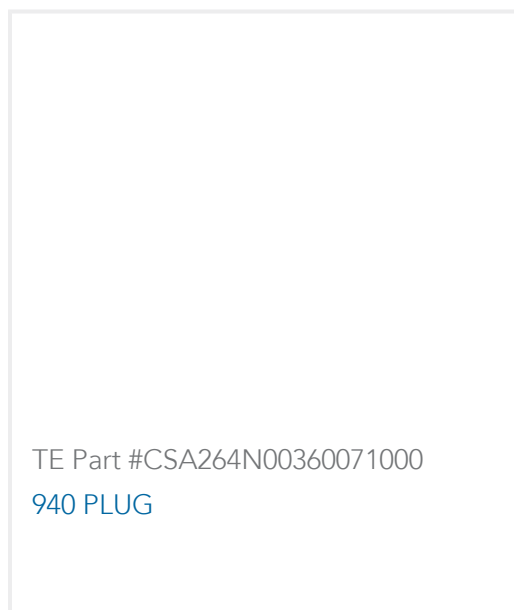

TE Part #CSA264N00360071000  
940 PLUG

## Documents

### Product Drawings

III+ SKT, 18-14, 15AU/FL, STRIP

English

### CAD Files

Customer View Model

[ENG\\_CVM\\_CVM\\_66358-9\\_AR.2d\\_dxf.zip](#)

English

### 3D PDF

3D

Customer View Model

[ENG\\_CVM\\_CVM\\_66358-9\\_AR.3d\\_igs.zip](#)

English

Customer View Model

[ENG\\_CVM\\_CVM\\_66358-9\\_AR.3d\\_stp.zip](#)

English

By downloading the CAD file I accept and agree to the [Terms and Conditions](#) of use.

## Datasheets & Catalog Pages



[AMP Circular Connectors for Commercial Signal & Power Applications](#)

English

[Signal Contacts](#)

English

[M\\_SERIES\\_PIN\\_AND\\_SOCKET\\_CONNECTORS](#)

English

---

[Product Specifications](#)

[Application Specification](#)

English

---

[Instruction Sheets](#)

[Instruction Sheet \(U.S.\)](#)

Japanese

[Instruction Sheet \(U.S.\)](#)

English