

66332-5 ✓ ACTIVE



AMP | Circular Plastic Connectors Series 1, AMP Type III+

TE Internal #: 66332-5

Pin Contact, Tin (Sn), Size 16 Contact Size, 24 – 20 AWG, .2 – .6 mm<sup>2</sup> Wire, Crimp, Brass, Power & Signal, -55 – 150 °C [-67 – 302 °F], AMP Type III+

[View on TE.com >](#)

Connectors > Contacts > Connector Contacts



Contact Type: **Pin**

Contact Mating Area Plating Material: **Tin (Sn)**

Wire Contact Termination Area Plating Material: **Tin-Lead**

Contact Retention Within Housing: **With**

Contact Size: **Size 16**

## Features

### Contact Features

Contact Underplating Material	Nickel
Contact Orientation	Straight
Mating Pin Diameter	1.57 mm[.062 in]
Contact Underplating Material Thickness	1.27 µm[50 µin]
Contact Mating Area Plating Material Thickness	2.54 µm[100 µin]
Wire Contact Termination Area Plating Material Finish	Matte
Wire Contact Termination Area Plating Thickness	2.54 µm[100 µin]
Contact Type	Pin
Contact Mating Area Plating Material	Tin (Sn)
Wire Contact Termination Area Plating Material	Tin-Lead
Contact Retention Within Housing	With
Contact Size	Size 16
Contact Base Material	Brass
Contact Current Rating (Max)	13 A



### Termination Features

Termination Method to Wire & Cable	Crimp
Product Terminates To	Wire & Cable

### Mechanical Attachment

Wire Insulation Support	With
-------------------------	------

### Dimensions

Compatible Insulation Diameter Range	2.03 – 2.54 mm [.08 – .1 in]
Wire Size	.2 – .6 mm <sup>2</sup>

### Usage Conditions

Operating Temperature Range	-55 – 150 °C [-67 – 302 °F]
-----------------------------	-----------------------------

### Operation/Application

Circuit Application	Power & Signal
---------------------	----------------

### Packaging Features

Packaging Quantity	4000
Packaging Method	Reel

### Product Compliance

[For compliance documentation, visit the product page on TE.com>](#)

EU RoHS Directive 2011/65/EU	Not Compliant
EU ELV Directive 2000/53/EC	Compliant with Exemptions
China RoHS 2 Directive MIIT Order No 32, 2016	Restricted Materials Above Threshold
EU REACH Regulation (EC) No. 1907/2006	Current ECHA Candidate List: JAN 2025 (247) Candidate List Declared Against: JAN 2025 (247) SVHC > Threshold: Pb (13% in 4690948374) <b>Article Safe Usage Statements:</b> Do not eat, drink or smoke when using this product. Wash thoroughly after handling. Recycle if possible and dispose of the article by following all applicable governmental regulations relevant to your geographic location.
Halogen Content	Low Halogen - Br, Cl, F, I < 900 ppm per homogenous material. Also BFR/CFR/PVC Free
Solder Process Capability	Not applicable for solder process capability

Product Compliance Disclaimer

This information is provided based on reasonable inquiry of our suppliers and represents our current actual knowledge based on the information they provided. This information is subject to change. The part numbers that TE has identified as EU RoHS compliant have a maximum concentration of 0.1% by weight in homogenous materials for lead, hexavalent chromium, mercury, PBB, PBDE, DBP, BBP, DEHP, DIBP, and 0.01% for cadmium, or qualify for an exemption to these limits as defined in the Annexes of Directive 2011/65/EU (RoHS2). Finished electrical and electronic equipment products will be CE marked as required by Directive 2011/65/EU. Components may not be CE marked. Additionally, the part numbers that TE has identified as EU ELV compliant have a maximum concentration of 0.1% by weight in homogenous materials for lead, hexavalent chromium, and mercury, and 0.01% for cadmium, or qualify for an exemption to these limits as defined in the Annexes of Directive 2000/53/EC (ELV). Regarding the REACH Regulation, the information TE provides on SVHC in articles for this part number is based on the latest European Chemicals Agency (ECHA) 'Guidance on requirements for substances in articles' posted at this URL: <https://echa.europa.eu/guidance-documents/guidance-on-reach>

## Compatible Parts



Also in the Series | **AMP Type III+**



Connector Contacts(260)

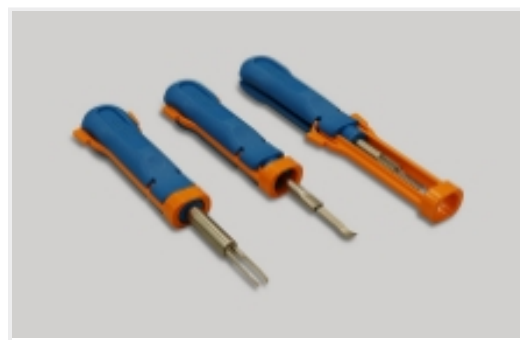

Insertion & Extraction Tools(4)



Power Contacts(260)

Also in the Series | **Circular Plastic Connectors Series 1**

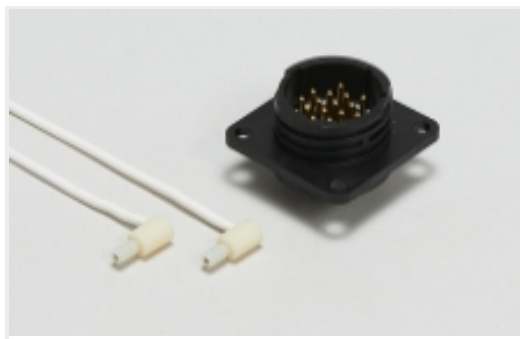

Circular Power Connectors(211)



Connector Contacts(260)



Power Contacts(260)

Customers Also Bought



**ANVIL** REPRESENTATION ONLY

TE Part #5-1803074-4  
ANVIL, COMBINATION, END FEED



TE Part #464281-1  
CRIMPER, SEMI-FLAT 16-14

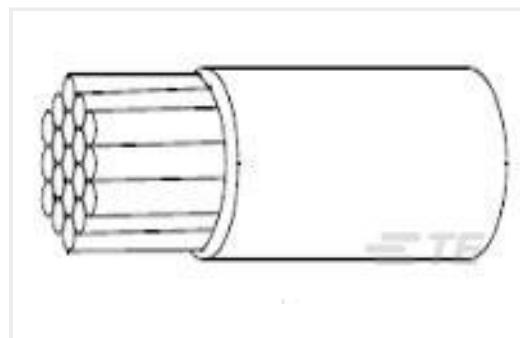

TE Part #216269-001  
22759/33-26-1



TE Part #521207-1  
POSI-LOK HSG.250-5 POS RAST5



TE Part #467342-3  
CRIMPER, RIGHT HAND



TE Part #456407-6  
CRIMPER WIRE .100

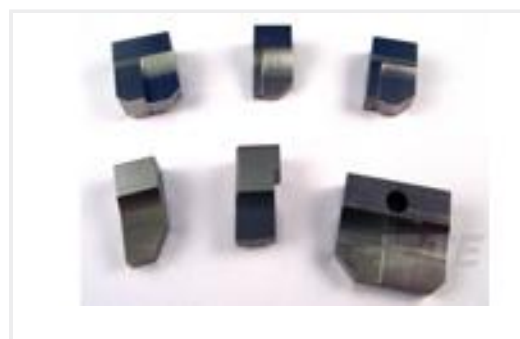

TE Part #464291-1  
ANVIL, SAND-BLASTED 22-18

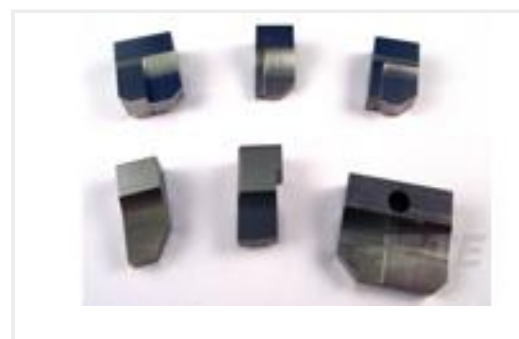

TE Part #464282-1  
ANVIL, SAND-BLASTED 16-14

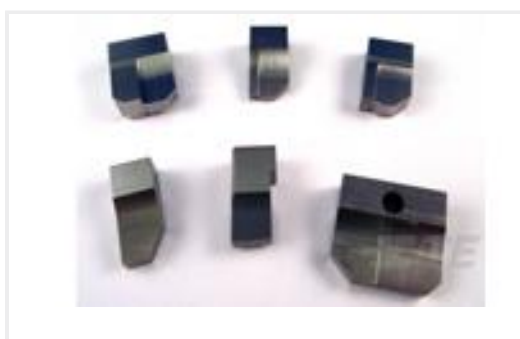

TE Part #240655-2  
ANVIL

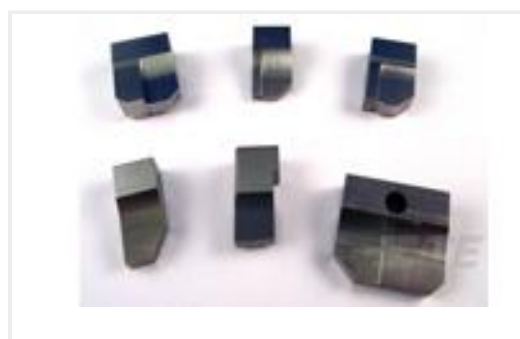

TE Part #5-240655-0  
ANVIL



## Documents

### Product Drawings

[III+ PIN,24-20,TIN-LEAD,STRIP](#)

English

---

### CAD Files

Customer View Model

[ENG\\_CVM\\_CVM\\_66332-5\\_AG.2d\\_dxf.zip](#)

English

3D PDF

3D

Customer View Model

[ENG\\_CVM\\_CVM\\_66332-5\\_AG.3d\\_igs.zip](#)

English

Customer View Model

[ENG\\_CVM\\_CVM\\_66332-5\\_AG.3d\\_stp.zip](#)

English

By downloading the CAD file I accept and agree to the [Terms and Conditions](#) of use.

---

### Product Specifications

[Application Specification](#)

English