

## CGS TE

TE Internal #: 6368150-3

RJ45 Connector, Single Port, 1 x 1, Jack, Shielded, Cat 5, Standard -  
Latch Down, 8 Position, Standard Profile, Through Hole - Solder,  
CGS TE

[View on TE.com >](#)

Connectors &gt; Modular Jacks &amp; Plugs &gt; RJ45 Connectors

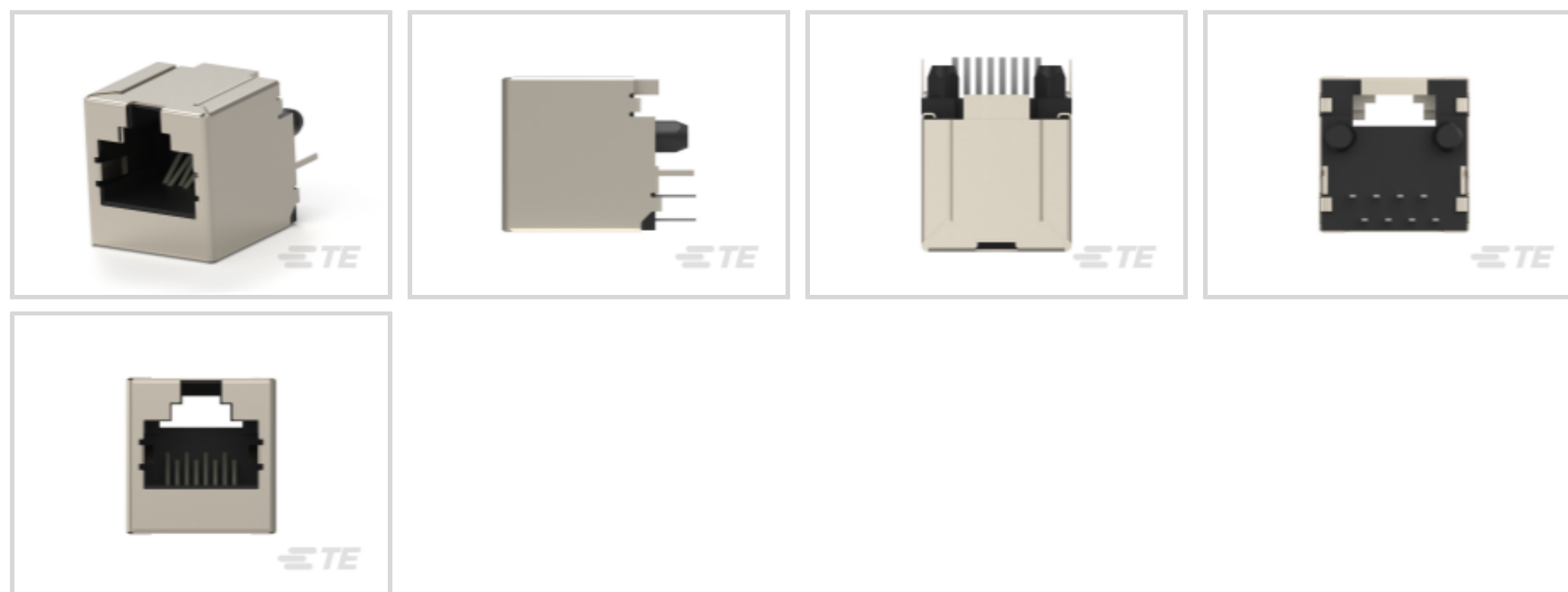
Modular Jack & Plug Interface Type: **RJ45**Port Configuration: **Single Port**Port Matrix Configuration: **1 x 1**Modular Jacks & Plugs Products: **RJ Type Jacks & Plugs**Connector Contact Density: **Standard**

## Features

### Product Type Features

Connector Product Type	Connector Assembly
Modular Jack & Plug Interface Type	RJ45
Modular Jacks & Plugs Products	RJ Type Jacks & Plugs
Modular Connector Style	Jack
Grounding Options	PCB Ground
Connector & Contact Terminates To	Printed Circuit Board

### Configuration Features

Number of PCB Ground Tabs	2
Port Configuration	Single Port
Port Matrix Configuration	1 x 1
Connector Contact Density	Standard
Number of Positions	8
Number of Loaded Positions	8
PCB Mount Orientation	Vertical



### Body Features

Shield Plating Material	Tin
Shield Material	Copper Alloy
PCB Ground Tab Location	3.89 mm[.153 in]
Modular Jack Latch Orientation	Standard - Latch Down
Connector Profile	Standard

### Contact Features

Contact Underplating Material	Nickel
PCB Contact Termination Area Plating Material	Tin
Contact Current Rating (Max)	1.5 A
Contact Mating Area Plating Material	Gold (Au)
Contact Base Material	Phosphor Bronze

### Termination Features

Termination Method to PCB	Through Hole - Solder
Termination Post & Tail Length	3.99 mm[.157 in]

### Mechanical Attachment

Panel Mount Feature	With
Connector Mounting Type	Board Mount, Panel Mount

### Housing Features

Mating Entry Location	Top
Centerline (Pitch)	1.02 mm[.04 in]
Housing Color	Black
Housing Material	High Temperature Thermoplastic

### Dimensions

PCB Thickness (Recommended)	1.57 mm[.062 in]
Connector Height	16.82 mm[.662 in]

### Usage Conditions

Operating Temperature Range	-40 – 85 °C[-40 – 185 °F]
-----------------------------	---------------------------

### Operation/Application

Indicator Type	No Indicator
Shielded	Yes
Circuit Application	Signal



### Industry Standards

UL Flammability Rating	UL 94V-0
Performance Category	Cat 5

### Packaging Features

Packaging Quantity	29
Packaging Method	Box, Box & Tube

### Product Compliance

[For compliance documentation, visit the product page on TE.com>](#)

EU RoHS Directive 2011/65/EU	Compliant
EU ELV Directive 2000/53/EC	Compliant
China RoHS 2 Directive MIIT Order No 32, 2016	No Restricted Materials Above Threshold
EU REACH Regulation (EC) No. 1907/2006	Current ECHA Candidate List: JAN 2025 (247) Candidate List Declared Against: JUNE 2024 (241) Does not contain REACH SVHC
Halogen Content	Low Halogen - Br, Cl, F, I < 900 ppm per homogenous material. Also BFR/CFR/PVC Free
Solder Process Capability	Not applicable for solder process capability

#### Product Compliance Disclaimer

This information is provided based on reasonable inquiry of our suppliers and represents our current actual knowledge based on the information they provided. This information is subject to change. The part numbers that TE has identified as EU RoHS compliant have a maximum concentration of 0.1% by weight in homogenous materials for lead, hexavalent chromium, mercury, PBB, PBDE, DBP, BBP, DEHP, DIBP, and 0.01% for cadmium, or qualify for an exemption to these limits as defined in the Annexes of Directive 2011/65/EU (RoHS2). Finished electrical and electronic equipment products will be CE marked as required by Directive 2011/65/EU. Components may not be CE marked. Additionally, the part numbers that TE has identified as EU ELV compliant have a maximum concentration of 0.1% by weight in homogenous materials for lead, hexavalent chromium, and mercury, and 0.01% for cadmium, or qualify for an exemption to these limits as defined in the Annexes of Directive 2000/53/EC (ELV). Regarding the REACH Regulation, the information TE provides on SVHC in articles for this part number is based on the latest European Chemicals Agency (ECHA) 'Guidance on requirements for substances in articles' posted at this URL: <https://echa.europa.eu/guidance-documents/guidance-on-reach>

### Compatible Parts

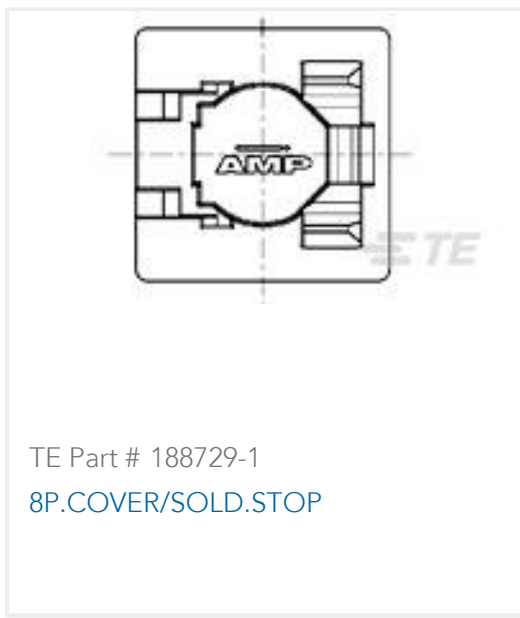

### Also in the Series | CGS TE

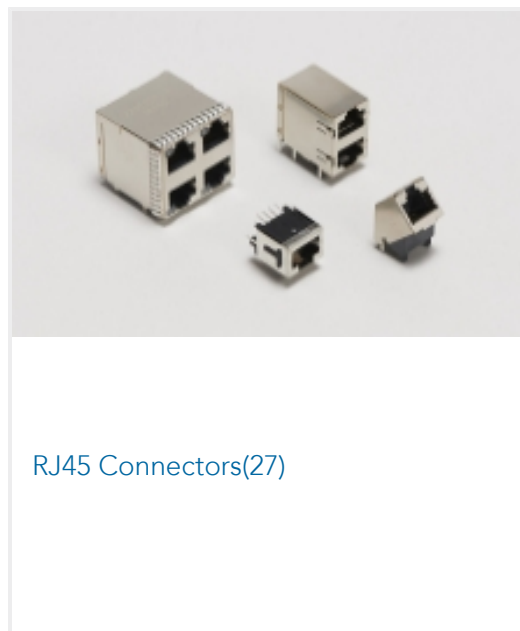
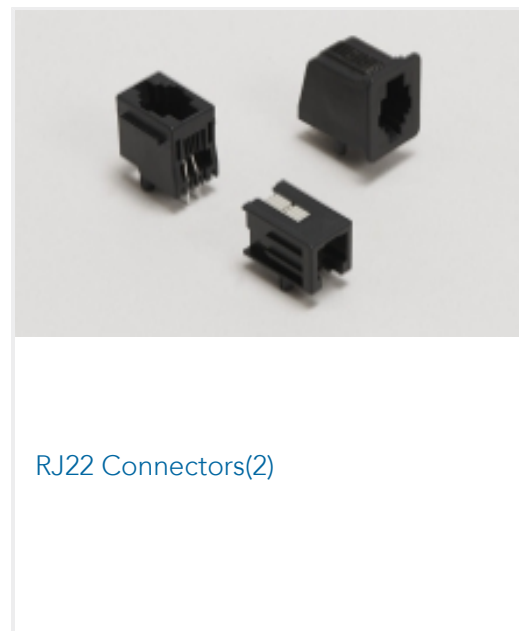
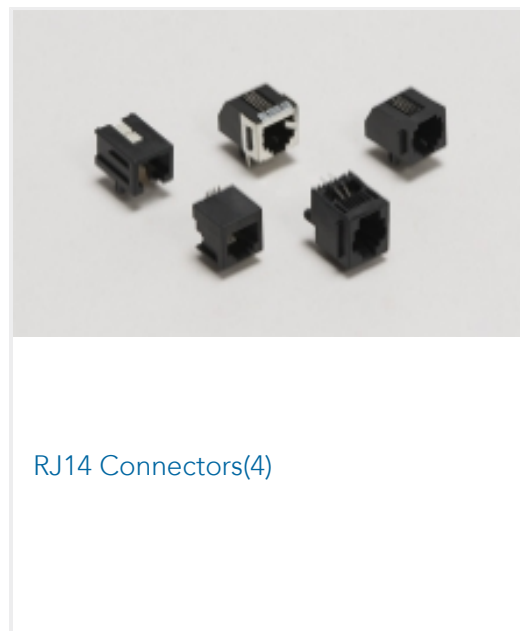

### Customers Also Bought

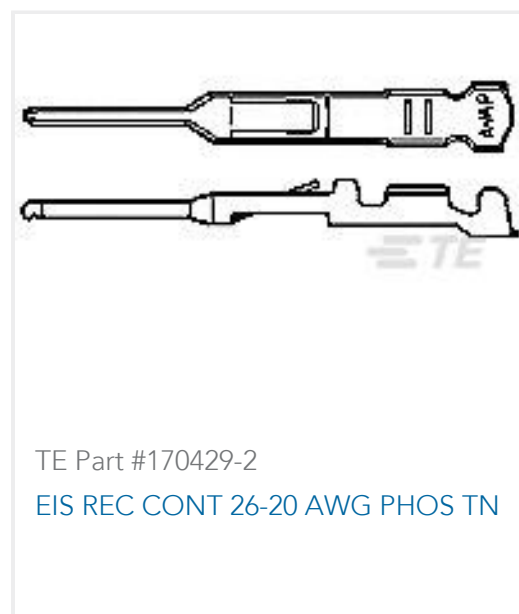

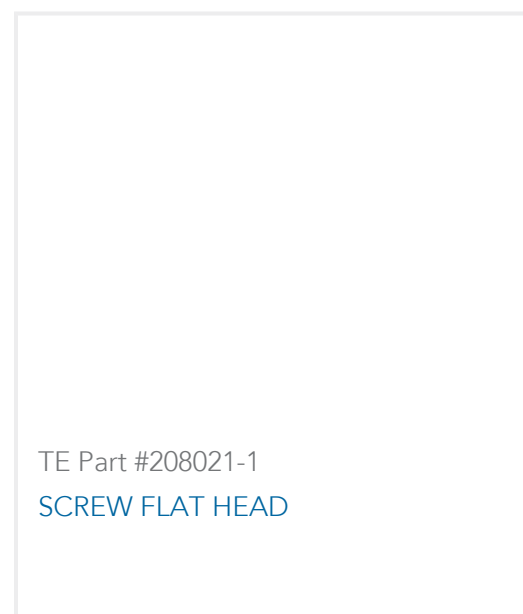

## Documents

### CAD Files

#### 3D PDF

3D

#### Customer View Model

[ENG\\_CVM\\_CVM\\_6368150-3\\_A.2d\\_dxf.zip](#)

English

#### Customer View Model

[ENG\\_CVM\\_CVM\\_6368150-3\\_A.3d\\_igs.zip](#)

English

#### Customer View Model

[ENG\\_CVM\\_CVM\\_6368150-3\\_A.3d\\_stp.zip](#)

English

By downloading the CAD file I accept and agree to the [Terms and Conditions](#) of use.

### Product Specifications

#### Product Specification

English