

52041 ✓ ACTIVE

PLASTI-GRIP

TE Internal #: 52041

Closed Ring Tongue Terminal, 8 AWG, #8 / M4 Stud, 4.34 mm [.171 in] Stud Diameter, Closed Barrel, Straight, Tin Plating, PLASTI-GRIP

[View on TE.com >](#)



Terminals & Splices > Ring Terminals

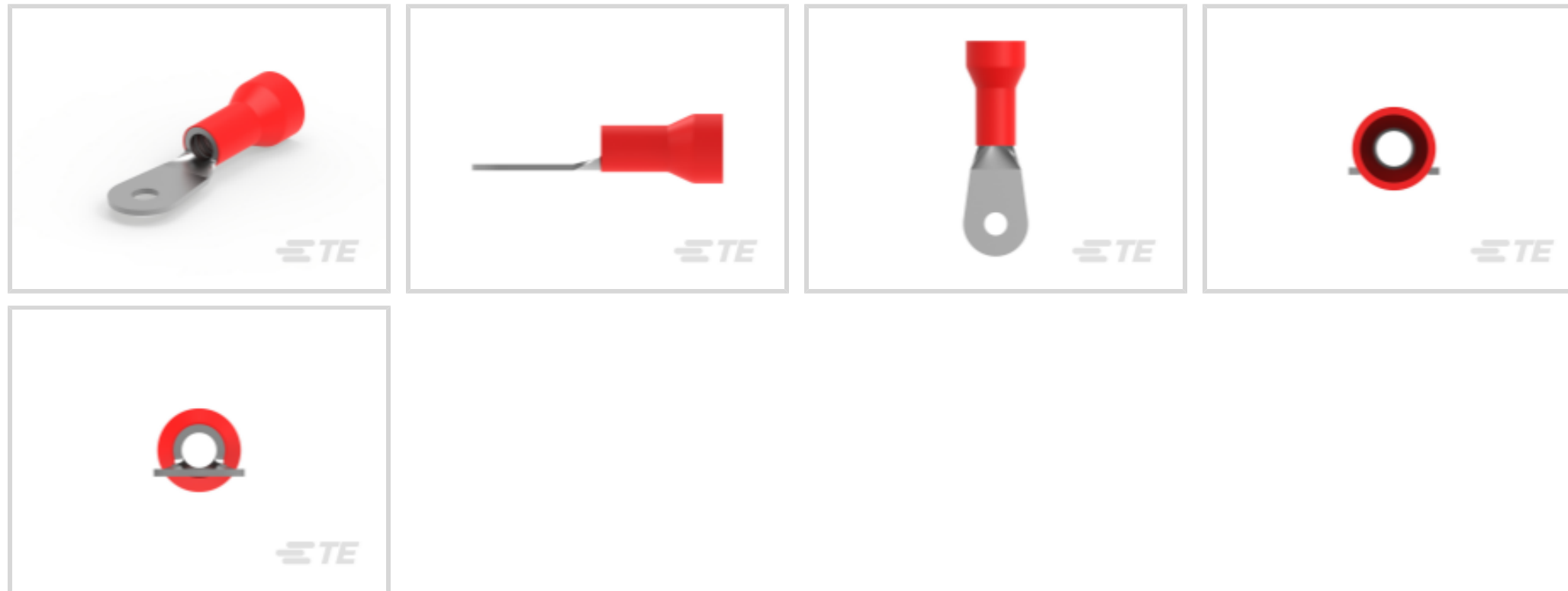

Ring Terminal Product Type: Closed Ring Tongue Terminal

Wire Size: 13100 – 20800 CMA

Stud Size: #8, M4

Features

Product Type Features

Ring Terminal Product Type	Closed Ring Tongue Terminal
Stud Size	#8, M4
Sealable	No
Wire Insulation Support Retention Type	Insulation Support

Configuration Features

Number of Holes	1
-----------------	---

Electrical Characteristics

Voltage Rating	600 V
----------------	-------

Contact Features

Barrel Type	Closed
Terminal Orientation	Straight
Terminal Plating Material	Tin

Mechanical Attachment

Wire Insulation Support	With
-------------------------	------

Dimensions

--	--



Wire Size	13100 – 20800 CMA
Stud Diameter	4.34 mm [.171 in]
Tongue Thickness	1.02 mm [.04 in]
Product Length	40.28 mm [1.586 in]
Compatible Insulation Diameter (Max)	9.14 mm [.36 in]
Compatible Insulation Diameter Range	9.14 mm [.36 in]

Usage Conditions

Insulation Option	Partially Insulated
-------------------	---------------------

Operation/Application

Compatible With Wire Base Material	Copper
Compatible With Wire Plating Material	Tin

Industry Standards

Government Qualified Terminal	No
-------------------------------	----

Packaging Features

Packaging Quantity	100
Packaging Method	Loose Piece

Product Compliance

[For compliance documentation, visit the product page on TE.com>](#)

EU RoHS Directive 2011/65/EU	Compliant
EU ELV Directive 2000/53/EC	Compliant
China RoHS 2 Directive MIIT Order No 32, 2016	No Restricted Materials Above Threshold
EU REACH Regulation (EC) No. 1907/2006	Current ECHA Candidate List: JAN 2025 (247) Candidate List Declared Against: JUNE 2024 (241) Does not contain REACH SVHC
Halogen Content	Not Low Halogen - contains Br or Cl > 900 ppm.
Solder Process Capability	Not applicable for solder process capability

Product Compliance Disclaimer

This information is provided based on reasonable inquiry of our suppliers and represents our current actual knowledge based on the information they provided. This information is subject to change. The part numbers that TE has identified as EU RoHS compliant have a maximum concentration of 0.1% by weight in homogenous materials for lead, hexavalent chromium, mercury, PBB, PBDE, DBP, BBP, DEHP, DIBP, and 0.01% for cadmium, or qualify for an exemption to these limits as defined in the Annexes of Directive 2011/65/EU (RoHS2). Finished electrical and electronic equipment products

will be CE marked as required by Directive 2011/65/EU. Components may not be CE marked. Additionally, the part numbers that TE has identified as EU ELV compliant have a maximum concentration of 0.1% by weight in homogenous materials for lead, hexavalent chromium, and mercury, and 0.01% for cadmium, or qualify for an exemption to these limits as defined in the Annexes of Directive 2000/53/EC (ELV). Regarding the REACH Regulation, the information TE provides on SVHC in articles for this part number is based on the latest European Chemicals Agency (ECHA) 'Guidance on requirements for substances in articles' posted at this URL: <https://echa.europa.eu/guidance-documents/guidance-on-reach>

Compatible Parts



TE Part # 1490534-1
HYP10 PLASTI-GRIP 8AWG DIE SET



TE Part # 1490597-1
HYP10 TERMINYL 8AWG DIE SET



TE Part # 47820
HYP8 TERMINYL 8AWG DIE SET

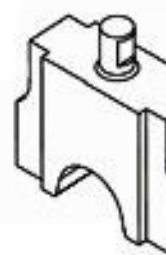

TE Part # 1901006-1
ASSEMBLY, TERMINYL DIE #8



TE Part # 48752-1
HYP8 PLASTI-GRIP 8AWG 69051 DIE SET



TE Part # 69959
HHHT AMPLI-BOND PG 8 ASSY SET

Also in the Series | PLASTI-GRIP



Compression Connectors(3)



Crimp Wire Pins, Tabs & Ferrules(20)



Ring Terminals(310)



Spade Terminals(158)



Splices(45)

Customers Also Bought

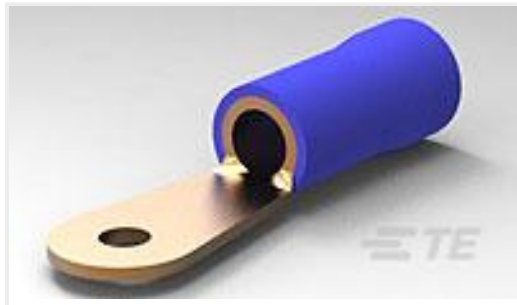

TE Part #52042
TERMINAL,R PG 6 8



TE Part #2-325034-1
TERMINAL,PIDG R 16-14 1/4



TE Part #63864-1
RING AMVAR IS 2(13) 025TPBR



TE Part #640457-7
07P MTA100 HDR ASSY SQ R/A F/L



TE Part #60319-2
AMPLIVAR RG 23-19 10 TPBR



TE Part #324523
TERMINAL,DG R 12-10 8



TE Part #61793-1
RING 18-14 AWG TPST

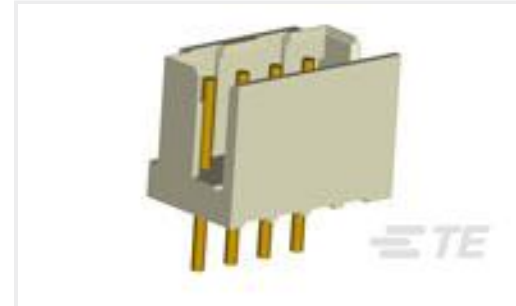

TE Part #292132-4
CT P/HDR BOX V 4P NAT

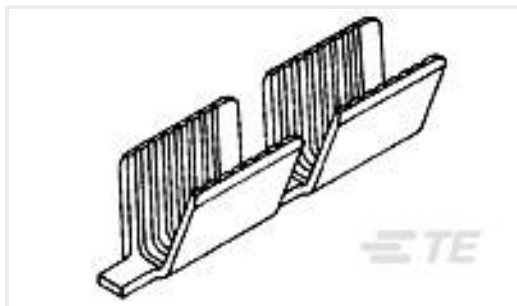

TE Part #62040-1
SPLC AMVAR 1500-5000 020TPBR

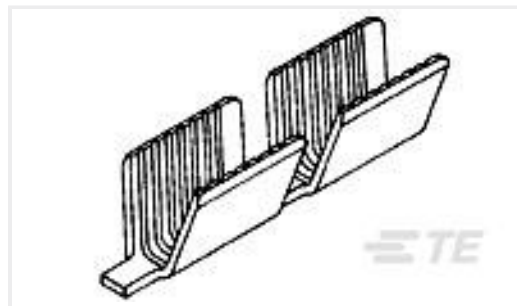

TE Part #62001-1
SPLICE AMVAR 3000-7000 020BR

Documents

Product Drawings

[TERMINAL,R PG 8 8](#)

English

CAD Files

[3D PDF](#)

3D

Customer View Model

[ENG_CVM_CVM_52041_Y.2d_dxf.zip](#)

English

Customer View Model

[ENG_CVM_CVM_52041_Y.3d_igs.zip](#)

English

Customer View Model

[ENG_CVM_CVM_52041_Y.3d_stp.zip](#)

English

[3D PDF](#)

English



Customer View Model

[ENG_CVM_52041_R1.2d_dxf.zip](#)

English

Customer View Model

[ENG_CVM_52041_R1.3d_igs.zip](#)

English

Customer View Model

[ENG_CVM_52041_R1.3d_stp.zip](#)

English

By downloading the CAD file I accept and agree to the [Terms and Conditions](#) of use.

Product Specifications

[Application Specification](#)

English

Instruction Sheets

[Instruction Sheet \(U.S.\)](#)

English

Agency Approvals

[UL Report](#)

English

[UL Report](#)

English