

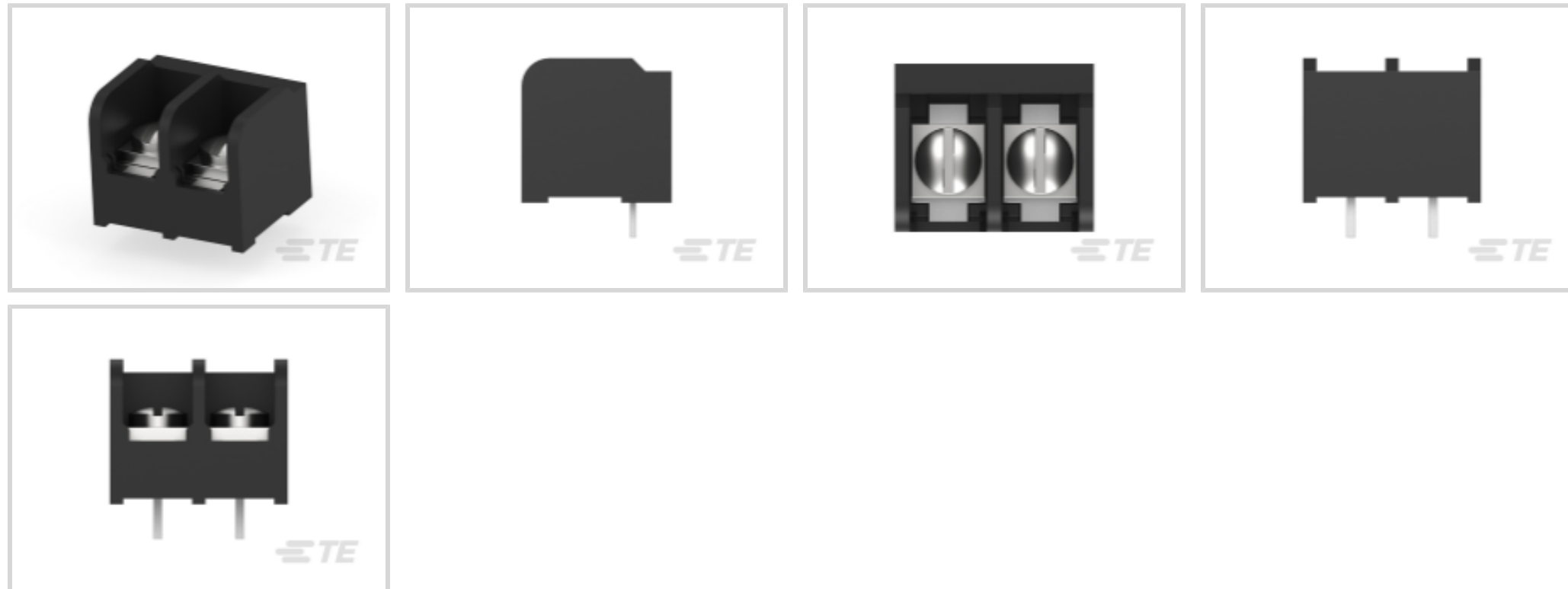

Connectors > Terminal Blocks & Strips > Barrier Strips



Number of Positions: 2

Barrier Strip Style: **Tri-Barrier**

Bottom Termination Type: **Printed Circuit Pin**

Connector System: **Wire-to-Board**

Centerline (Pitch): 11.1 mm [.438 in]

Features

Product Type Features

Block Style	Flat Bottom with standoffs
Connector System	Wire-to-Board
Connector & Contact Terminates To	Printed Circuit Board

Configuration Features

Number of Levels	1
Number of Positions	2
Number of Rows	1

Electrical Characteristics

Operating Voltage	600 V
-------------------	-------

Body Features

Primary Product Color	Black
Product Orientation	Vertical
Barrier Strip Style	Tri-Barrier

Contact Features

Contact Base Material	Copper Alloy
PCB Contact Termination Area Plating Material	Tin
Contact Current Rating (Max)	30 A

Termination Features

Bottom Termination Type	Printed Circuit Pin
-------------------------	---------------------

Mechanical Attachment

Top Termination Type	Wire Clamp Combo Head
Mounting Options	None
Screw Plating Material	Zinc
Screw Material	Steel
Thread Size	8-32
Screw Head Type	Wire Clamp Combo Head
Connector Mounting Type	Board Mount

Housing Features

Housing Material	Thermoplastic
Centerline (Pitch)	11.1 mm [.438 in]

Dimensions

Product Length	24.07 mm [.948 in]
Wire Size	18 – 10 AWG, 22 – 10 AWG

Usage Conditions

Operating Temperature Range	-40 – 120 °C [-40 – 248 °F]
-----------------------------	-----------------------------

Operation/Application

Circuit Application	Power
---------------------	-------

Industry Standards

UL Flammability Rating	UL 94V-0
------------------------	----------

Packaging Features

Packaging Method	Package
Packaging Quantity	270

Product Compliance

For compliance documentation, visit the product page on [TE.com](#)>



EU RoHS Directive 2011/65/EU	Compliant
EU ELV Directive 2000/53/EC	Out of Scope
China RoHS 2 Directive MIIT Order No 32, 2016	No Restricted Materials Above Threshold
EU REACH Regulation (EC) No. 1907/2006	Current ECHA Candidate List: JAN 2025 (247) Candidate List Declared Against: JAN 2025 (247) Does not contain REACH SVHC
Halogen Content	Not Low Halogen - contains Br or Cl > 900 ppm.
Solder Process Capability	Wave solder capable to 265°C

Product Compliance Disclaimer

This information is provided based on reasonable inquiry of our suppliers and represents our current actual knowledge based on the information they provided. This information is subject to change. The part numbers that TE has identified as EU RoHS compliant have a maximum concentration of 0.1% by weight in homogenous materials for lead, hexavalent chromium, mercury, PBB, PBDE, DBP, BBP, DEHP, DIBP, and 0.01% for cadmium, or qualify for an exemption to these limits as defined in the Annexes of Directive 2011/65/EU (RoHS2). Finished electrical and electronic equipment products will be CE marked as required by Directive 2011/65/EU. Components may not be CE marked. Additionally, the part numbers that TE has identified as EU ELV compliant have a maximum concentration of 0.1% by weight in homogenous materials for lead, hexavalent chromium, and mercury, and 0.01% for cadmium, or qualify for an exemption to these limits as defined in the Annexes of Directive 2000/53/EC (ELV). Regarding the REACH Regulation, the information TE provides on SVHC in articles for this part number is based on the latest European Chemicals Agency (ECHA) 'Guidance on requirements for substances in articles' posted at this URL: <https://echa.europa.eu/guidance-documents/guidance-on-reach>

Compatible Parts

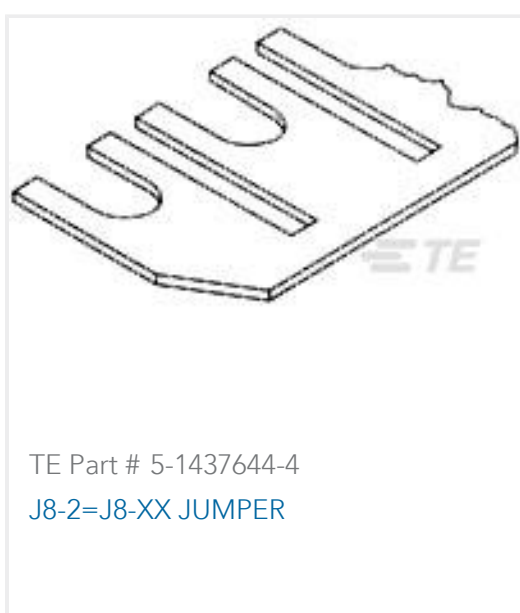

Also in the Series | BUCHANAN 8 Series

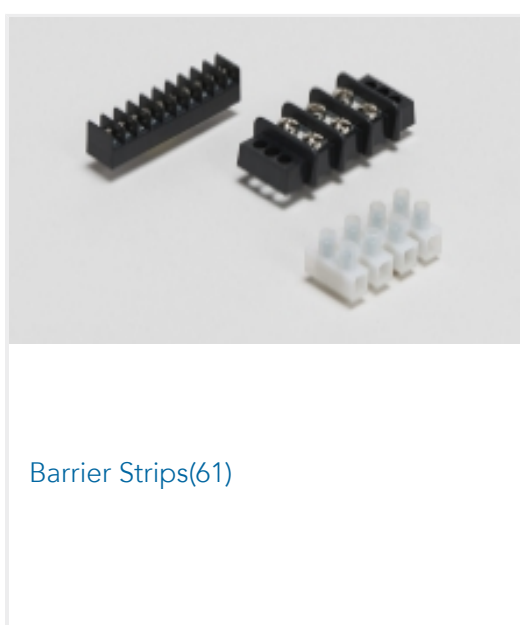

Customers Also Bought

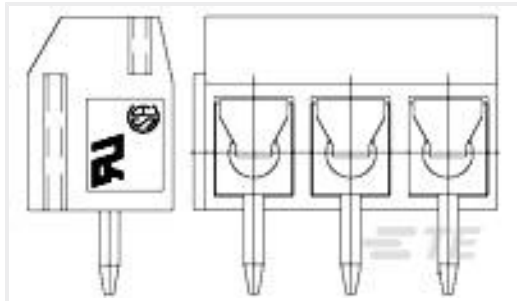

TE Part #1776244-6
6P TB ,90deg, VT, 5mm, Blue,w
/interlock



TE Part #350829-4
12P UMNL HDR ASSY PC 94VO LF

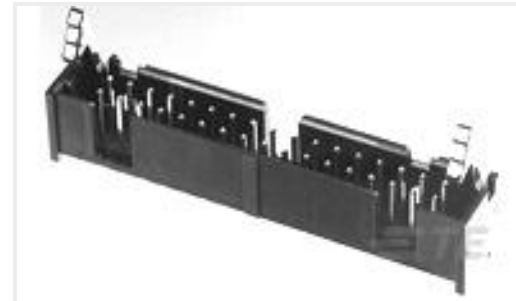

TE Part #3-1761606-1
IDC LOW PRO HDR 34P VERT LA



TE Part #5103309-6
A/L LOW PRO HDR 26P VERT BLACK



TE Part #207890-2
CPC RECPT REV SEX 23-37

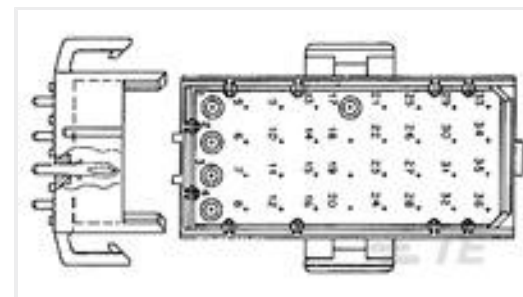

TE Part #2-640497-4
02P MR HDR ASSY



TE Part #1-640453-1
11P MTA100 HDR ASSY SQ R/A

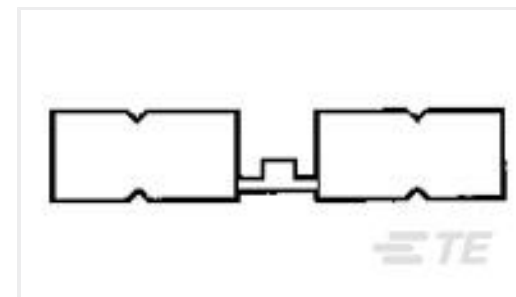

TE Part #1-322346-0
DG 16-14 HT ALUMEL BUTT

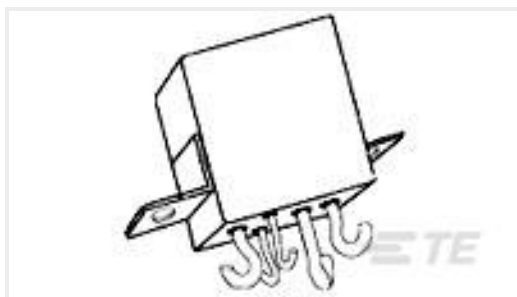

TE Part #5-1617748-8
FCA-125-9=M6106/19-009



TE Part #7-2176091-4
RP 2A 0.25W 348R 0.1% 25PPM 1K RL

Documents

CAD Files

Customer View Model

[ENG_CVM_CVM_5-1437657-7_R1.3d_stp.zip](#)

English

Customer View Model

[ENG_CVM_CVM_5-1437657-7_R1.2d_dxf.zip](#)

English

Customer View Model

[ENG_CVM_CVM_5-1437657-7_R1.3d_igs.zip](#)

English

3D PDF

3D

By downloading the CAD file I accept and agree to the [Terms and Conditions](#) of use.