

5-1241967-8 ✓ ACTIVE

[RAST | RAST 5 IDC Connectors](#)

TE Internal #: 5-1241967-8

Housing, Plug, Wire-to-Wire, 8 Position, 5 mm [.197 in] Centerline, Crimp, 1 Row, Natural, Wire & Cable, Power, Panel Mount, RAST 5 IDC Connectors

[View on TE.com >](#)



Connectors > PCB Connectors > Wire-to-Board Connectors > Wire-to-Board Connector Assemblies & Housings

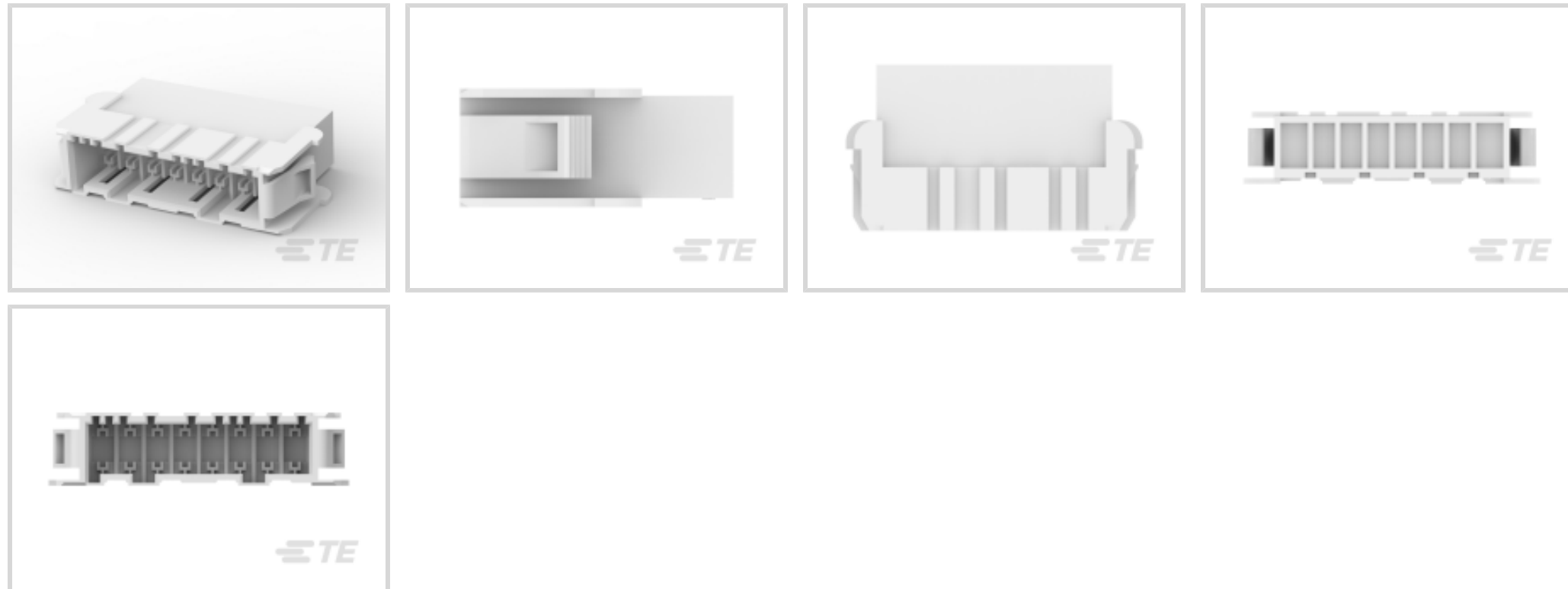

Connector Product Type: **Housing**

Connector & Housing Type: **Plug**

Connector System: **Wire-to-Wire**

Number of Positions: **8**

Centerline (Pitch): **5 mm [.197 in]**

Features

Product Type Features

Connector Product Type	Housing
Connector & Housing Type	Plug
Connector System	Wire-to-Wire
Sealable	No
Connector & Contact Terminates To	Wire & Cable

Configuration Features

Number of Positions	8
Number of Rows	1

Body Features

Primary Product Color	Natural
-----------------------	---------

Termination Features

Termination Method to Wire & Cable	Crimp
------------------------------------	-------

Mechanical Attachment

--	--



Panel Mount Feature	With
Mating Retention Type	Locking
Panel Mount Feature Type	Latches
Mating Retention	With
Connector Mounting Type	Panel Mount

Housing Features

Centerline (Pitch)	5 mm [.197 in]
--------------------	----------------

Usage Conditions

Operating Temperature Range	-25 – 105 °C [-13 – 221 °F]
-----------------------------	-----------------------------

Operation/Application

Circuit Application	Power
---------------------	-------

Product Compliance

[For compliance documentation, visit the product page on TE.com>](#)

EU RoHS Directive 2011/65/EU	Compliant
EU ELV Directive 2000/53/EC	Compliant
China RoHS 2 Directive MIIT Order No 32, 2016	No Restricted Materials Above Threshold
EU REACH Regulation (EC) No. 1907/2006	Current ECHA Candidate List: JAN 2025 (247) Candidate List Declared Against: JAN 2025 (247) Does not contain REACH SVHC
Halogen Content	Not Low Halogen - contains Br or Cl > 900 ppm.
Solder Process Capability	Not applicable for solder process capability

Product Compliance Disclaimer

This information is provided based on reasonable inquiry of our suppliers and represents our current actual knowledge based on the information they provided. This information is subject to change. The part numbers that TE has identified as EU RoHS compliant have a maximum concentration of 0.1% by weight in homogenous materials for lead, hexavalent chromium, mercury, PBB, PBDE, DBP, BBP, DEHP, DIBP, and 0.01% for cadmium, or qualify for an exemption to these limits as defined in the Annexes of Directive 2011/65/EU (RoHS2). Finished electrical and electronic equipment products will be CE marked as required by Directive 2011/65/EU. Components may not be CE marked. Additionally, the part numbers that TE has identified as EU ELV compliant have a maximum concentration of 0.1% by weight in homogenous materials for lead, hexavalent chromium, and mercury, and 0.01% for cadmium, or qualify for an exemption to these limits as defined in the Annexes of Directive 2000/53/EC (ELV). Regarding the REACH Regulation, the information TE provides on SVHC in articles for this part number is based on the latest European Chemicals Agency (ECHA) 'Guidance on requirements for substances in articles' posted at this URL: <https://echa.europa.eu/guidance-documents/guidance-on-reach>

Compatible Parts



Also in the Series | RAST 5 IDC Connectors

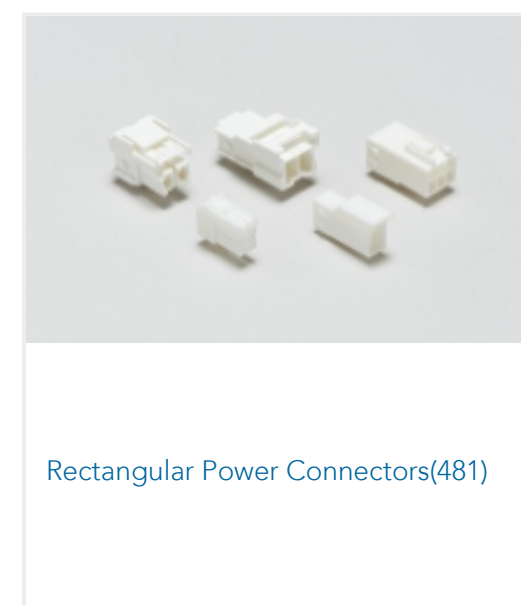
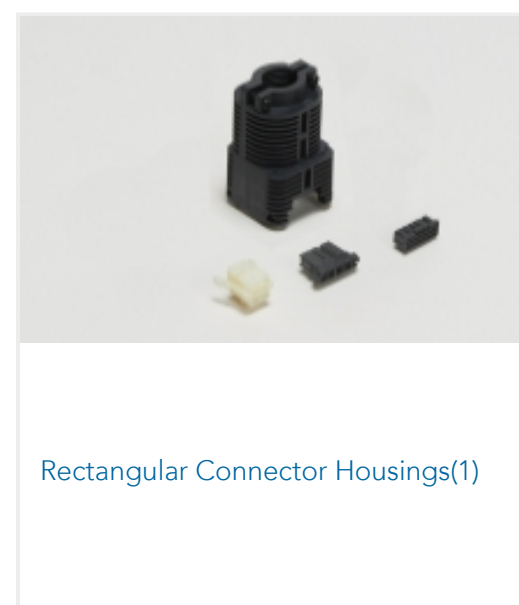
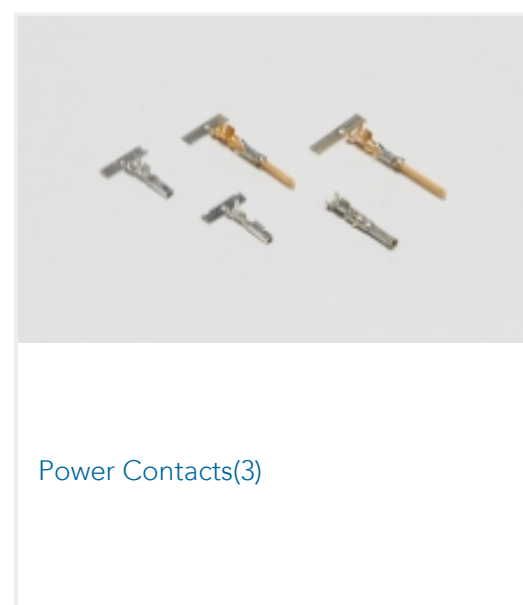
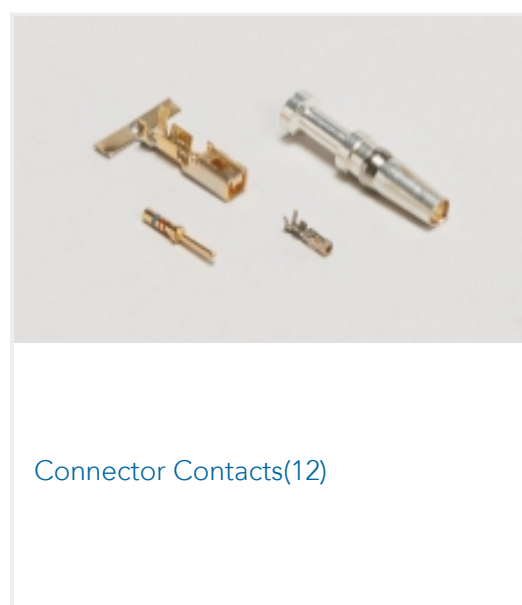

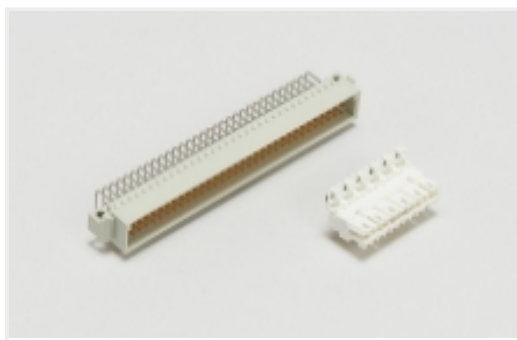

Standard Edge Connectors(31)



Wire-to-Board Connector Assemblies & Housings(197)

Customers Also Bought



TE Part #1-967627-4
FLACHSTE-GEH2,8 12P



TE Part #1217092-2
PL 250 TERMINAL REC 16-12 AWG TPBR



TE Part #1-2315715-2
M12 X-CODE F-8 CON 8.4MM, TE



TE Part #1-1718492-4
1.5MM TAB HSG 36 POS ASSY



TE Part #927742-4
4 POS FASTIN/ON HOUSING PANEL MOUNT



TE Part #9-1241961-9
STANDARD TIMER HOUSING MK II

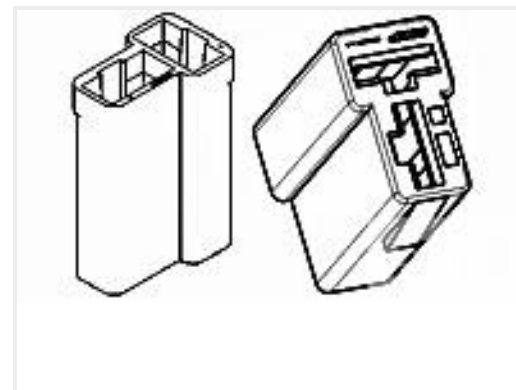

TE Part #180907
FF 250 REC HSG 2P NYLON NAT



TE Part #1534415-6
DUOPL POW FEM CON6P



TE Part #2-1241961-8
STD TIM HOUSING MKII 3POS



TE Part #4-160256-2
250 FASTON,REC.,17-14 AWG,PNST

Documents

Product Drawings

[FASTIN FASTON TAB HOUSING 8P](#)

English

CAD Files

Customer View Model

[ENG_CVM_CVM_5-1241967-8_B.2d_dxf.zip](#)

English

[3D PDF](#)



3D

Customer View Model

[ENG_CVM_CVM_5-1241967-8_B.3d_igs.zip](#)

English

Customer View Model

[ENG_CVM_CVM_5-1241967-8_B.3d_stp.zip](#)

English

By downloading the CAD file I accept and agree to the [Terms and Conditions](#) of use.

Datasheets & Catalog Pages

[FASTIN_FASTON_Product_Line](#)

English

[RAST Connector System Catalog](#)

English

Product Specifications

[QUALIFICATION TEST REPORT FOR 2-12 POS. FASTIN-FASTON* TAB HSG, RAST 5, PANEL MOUNT.](#)

English

English

Agency Approvals

[Agency Approval Document](#)

English