

480115-3 ✓ ACTIVE

FASTIN-FASTON | FASTIN-FASTON 250

TE Internal #: 480115-3

Receptacle, Receptacle, 2 Position, Straight, UL 94V-2, Black, Nylon,
Cable Mount (Free-Hanging), Carton, FASTIN-FASTON 250, Crimp
Terminal Housings

[View on TE.com >](#)



Terminals & Splices > Terminal Housings, Insulation Sleeves & Blocks > Crimp Terminal Housings



Terminal Type: **Receptacle**

Connector & Housing Type: **Receptacle**

Number of Positions: **2**

Terminal Orientation: **Straight**

UL Flammability Rating: **UL 94V-2**

Features

Product Type Features

Sealable	No
Connector & Housing Type	Receptacle

Configuration Features

Number of Positions	2
---------------------	---

Body Features

Primary Product Color	Black
-----------------------	-------

Contact Features

Terminal Type	Receptacle
Terminal Orientation	Straight
Contact Mating Retention	Without

Mechanical Attachment

Mating Alignment	With
Connector Mounting Type	Cable Mount (Free-Hanging)



Housing Features

Housing Material	Nylon
Centerline (Pitch)	7.7 mm[.303 in]

Dimensions

Product Length	23.1 mm[.91 in]
----------------	-----------------

Usage Conditions

Operating Temperature Range	-40 – 105 °C[-40 – 221 °F]
-----------------------------	----------------------------

Industry Standards

UL Flammability Rating	UL 94V-2
------------------------	----------

Packaging Features

Packaging Quantity	1
Packaging Method	Carton

Product Compliance

[For compliance documentation, visit the product page on TE.com>](#)

EU RoHS Directive 2011/65/EU	Compliant
EU ELV Directive 2000/53/EC	Compliant
China RoHS 2 Directive MIIT Order No 32, 2016	No Restricted Materials Above Threshold
EU REACH Regulation (EC) No. 1907/2006	Current ECHA Candidate List: JAN 2025 (247) Candidate List Declared Against: JAN 2025 (247) Does not contain REACH SVHC
Halogen Content	Low Halogen - Br, Cl, F, I < 900 ppm per homogenous material. Also BFR/CFR/PVC Free
Solder Process Capability	Not applicable for solder process capability

Product Compliance Disclaimer

This information is provided based on reasonable inquiry of our suppliers and represents our current actual knowledge based on the information they provided. This information is subject to change. The part numbers that TE has identified as EU RoHS compliant have a maximum concentration of 0.1% by weight in homogenous materials for lead, hexavalent chromium, mercury, PBB, PBDE, DBP, BBP, DEHP, DIBP, and 0.01% for cadmium, or qualify for an exemption to these limits as defined in the Annexes of Directive 2011/65/EU (RoHS2). Finished electrical and electronic equipment products will be CE marked as required by Directive 2011/65/EU. Components may not be CE marked. Additionally, the part numbers that TE has identified as EU ELV compliant have a maximum concentration of 0.1% by weight in homogenous materials for lead, hexavalent chromium, and mercury, and 0.01% for cadmium, or qualify for an exemption to these limits as defined in the Annexes of Directive 2000/53/EC (ELV). Regarding the REACH Regulation, the information TE provides on SVHC in articles for this part number is based on the latest European Chemicals Agency (ECHA) 'Guidance on requirements for substances in articles' posted at this URL: <https://echa.europa.eu/guidance-documents/guidance-on-reach>

Compatible Parts



Also in the Series | FASTIN-FASTON 250

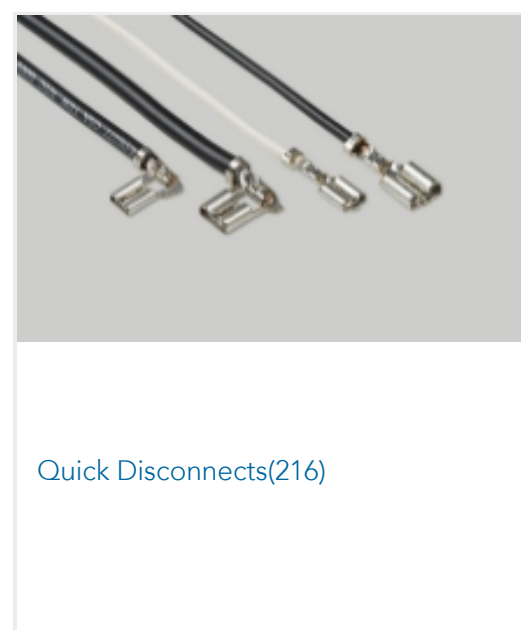
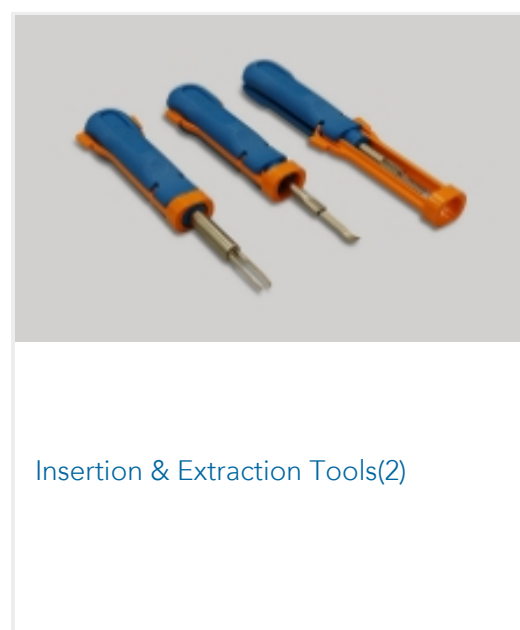
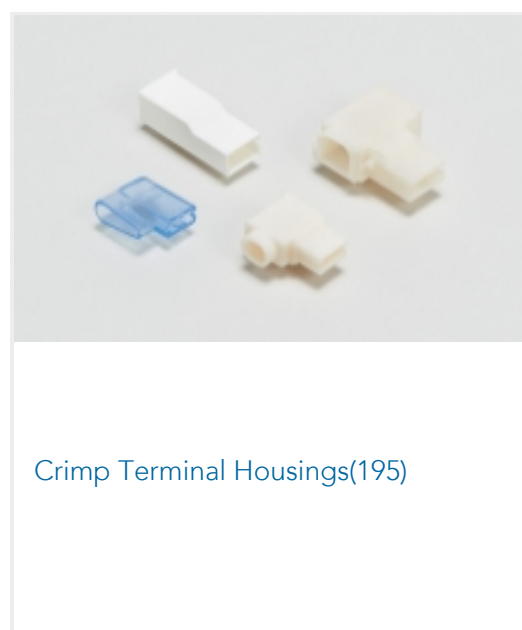

Customers Also Bought



TE Part #AEC16-40SAE-E019
PLG, 40P, BLK, E, XCAP, A

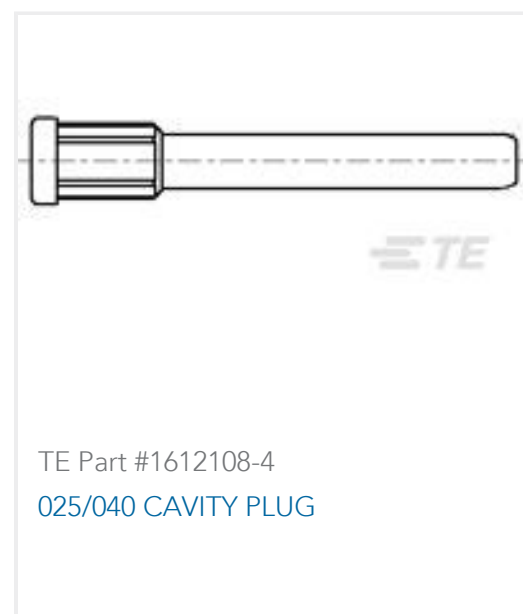

TE Part #1612108-4
025/040 CAVITY PLUG



TE Part #919829-000
SGRP-3



TE Part #EK5194-000
ES2000-NO.6-H2-0-39MM



TE Part #2-34112-2
SOLIS R 22-16COMM 22-18MIL 10



TE Part #HDP26-24-21PE
PLG, 21P, BLK, E, 12/16, P

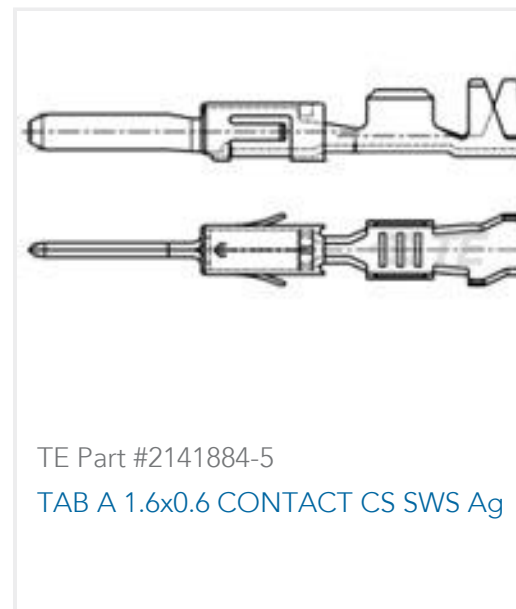

TE Part #2141884-5
TAB A 1.6x0.6 CONTACT CS SWS Ag



TE Part #DT04-12PA-LE20
REC, 12P, BLK, E, CAP, FLANGE, A

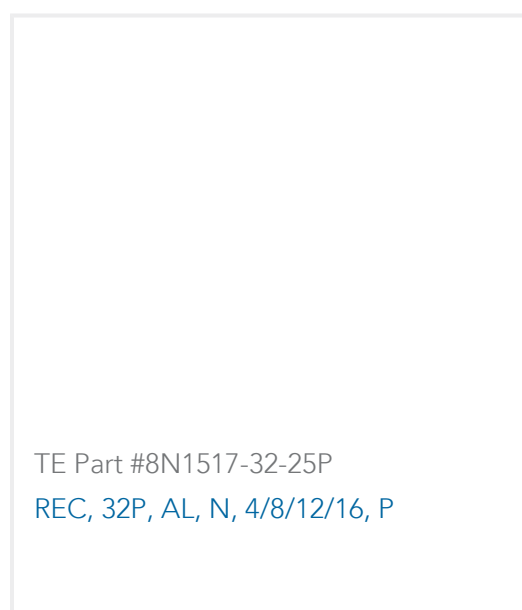

TE Part #8N1517-32-25P
REC, 32P, AL, N, 4/8/12/16, P

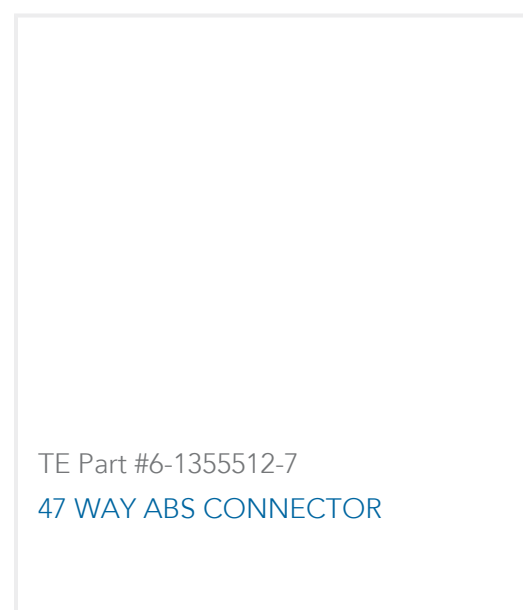

TE Part #6-1355512-7
47 WAY ABS CONNECTOR

Documents

Product Drawings

[FF 250 REC HSG 2P NYLON BLACK](#)

English

CAD Files

[3D PDF](#)

3D

Customer View Model

[ENG_CVM_CVM_480115-3_AR.2d_dxf.zip](#)

English

Customer View Model

[ENG_CVM_CVM_480115-3_AR.3d_igs.zip](#)

English

Customer View Model

[ENG_CVM_CVM_480115-3_AR.3d_stp.zip](#)

English

By downloading the CAD file I accept and agree to the [Terms and Conditions](#) of use.

Datasheets & Catalog Pages



[FASTIN_FASTON_Product_Line](#)

English

[White Paper: Nylon Discoloration](#)

English

[Product Specifications](#)

[Application Specification](#)

English