

34107 ✓ ACTIVE

SOLISTRAND

TE Internal #: 34107

Closed Ring Tongue Terminal, 22 – 16 AWG, M3.5 Stud, 3.68 mm [.145 in] Stud Diameter, Closed Barrel, Straight, Tin Plating, Uninsulated

[View on TE.com >](#)



Terminals & Splices > Ring Terminals

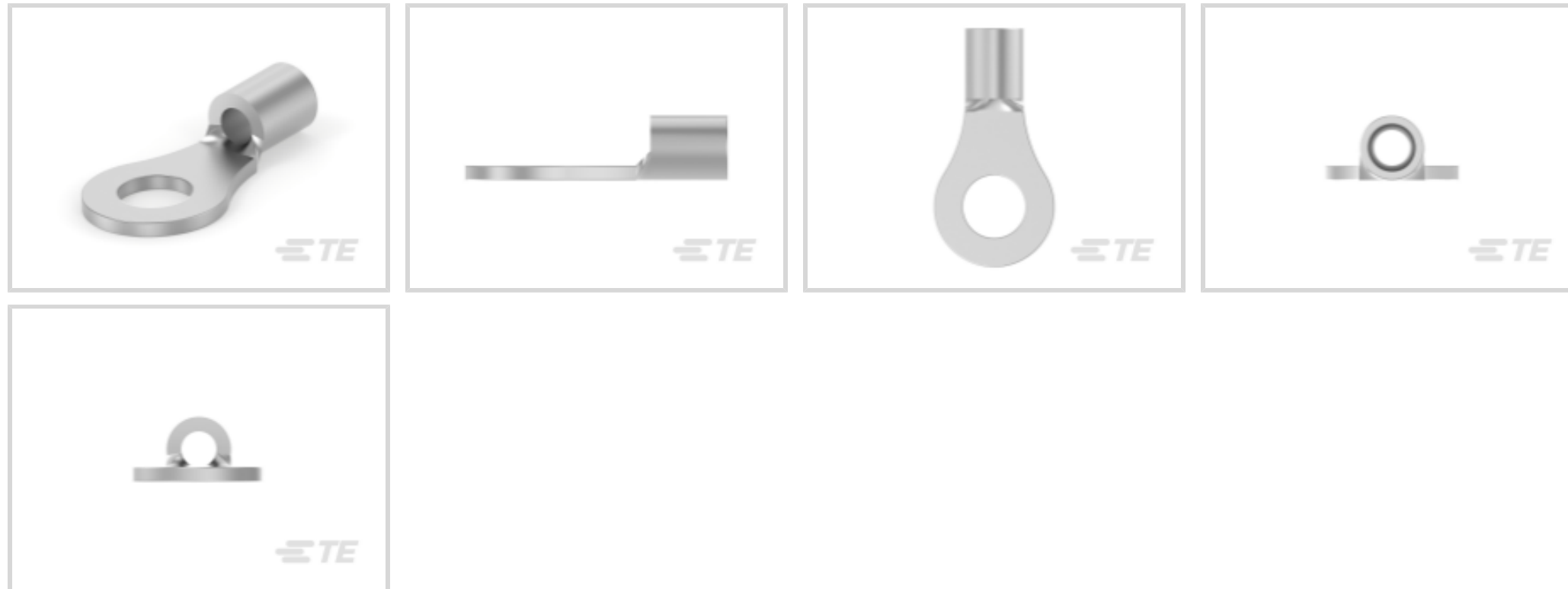

Ring Terminal Product Type: Closed Ring Tongue Terminal

Wire Size: 509 – 3260 CMA

Stud Size: M3.5

Features

Product Type Features

Ring Terminal Product Type	Closed Ring Tongue Terminal
Stud Size	M3.5
Sealable	No
Wire Insulation Support Retention Type	Non-Insulation Support

Configuration Features

Number of Holes	1
-----------------	---

Contact Features

Barrel Type	Closed
Terminal Orientation	Straight
Terminal Plating Material	Tin

Mechanical Attachment

Wire Insulation Support	Without
-------------------------	---------

Dimensions

Wire Size	509 – 3260 CMA
Stud Diameter	3.68 mm [.145 in]



Tongue Thickness	.79 mm[.031 in]
Product Length	14.58 mm[.574 in]
Barrel Inside Diameter	1.55 mm[.061 in]

Usage Conditions

Insulation Option	Uninsulated
-------------------	-------------

Operation/Application

Compatible With Wire Base Material	Copper
Compatible With Wire Plating Material	Tin

Industry Standards

Government Qualified Terminal	No
-------------------------------	----

Packaging Features

Packaging Quantity	1000
Packaging Method	Loose Piece

Product Compliance

[For compliance documentation, visit the product page on TE.com>](#)

EU RoHS Directive 2011/65/EU	Compliant
EU ELV Directive 2000/53/EC	Compliant
China RoHS 2 Directive MIIT Order No 32, 2016	No Restricted Materials Above Threshold
EU REACH Regulation (EC) No. 1907/2006	Current ECHA Candidate List: JAN 2025 (247) Candidate List Declared Against: JUNE 2024 (241) Does not contain REACH SVHC
Halogen Content	Low Halogen - Br, Cl, F, I < 900 ppm per homogenous material. Also BFR/CFR/PVC Free
Solder Process Capability	Not applicable for solder process capability

Product Compliance Disclaimer

This information is provided based on reasonable inquiry of our suppliers and represents our current actual knowledge based on the information they provided. This information is subject to change. The part numbers that TE has identified as EU RoHS compliant have a maximum concentration of 0.1% by weight in homogenous materials for lead, hexavalent chromium, mercury, PBB, PBDE, DBP, BBP, DEHP, DIBP, and 0.01% for cadmium, or qualify for an exemption to these limits as defined in the Annexes of Directive 2011/65/EU (RoHS2). Finished electrical and electronic equipment products will be CE marked as required by Directive 2011/65/EU. Components may not be CE marked. Additionally, the part numbers that TE has identified as EU ELV compliant have a maximum concentration of 0.1% by weight in homogenous materials for lead, hexavalent chromium, and mercury, and 0.01% for cadmium, or qualify for an exemption to these limits as defined in the Annexes of Directive 2000/53/EC (ELV). Regarding the REACH Regulation, the information TE provides on SVHC in articles for this part number is based on the latest European Chemicals Agency (ECHA) 'Guidance on

requirements for substances in articles' posted at this URL: <https://echa.europa.eu/guidance-documents/guidance-on-reach>

Compatible Parts

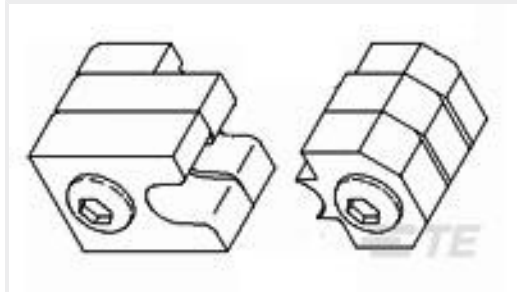

TE Part # 47812
DIES SOLIS 22-16 DIE SET



TE Part # 49935
DAHT SOLIS 22-10 ASSY



TE Part # 525693
DAHT SOLIS 22-10 ASSY



TE Part # 58545-3
SDE DIE ASSY. 22-10 SOLISTRAND



TE Part # 58545-1
SOLISTRAND 10-22 DIE ASSY



TE Part # 58546-1
PC 22-10 SOLISPICE SPL I SHT



TE Part # 169400
CERTI-LOK FRAME W/O DIES

Customers Also Bought

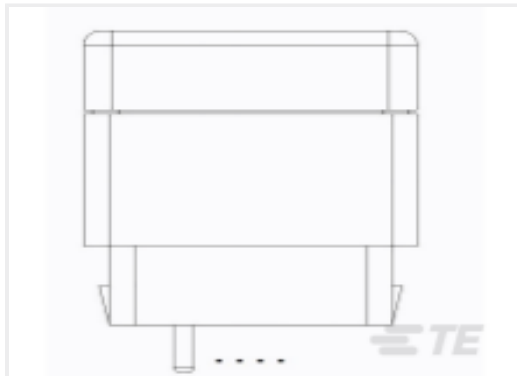

TE Part #65002-06N
RECP ASSY



TE Part #52947
PG SP SPD 22-16COMM 22-18MIL 4

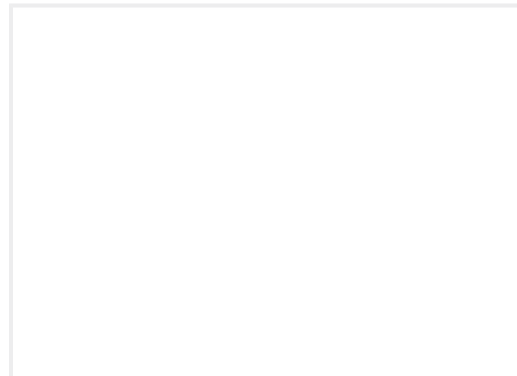

TE Part #GAG2K3499B1
Radial Glass NTC 2K 1% B3499 1.5mm OD

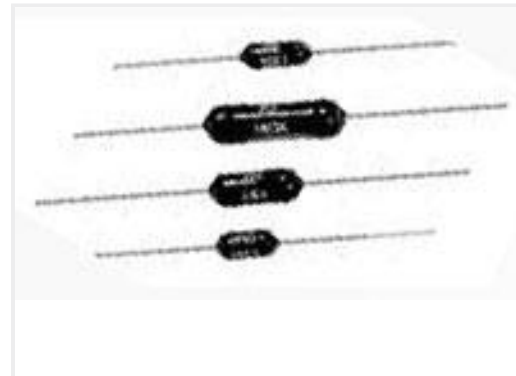

TE Part #3-1879642-7
H8 2K5 0.1% 25PPM

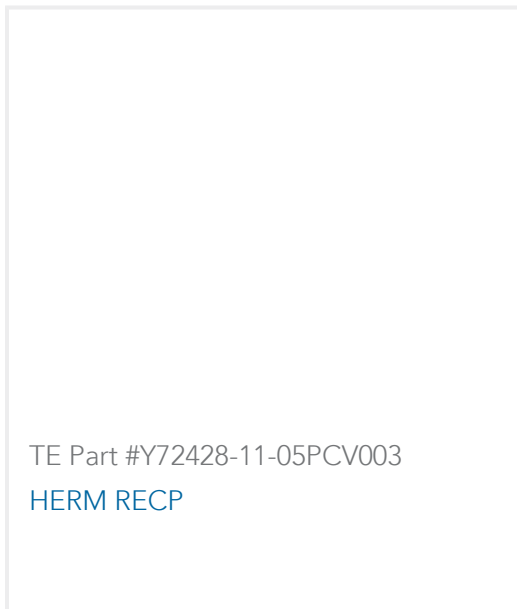

TE Part #Y72428-11-05PCV003
HERM RECP

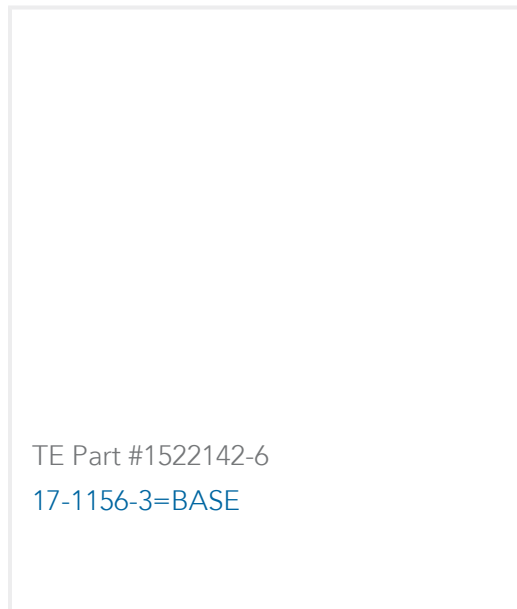

TE Part #1522142-6
17-1156-3=BASE

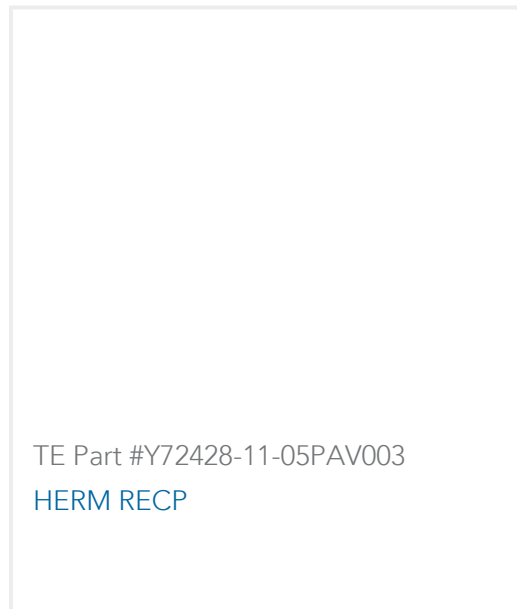

TE Part #Y72428-11-05PAV003
HERM RECP

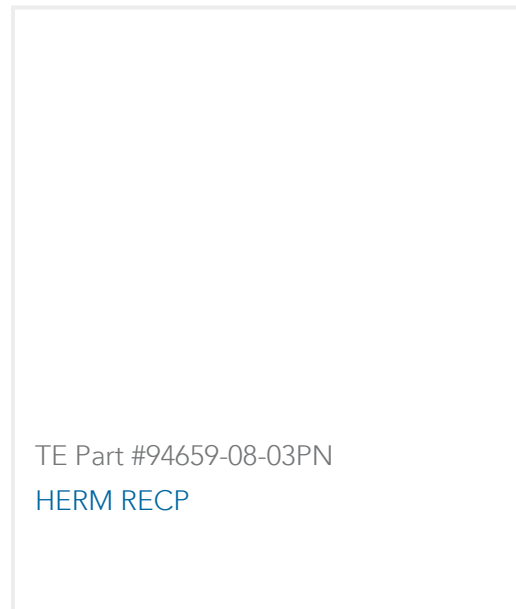

TE Part #94659-08-03PN
HERM RECP

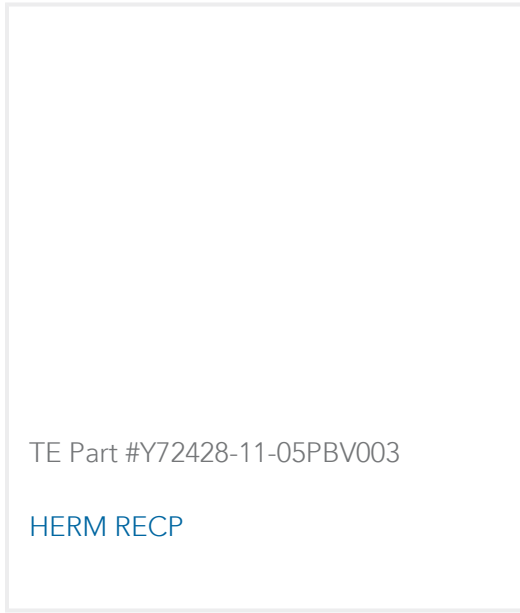

Documents

Product Drawings

[SOLIS R 22-16 COMM 22-18 MIL 6](#)

English

CAD Files

Customer View Model

[ENG_CVM_CVM_34107_Y.2d_dxf.zip](#)

English

3D PDF

3D

Customer View Model

[ENG_CVM_CVM_34107_Y.3d_igs.zip](#)

English

Customer View Model

[ENG_CVM_CVM_34107_Y.3d_stp.zip](#)

English

By downloading the CAD file I accept and agree to the [Terms and Conditions](#) of use.

Datasheets & Catalog Pages

[SOLISTRAND - QRG](#)

English

Instruction Sheets

[Instruction Sheet \(U.S.\)](#)

English

Agency Approvals

[UL](#)

English