

320665 ✓ ACTIVE

PLASTI-GRIP

TE Internal #: 320665

Spade Tongue Terminal, 22 – 16 AWG, #6 / M3.5 Stud, 3.68 mm [.145 in] Stud Diameter, Closed Barrel, Straight, Tin Plating, PLASTI-GRIP

[View on TE.com >](#)



Terminals & Splices > Spade Terminals

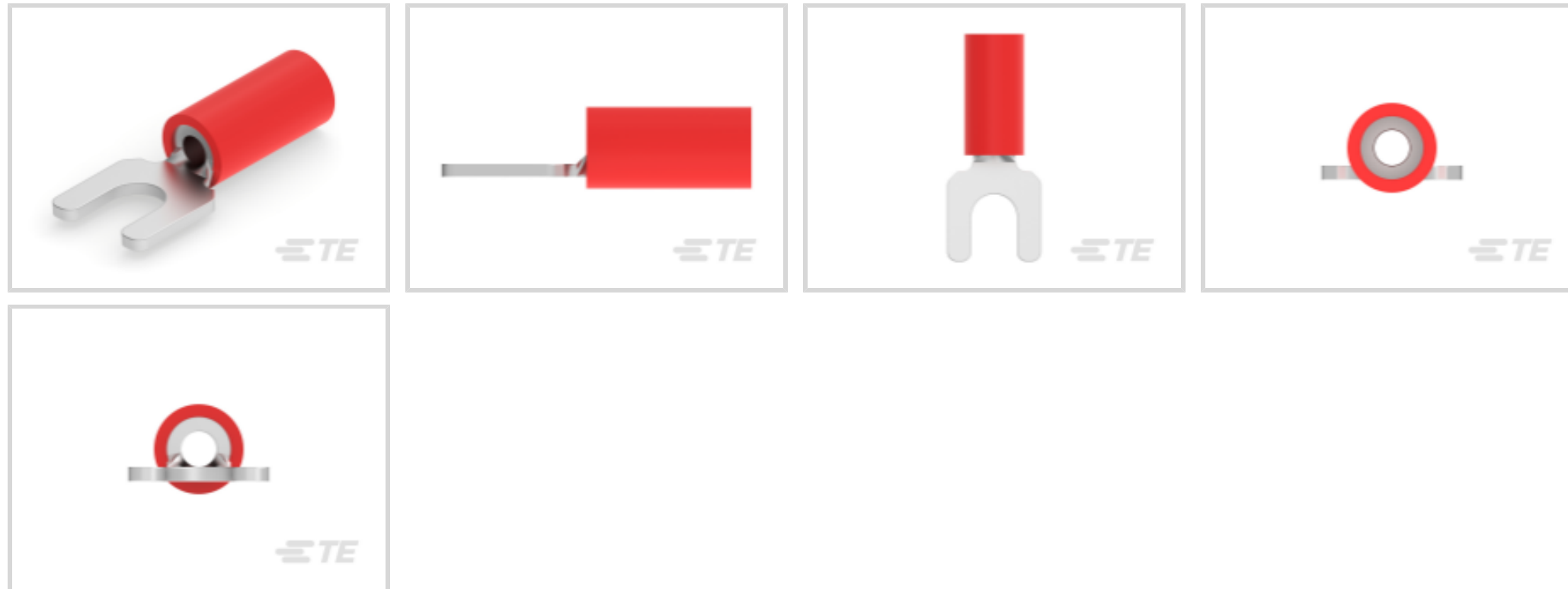

Spade Terminal Type: **Spade Tongue Terminal**

Wire Size: **509 – 3260 CMA**

Stud Size: **#6, M3.5**

Features

Product Type Features

Stud Size	#6, M3.5
Sealable	No
Wire Insulation Support Retention Type	Non-Insulation Support

Electrical Characteristics

Voltage Rating	600 V
----------------	-------

Body Features

Product Weight	3.344 g
----------------	---------

Contact Features

Spade Terminal Type	Spade Tongue Terminal
Barrel Type	Closed
Terminal Orientation	Straight
Terminal Plating Material	Tin

Mechanical Attachment

Wire Insulation Support	With
-------------------------	------

Dimensions



Wire Size	509 – 3260 CMA
Stud Diameter	3.68 mm [.145 in]
Tongue Thickness	.79 mm [.031 in]
Product Length	19.43 mm [.765 in]
Compatible Insulation Diameter (Max)	3.56 mm [.14 in]
Compatible Insulation Diameter Range	2.67 – 3.56 mm [.105 – .14 in]

Usage Conditions

Insulation Option	Partially Insulated
-------------------	---------------------

Operation/Application

Compatible With Wire Base Material	Copper
Compatible With Wire Plating Material	Tin

Industry Standards

Government Qualified Terminal	No
-------------------------------	----

Packaging Features

Packaging Quantity	1000
Packaging Method	Loose Piece

Product Compliance

[For compliance documentation, visit the product page on TE.com>](#)

EU RoHS Directive 2011/65/EU	Compliant
EU ELV Directive 2000/53/EC	Compliant
China RoHS 2 Directive MIIT Order No 32, 2016	No Restricted Materials Above Threshold
EU REACH Regulation (EC) No. 1907/2006	Current ECHA Candidate List: JAN 2025 (247) Candidate List Declared Against: JAN 2025 (247) Does not contain REACH SVHC
Halogen Content	Not Low Halogen - contains Br or Cl > 900 ppm.
Solder Process Capability	Not applicable for solder process capability

Product Compliance Disclaimer

This information is provided based on reasonable inquiry of our suppliers and represents our current actual knowledge based on the information they provided. This information is subject to change. The part numbers that TE has identified as EU RoHS compliant have a maximum concentration of 0.1% by weight in homogenous materials for lead, hexavalent chromium, mercury, PBB, PBDE, DBP, BBP, DEHP, DIBP, and 0.01% for cadmium, or qualify for an exemption to these limits as defined in the Annexes of Directive 2011/65/EU (RoHS2). Finished electrical and electronic equipment products

will be CE marked as required by Directive 2011/65/EU. Components may not be CE marked. Additionally, the part numbers that TE has identified as EU ELV compliant have a maximum concentration of 0.1% by weight in homogenous materials for lead, hexavalent chromium, and mercury, and 0.01% for cadmium, or qualify for an exemption to these limits as defined in the Annexes of Directive 2000/53/EC (ELV). Regarding the REACH Regulation, the information TE provides on SVHC in articles for this part number is based on the latest European Chemicals Agency (ECHA) 'Guidance on requirements for substances in articles' posted at this URL: <https://echa.europa.eu/guidance-documents/guidance-on-reach>

Compatible Parts

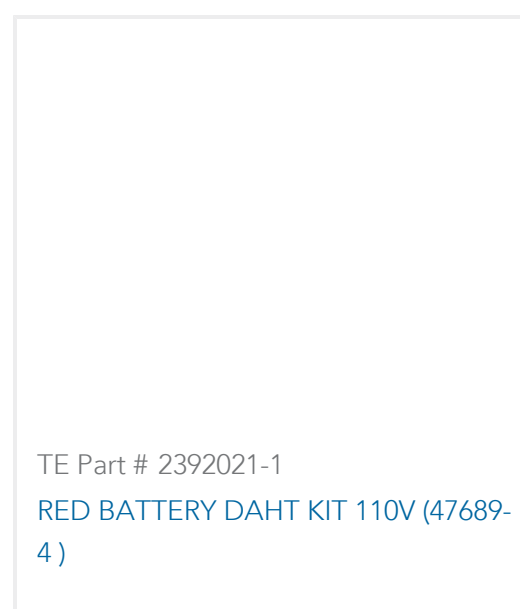
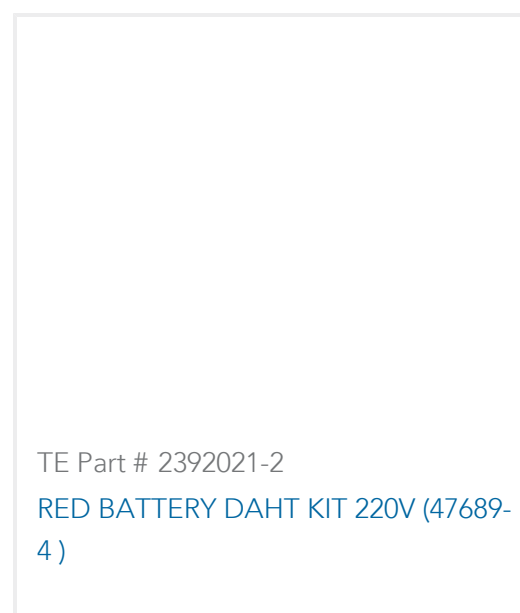

Also in the Series | **PLASTI-GRIP**



Compression Connectors(3)

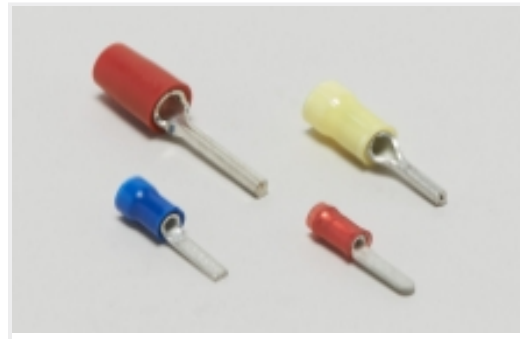

Crimp Wire Pins, Tabs & Ferrules(20)



Ring Terminals(310)

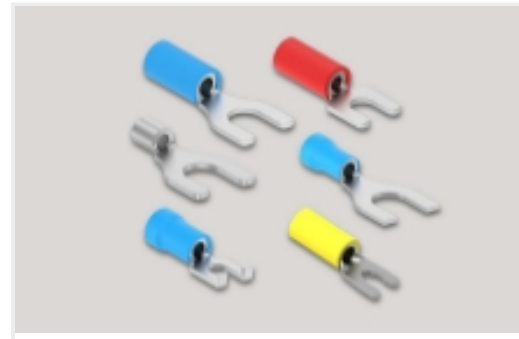

Spade Terminals(158)



Splices(45)

Customers Also Bought

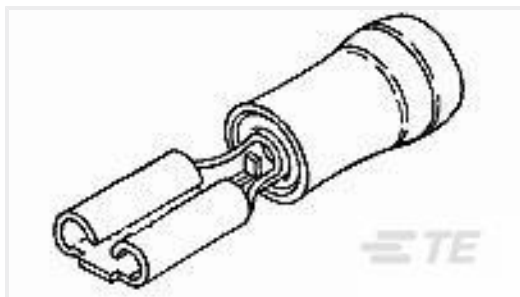

TE Part #165619-2
110 PIDG FASTON REC



TE Part #1-6609006-3
10EEJ1=F8017 S0



TE Part #34167
TERMINAL,PG SPD 16-14 10

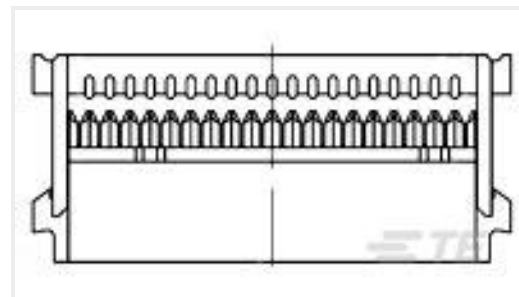

TE Part #1-1658526-2
609-2030LF FEM SOCKET,LEAD FREE



TE Part #1775441-2
EMIX CONN., 1.5MM PITCH, RCPT, HSG, 2P



TE Part #2106136-2
Assembly, Receptacle, 2-Position



TE Part #212609-1
RECEPT HSG,4 POSN,METRIMATE

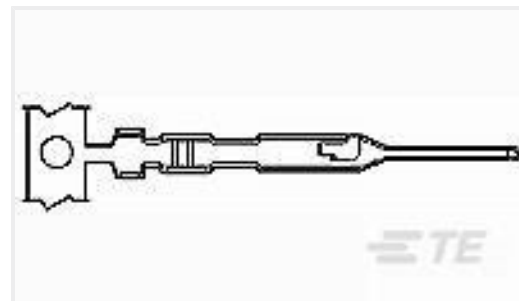

TE Part #104505-3
MTE PIN LP

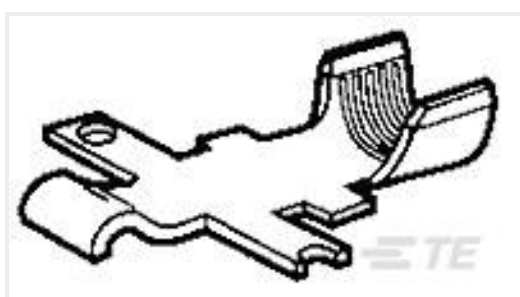

TE Part #53880-4
CONTACT,PWR LK,SRS2,LS PC,CRMP

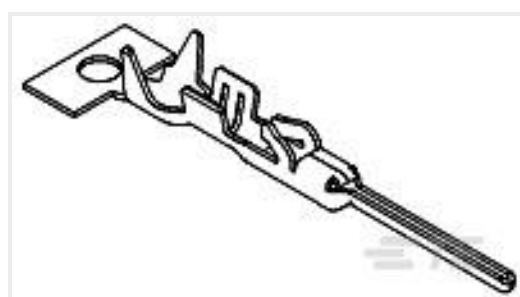

TE Part #2-2106124-7
Contact, Tab, Tin Plated, LP 22-16 AWG

Documents



Product Drawings

[PG SPD 22-16 COMM 22-18 MIL 6](#)

English

CAD Files

Customer View Model

[ENG_CVM_CVM_320665_N.2d_dxf.zip](#)

English

3D PDF

3D

Customer View Model

[ENG_CVM_CVM_320665_N.3d_igs.zip](#)

English

Customer View Model

[ENG_CVM_CVM_320665_N.3d_stp.zip](#)

English

By downloading the CAD file I accept and agree to the [Terms and Conditions](#) of use.

Product Specifications

[Application Specification](#)

English

Agency Approvals

[UL](#)

English