



Connectors > Lighting Connectors > Plug & Socket Lighting Connectors



Connector System: **Cable-to-Cable**

Number of Positions: **2**

Sealable: **No**

Connector & Contact Terminates To: **Wire & Cable**

Lighting Connector Style: **Splitter**

### Features

#### Product Type Features

Connector System	Cable-to-Cable
Sealable	No
Connector & Contact Terminates To	Wire & Cable
Lighting Connector Style	Splitter
Connector Product Type	Connector Assembly

#### Configuration Features

Keying Arrangement	LV-2/LV-2 & LV-2
Number of Positions	2

#### Electrical Characteristics

Operating Voltage	42 VDC
-------------------	--------

#### Body Features

Primary Product Color	Yellow
-----------------------	--------

#### Contact Features

--	--



Contact Type	Pin, Socket
--------------	-------------

### Mechanical Attachment

Connector Mounting Type	Cable Mount (Free-Hanging)
-------------------------	----------------------------

### Operation/Application

Circuit Application	Power
---------------------	-------

### Industry Standards

Compatible With Agency/Standards Products	VDE
---	-----

### Packaging Features

Packaging Method	Bag
------------------	-----

## Product Compliance

[For compliance documentation, visit the product page on TE.com>](#)

EU RoHS Directive 2011/65/EU	Compliant
EU ELV Directive 2000/53/EC	Compliant
China RoHS 2 Directive MIIT Order No 32, 2016	No Restricted Materials Above Threshold
EU REACH Regulation (EC) No. 1907/2006	Current ECHA Candidate List: JAN 2025 (247) Candidate List Declared Against: JAN 2025 (247) Does not contain REACH SVHC
Halogen Content	Not Low Halogen - contains Br or Cl > 900 ppm.
Solder Process Capability	Not applicable for solder process capability

#### Product Compliance Disclaimer

This information is provided based on reasonable inquiry of our suppliers and represents our current actual knowledge based on the information they provided. This information is subject to change. The part numbers that TE has identified as EU RoHS compliant have a maximum concentration of 0.1% by weight in homogenous materials for lead, hexavalent chromium, mercury, PBB, PBDE, DBP, BBP, DEHP, DIBP, and 0.01% for cadmium, or qualify for an exemption to these limits as defined in the Annexes of Directive 2011/65/EU (RoHS2). Finished electrical and electronic equipment products will be CE marked as required by Directive 2011/65/EU. Components may not be CE marked. Additionally, the part numbers that TE has identified as EU ELV compliant have a maximum concentration of 0.1% by weight in homogenous materials for lead, hexavalent chromium, and mercury, and 0.01% for cadmium, or qualify for an exemption to these limits as defined in the Annexes of Directive 2000/53/EC (ELV). Regarding the REACH Regulation, the information TE provides on SVHC in articles for this part number is based on the latest European Chemicals Agency (ECHA) 'Guidance on requirements for substances in articles' posted at this URL: <https://echa.europa.eu/guidance-documents/guidance-on-reach>

## Compatible Parts



### Also in the Series | NECTOR S

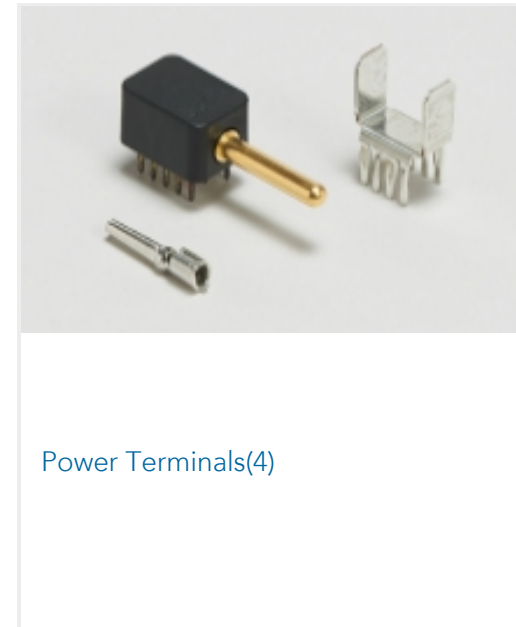
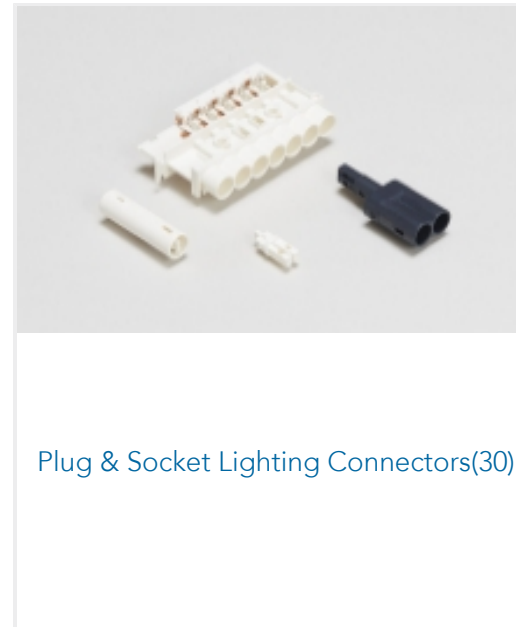
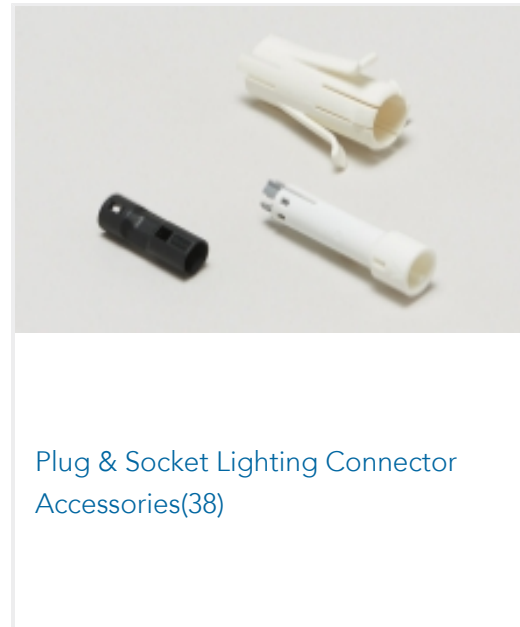
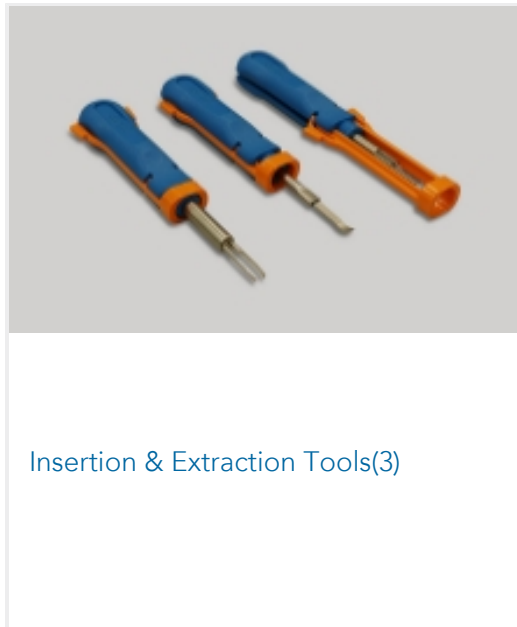

### Customers Also Bought

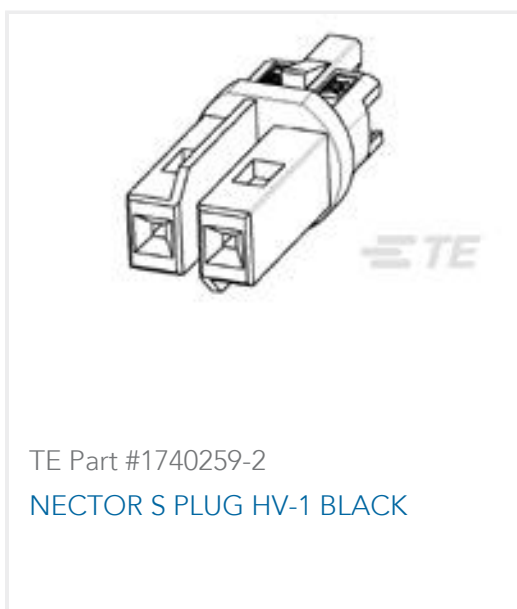
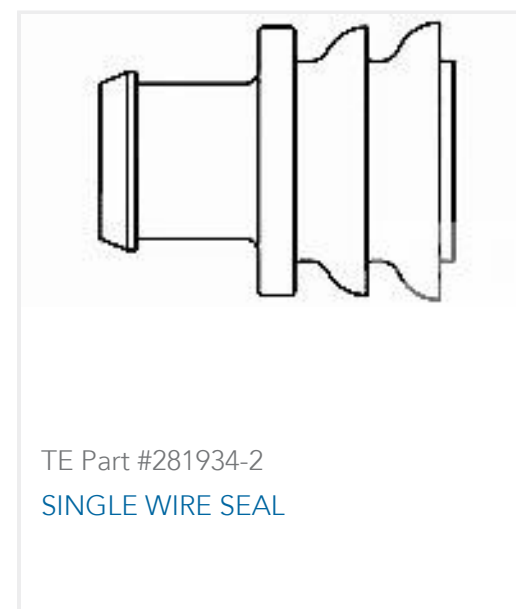
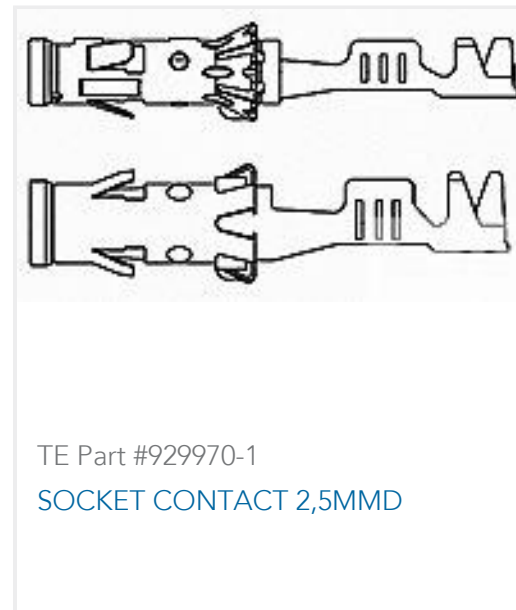



## Documents

### Product Drawings

#### NECTOR S T SPLITTER LV-2

English

---

### CAD Files

#### Customer View Model

[ENG\\_CVM\\_CVM\\_293234-8\\_C.2d\\_dxf.zip](#)

English

#### 3D PDF

3D

#### Customer View Model

[ENG\\_CVM\\_CVM\\_293234-8\\_C.3d\\_igs.zip](#)

English

#### Customer View Model

[ENG\\_CVM\\_CVM\\_293234-8\\_C.3d\\_stp.zip](#)

English

By downloading the CAD file I accept and agree to the [Terms and Conditions](#) of use.

---

### Datasheets & Catalog Pages

#### NECTOR\_S\_LINE\_CONNECTOR\_BROCHURE

English

---

### Product Specifications

#### Product Specification

English