



PIDG

TE Internal #: 2-32561-1

Spade Flange Tongue Terminal, 22 AWG, #6 / M3.5 Stud, 3.68 mm [.145 in] Stud Diameter, Closed Barrel, Flanged, Tin Plating, Partially Insulated, PIDG

[View on TE.com >](#)

Terminals & Splices > Spade Terminals > PIDG Flanged Spade Tongue Terminals

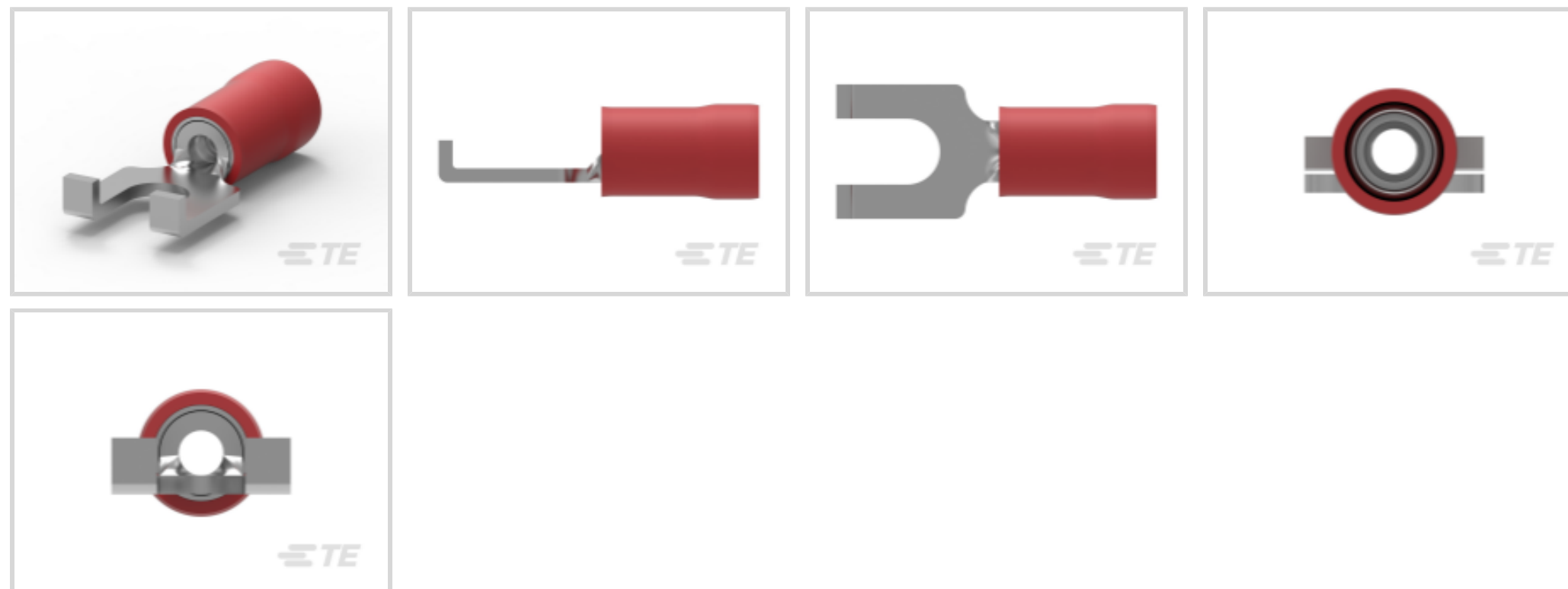

Spade Terminal Type: **Spade Flange Tongue Terminal**

Wire Size: **509 – 3260 CMA**

Stud Size: **#6, M3.5**

[All PIDG Flanged Spade Tongue Terminals \(51\)](#)

Features

Product Type Features

Stud Size	#6, M3.5
Sealable	No
Wire Insulation Support Retention Type	Insulation Support

Electrical Characteristics

Voltage Rating	300 V
----------------	-------

Body Features

Product Weight	.764 g
Insulation Sleeve Color	Red
Stripe Color	Red

Contact Features

Spade Terminal Type	Spade Flange Tongue Terminal
Barrel Type	Closed
Terminal Orientation	Flanged
Terminal Plating Material	Tin



Mechanical Attachment

Wire Insulation Support	With
-------------------------	------

Dimensions

Wire Size	509 – 3260 CMA
Stud Diameter	3.68 mm [.145 in]
Tongue Thickness	.79 mm [.031 in]
Product Length	18.71 mm [.737 in]
Compatible Insulation Diameter (Max)	3.18 mm [.125 in]
Compatible Insulation Diameter Range	2.03 – 3.18 mm [.08 – .125 in]

Usage Conditions

Insulation Option	Partially Insulated
-------------------	---------------------

Operation/Application

Compatible With Wire Base Material	Copper
Compatible With Wire Plating Material	Tin

Industry Standards

Government Qualified Terminal	No
-------------------------------	----

Packaging Features

Packaging Quantity	5000
Packaging Method	Tape Mounted

Product Compliance

[For compliance documentation, visit the product page on TE.com>](#)

EU RoHS Directive 2011/65/EU	Compliant
EU ELV Directive 2000/53/EC	Compliant
China RoHS 2 Directive MIIT Order No 32, 2016	No Restricted Materials Above Threshold
EU REACH Regulation (EC) No. 1907/2006	Current ECHA Candidate List: JAN 2025 (247) Candidate List Declared Against: JAN 2025 (247) Does not contain REACH SVHC
Halogen Content	Low Halogen - Br, Cl, F, I < 900 ppm per homogenous material. Also BFR/CFR/PVC Free
Solder Process Capability	Not applicable for solder process capability

Product Compliance Disclaimer

This information is provided based on reasonable inquiry of our suppliers and represents our current actual knowledge based on the information they provided. This information is subject to change. The part numbers that TE has identified as EU RoHS compliant have a maximum concentration of 0.1% by weight in homogenous materials for lead, hexavalent chromium, mercury, PBB, PBDE, DBP, BBP, DEHP, DIBP, and 0.01% for cadmium, or qualify for an exemption to these limits as defined in the Annexes of Directive 2011/65/EU (RoHS2). Finished electrical and electronic equipment products will be CE marked as required by Directive 2011/65/EU. Components may not be CE marked. Additionally, the part numbers that TE has identified as EU ELV compliant have a maximum concentration of 0.1% by weight in homogenous materials for lead, hexavalent chromium, and mercury, and 0.01% for cadmium, or qualify for an exemption to these limits as defined in the Annexes of Directive 2000/53/EC (ELV). Regarding the REACH Regulation, the information TE provides on SVHC in articles for this part number is based on the latest European Chemicals Agency (ECHA) 'Guidance on requirements for substances in articles' posted at this URL: <https://echa.europa.eu/guidance-documents/guidance-on-reach>

Compatible Parts



TE Part # 58423-1
DIE, RBY IS9252



TE Part # 47386
DAHT PG PIDG 26-16 ASSY



TE Part # 58433-3
PRO CR ASSY, RBY IS9252



TE Part # 169404
CERTI-LOK DIE

Also in the Series | PIDG



Compression Connectors(17)



Crimp Wire Pins, Tabs & Ferrules(41)



Hand Crimping Tools(2)



Knife Disconnects(11)



Ring Terminals(588)

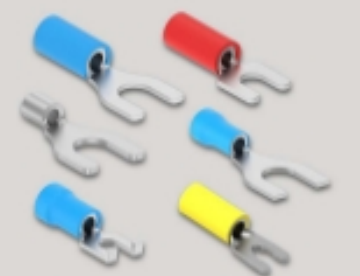

Spade Terminals(228)



Special Purpose Terminals(1)



Splices(41)

Customers Also Bought

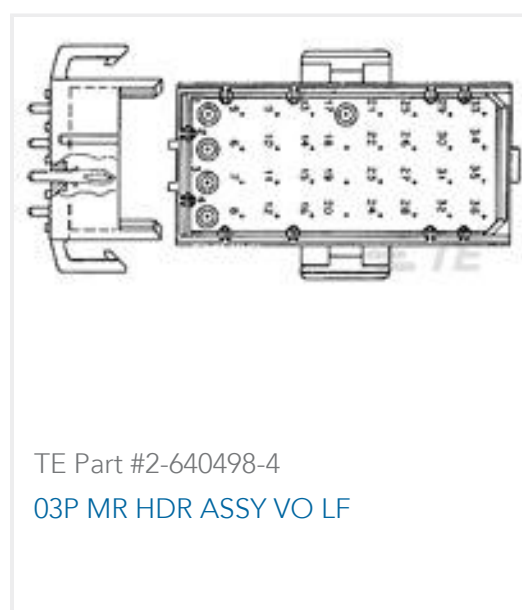
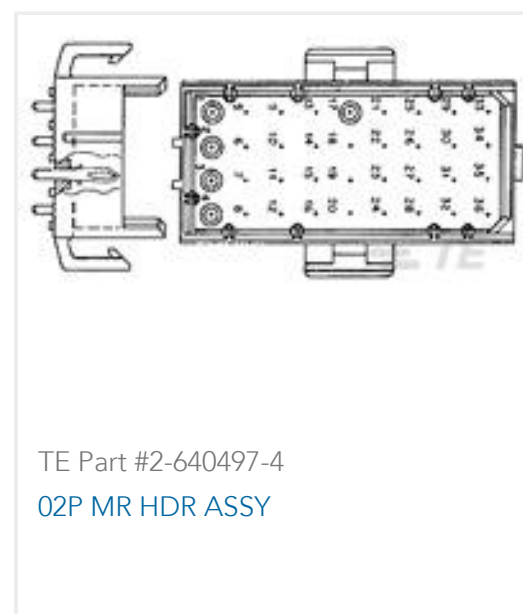

Documents

Product Drawings

[PIDG SPDFLG 22-16COMM22-18MIL6](#)

English

CAD Files

[3D PDF](#)

English

Customer View Model

[ENG_CVM_2-32561-1_L.2d_dxf.zip](#)

English

Customer View Model

[ENG_CVM_2-32561-1_L.3d_igs.zip](#)

English

Customer View Model

[ENG_CVM_2-32561-1_L.3d_stp.zip](#)

English

By downloading the CAD file I accept and agree to the [Terms and Conditions](#) of use.

Instruction Sheets



[Instruction Sheet \(U.S.\)](#)

English

[Agency Approvals](#)

[UL Report](#)

English