



## Product Compliance

[For compliance documentation, visit the product page on TE.com>](#)

EU RoHS Directive 2011/65/EU	Compliant
EU ELV Directive 2000/53/EC	Compliant
China RoHS 2 Directive MIIT Order No 32, 2016	No Restricted Materials Above Threshold
EU REACH Regulation (EC) No. 1907/2006	Current ECHA Candidate List: JAN 2025 (247) Candidate List Declared Against: JAN 2021 (211) Does not contain REACH SVHC
Halogen Content	BFR/CFR/PVC Free, but Br/Cl >900 ppm in other sources.
Solder Process Capability	Reflow solder capable to 245°C

### Product Compliance Disclaimer

This information is provided based on reasonable inquiry of our suppliers and represents our current actual knowledge based on the information they provided. This information is subject to change. The part numbers that TE has identified as EU RoHS compliant have a maximum concentration of 0.1% by weight in homogenous materials for lead, hexavalent chromium, mercury, PBB, PBDE, DBP, BBP, DEHP, DIBP, and 0.01% for cadmium, or qualify for an exemption to these limits as defined in the Annexes of Directive 2011/65/EU (RoHS2). Finished electrical and electronic equipment products will be CE marked as required by Directive 2011/65/EU. Components may not be CE marked. Additionally, the part numbers that TE has identified as EU ELV compliant have a maximum concentration of 0.1% by weight in homogenous materials for lead, hexavalent chromium, and mercury, and 0.01% for cadmium, or qualify for an exemption to these limits as defined in the Annexes of Directive 2000/53/EC (ELV). Regarding the REACH Regulation, the information TE provides on SVHC in articles for this part number is based on the latest European Chemicals Agency (ECHA) 'Guidance on requirements for substances in articles' posted at this URL: <https://echa.europa.eu/guidance-documents/guidance-on-reach>

## Compatible Parts

TE Part # 3-1879387-2 MGDQ5-00004,S-L4.7Imax9.5	TE Part # 3-1879387-3 MGDQ5-00005,S-L10Imax4	TE Part # 6-1879387-0 MGDQ6-00006, S-L4.7 Imax6.8	TE Part # 6-1879387-3 S-L10, Imax5.4, RoHS DQ1280-100M
--	---	--	---

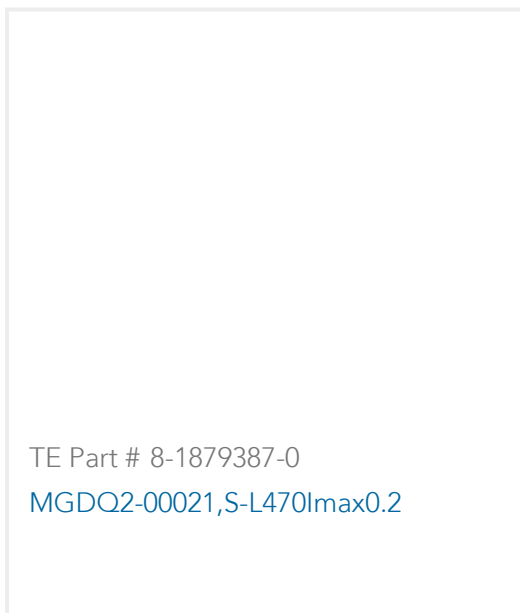

TE Part # 8-1879387-0  
MGDQ2-00021,S-L470Imax0.2

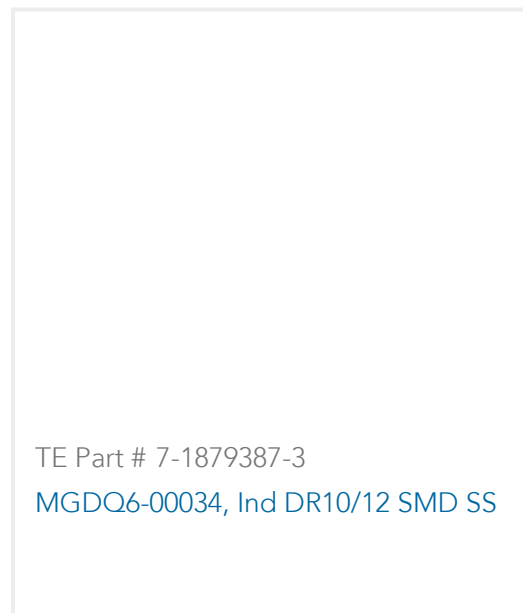

TE Part # 7-1879387-3  
MGDQ6-00034, Ind DR10/12 SMD SS

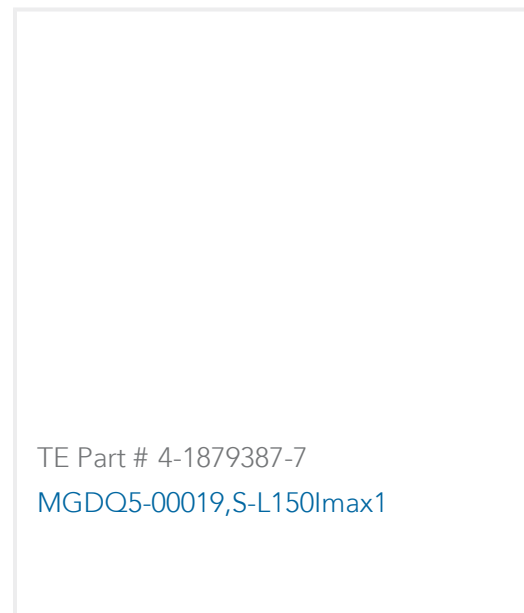

TE Part # 4-1879387-7  
MGDQ5-00019,S-L150Imax1



TE Part # 2-1879387-0  
MGDQ4-00012,S-L47Imax0.88

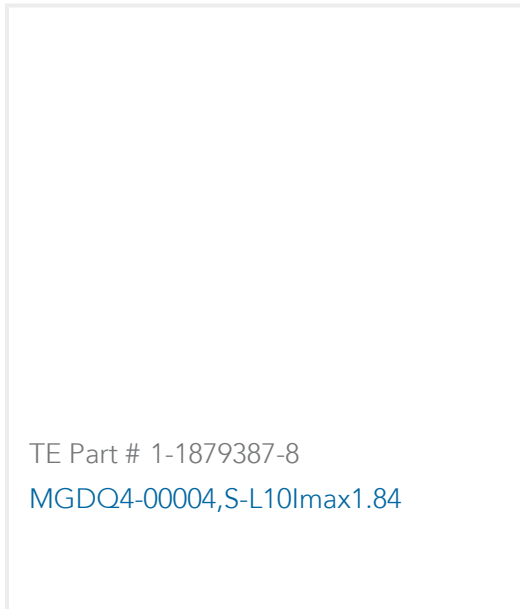

TE Part # 1-1879387-8  
MGDQ4-00004,S-L10Imax1.84

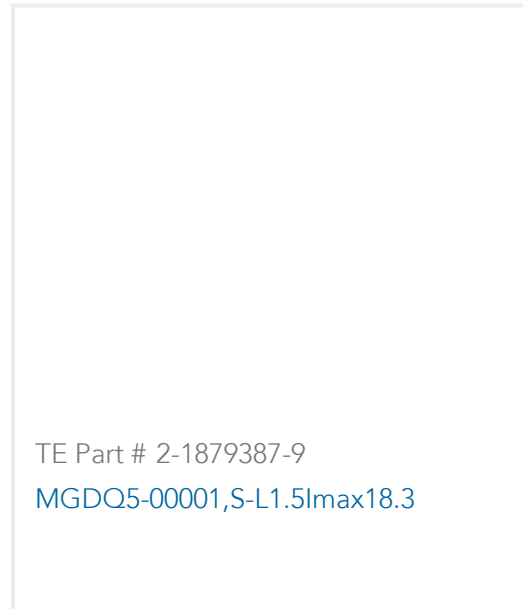

TE Part # 2-1879387-9  
MGDQ5-00001,S-L1.5Imax18.3

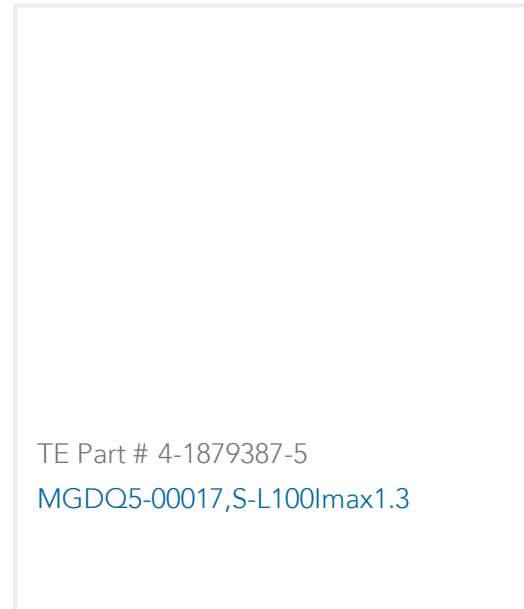

TE Part # 4-1879387-5  
MGDQ5-00017,S-L100Imax1.3

### Customers Also Bought



TE Part #CAT-D48-ST273  
DEUTSCH Solid Contacts



TE Part #206070-8  
CABLE CLAMP KIT #17



TE Part #CAT-D487-W416  
Wedgelocks: DEUTSCH DT



TE Part #DT06-2S  
PLG, 2P, GRY, N



TE Part #DT04-2P  
REC, 2P, GRY, N



TE Part #CAT-AM71-CH8172  
AMP SUPERSEAL 1.5MM,  
CONNECTOR HOUSING

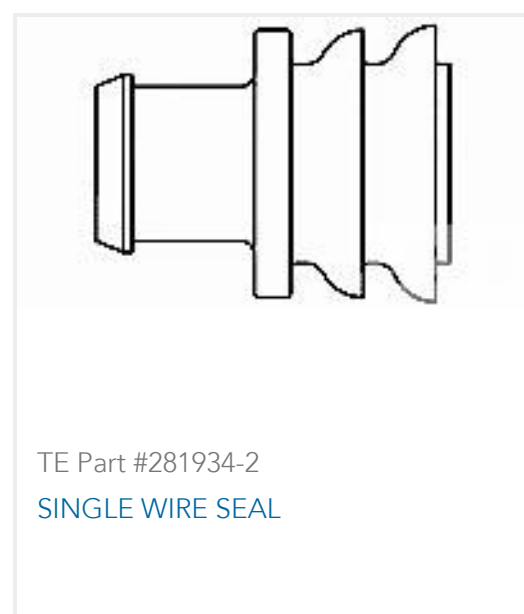

TE Part #281934-2  
SINGLE WIRE SEAL

### Documents

#### Product Drawings

[MGDQ2-00013,S-L100Imax0.42](#)

English

[MGDQ2-00013,S-L100Imax0.42](#)

English

#### Datasheets & Catalog Pages

[1309350\\_PASSIVE\\_COMPONENT](#)

English

