

174353-7 ✓ ACTIVE

Econoseal

TE Internal #: 174353-7

2 Position, Yellow, Double Lock Plate, PBT, -30 – 105 °C [-22 – 221 °

F]

[View on TE.com >](#)



Connectors > Automotive Connectors > Automotive Connector Accessories > Automotive Connector Locks & Position Assurance

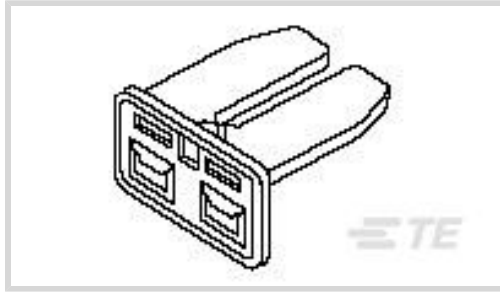

Number of Positions: 2

Primary Product Color: **Yellow**

Connector & Contact Retention Accessory Type: **Double Lock Plate**

Primary Product Material: **PBT**

Operating Temperature Range: **-30 – 105 °C [-22 – 221 °F]**

Features

Product Type Features

Sealable	No
Connector & Contact Retention Accessory Type	Double Lock Plate

Configuration Features

Number of Positions	2
---------------------	---

Body Features

Primary Product Color	Yellow
Primary Product Material	PBT

Usage Conditions

Operating Temperature Range	-30 – 105 °C[-22 – 221 °F]
-----------------------------	----------------------------

Industry Standards

UL Flammability Rating	UL 94V-2
------------------------	----------

Packaging Features

Packaging Method	Bag
Packaging Quantity	1000

Other

Serviceable	Yes
-------------	-----

Product Compliance



[For compliance documentation, visit the product page on TE.com>](#)

EU RoHS Directive 2011/65/EU	Compliant
EU ELV Directive 2000/53/EC	Compliant
China RoHS 2 Directive MIIT Order No 32, 2016	No Restricted Materials Above Threshold
EU REACH Regulation (EC) No. 1907/2006	Current ECHA Candidate List: JAN 2025 (247) Candidate List Declared Against: JAN 2025 (247) Does not contain REACH SVHC
Halogen Content	Not Low Halogen - contains Br or Cl > 900 ppm.
Solder Process Capability	Not applicable for solder process capability

Product Compliance Disclaimer

This information is provided based on reasonable inquiry of our suppliers and represents our current actual knowledge based on the information they provided. This information is subject to change. The part numbers that TE has identified as EU RoHS compliant have a maximum concentration of 0.1% by weight in homogenous materials for lead, hexavalent chromium, mercury, PBB, PBDE, DBP, BBP, DEHP, DIBP, and 0.01% for cadmium, or qualify for an exemption to these limits as defined in the Annexes of Directive 2011/65/EU (RoHS2). Finished electrical and electronic equipment products will be CE marked as required by Directive 2011/65/EU. Components may not be CE marked. Additionally, the part numbers that TE has identified as EU ELV compliant have a maximum concentration of 0.1% by weight in homogenous materials for lead, hexavalent chromium, and mercury, and 0.01% for cadmium, or qualify for an exemption to these limits as defined in the Annexes of Directive 2000/53/EC (ELV). Regarding the REACH Regulation, the information TE provides on SVHC in articles for this part number is based on the latest European Chemicals Agency (ECHA) 'Guidance on requirements for substances in articles' posted at this URL: <https://echa.europa.eu/guidance-documents/guidance-on-reach>

Compatible Parts

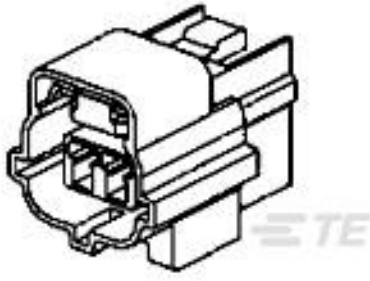

TE Part # 881773-1
KIT ECONOSEAL J I P

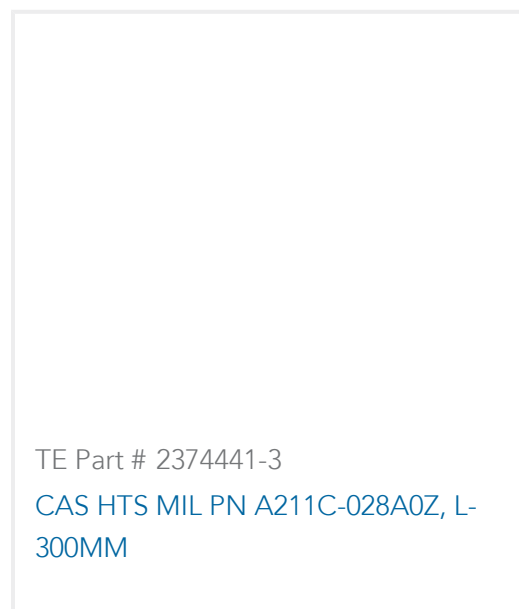

TE Part # 2374441-3
CAS HTS MIL PN A211C-028A0Z, L-300MM



TE Part # CAT-EC7491-CH8172
ECONOSEAL, CONNECTOR HOUSING

Customers Also Bought

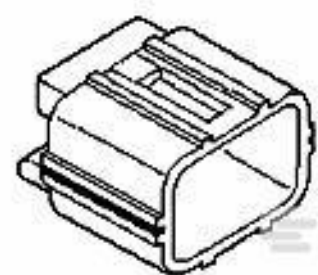

TE Part #174360-7
070 ECONOSEAL MARK-2 P/CAP 3P



TE Part #174983-7
8 POS DL PLATE FOR PLUG MKII+



TE Part #2822346-1
ECONO-J MK-2 PLUG ASSY 6P



TE Part #174263-7
ECONOSEAL-J MK-2 LCOK PLATE 6P

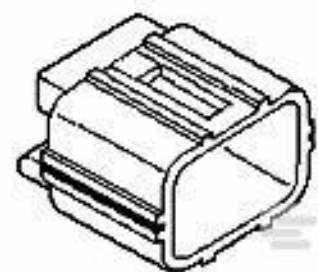

TE Part #174355-7
070 ECONOSEAL MARK-2 P/CAP 2P

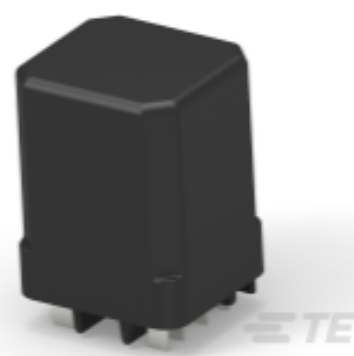

TE Part #4-1393117-6
KUP-11D15-36=KU



TE Part #173707-1
E-J MK-2 070 REC CONT LP

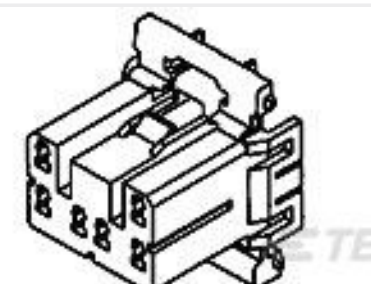

TE Part #174952-5
070 MLC W-W PLUG HSG 20P BLUE

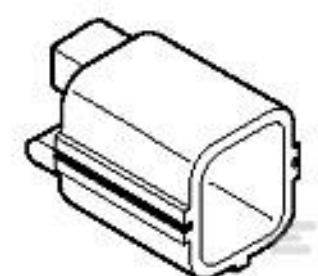

TE Part #174880-7
1 POS DL PLATE FOR CAP MK II+



TE Part #1-174878-1
E-J MK-2 PLUG HSG 1P NATURAL

Documents

Product Drawings

[070 ECONOSEAL MARK-2 PLATE 2P](#)

English

CAD Files

Customer View Model

[ENG_CVM_174353-7_C.3d_igs.zip](#)

English

Customer View Model

[ENG_CVM_174353-7_C.3d_stp.zip](#)

English

Customer View Model

[ENG_CVM_174353-7_C.2d_dxf.zip](#)

English

[3D PDF](#)

English

By downloading the CAD file I accept and agree to the [Terms and Conditions](#) of use.

Product Specifications



Product Specification

English

Product Specification

Japanese

Instruction Sheets

ECONOSEAL J MARK II+ CONNECTOR (EJ-MK II+)

English

Customer Manual (non U.S.)

English

ECONOSEAL J MARK II+ CONNECTOR

English

Customer Manual (non U.S.)

English