



enetSEAL+ | DEUTSCH Common Contact

TE Internal #: 1062-20-0344

Socket Terminal, 22 – 16 AWG, .35 – 1.5 mm² Wire, Gold (Au), 1 mm [.04 in] Pin Diameter, Family Seal or Unsealed, DEUTSCH Common Contact

[View on TE.com >](#)

Terminals & Splices > Automotive Terminals



Terminal Type: **Socket**

Wire Size: **22 – 16 AWG**

Interface Plating: **Gold (Au)**

Primary Locking Feature: **Integrated in Housing**

Features

Product Type Features

Receptacle Style	180°
Primary Locking Feature	Integrated in Housing
Sealable	No

Body Features

Terminal Seal Type	Family Seal or Unsealed
--------------------	-------------------------

Contact Features

Typical Current Rating	7.5 A
Crimp Type	F-Crimp
Contact Size	Size 20
Contact Fabrication	Stamped & Formed
Wire Contact Termination Area Plating Material	Tin
Terminal Type	Socket
Interface Plating	Gold (Au)
Mating Pin Diameter	1 mm [.04 in]

Termination Features

Termination Method to Wire & Cable	Crimp
Product Terminates To	Wire

Dimensions

Compatible Insulation Diameter Range	1.9 – 3.2 mm [.075 – .125 in]
--------------------------------------	-------------------------------



Wire Size	22 – 16 AWG
Wire Size Search	.35 mm ² , .5 mm ² , .75 mm ² , 1 mm ² , 1.5 mm ²

Usage Conditions

Insulation Option	Uninsulated
Operating Temperature (Max)	125 °C[257 °F]
Operating Temperature Range	-55 – 150 °C[-67 – 302 °F]

Operation/Application

Compatible With Wire Base Material	Copper
------------------------------------	--------

Packaging Features

Packaging Method	Reel
Packaging Quantity	4000

Other

Customer Preferred Contact	Yes
Terminal Transmits	0 – 24 A (Low Power)

Product Compliance

[For compliance documentation, visit the product page on TE.com>](#)









EU RoHS Directive 2011/65/EU	Compliant
EU ELV Directive 2000/53/EC	Compliant
China RoHS 2 Directive MIIT Order No 32, 2016	No Restricted Materials Above Threshold
EU REACH Regulation (EC) No. 1907/2006	Current ECHA Candidate List: JAN 2025 (247) Candidate List Declared Against: JAN 2025 (247) Does not contain REACH SVHC
Halogen Content	Low Halogen - Br, Cl, F, I < 900 ppm per homogenous material. Also BFR/CFR/PVC Free
Solder Process Capability	Not reviewed for solder process capability

Product Compliance Disclaimer

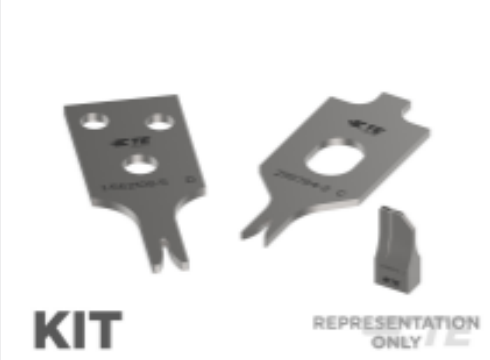
This information is provided based on reasonable inquiry of our suppliers and represents our current actual knowledge based on the information they provided. This information is subject to change. The part numbers that TE has identified as EU RoHS compliant have a maximum concentration of 0.1% by weight in homogenous materials for lead, hexavalent chromium, mercury, PBB, PBDE, DBP, BBP, DEHP, DIBP, and 0.01% for cadmium, or qualify for an exemption to these limits as defined in the Annexes of Directive 2011/65/EU (RoHS2). Finished electrical and electronic equipment products will be CE marked as required by Directive 2011/65/EU. Components may not be CE marked. Additionally, the part numbers that TE has identified as EU ELV compliant have a maximum concentration of 0.1% by weight in homogenous

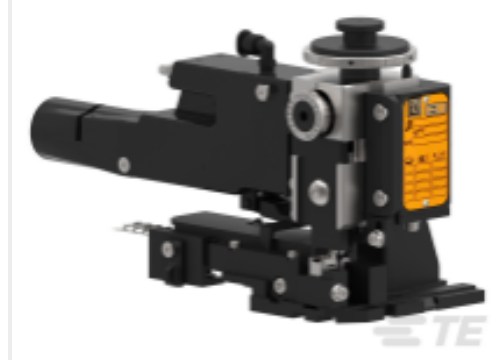
materials for lead, hexavalent chromium, and mercury, and 0.01% for cadmium, or qualify for an exemption to these limits as defined in the Annexes of Directive 2000/53/EC (ELV). Regarding the REACH Regulation, the information TE provides on SVHC in articles for this part number is based on the latest European Chemicals Agency (ECHA) 'Guidance on requirements for substances in articles' posted at this URL: <https://echa.europa.eu/guidance-documents/guidance-on-reach>

Compatible Parts

<p>TE Part # DRC26-50S10-C027 PLG, 50P, BLK, N, SPECIAL GROMMET, 10</p>	<p>TE Part # DRC26-60S02 PLG, 60P, BLK, N, 02</p>	<p>TE Part # DRC26-50S01-C027 PLG, 50P, BLK, N, SPECIAL GROMMET, 01</p>	<p>TE Part # DRC26-40SB-PL01 PLG, 40P, BLK, N, ROUTER CAP, SS CLIP, B</p>
<p>TE Part # DRC26-40SD-PL01 PLG, 40P, BLK, N, ROUTER CAP, SS CLIP, D</p>	<p>TE Part # DRC26-60S09 PLG, 60P, BLK, N, 09</p>	 <p>TE Part # 2266118-2 OCEAN_2.0_APPLICATOR-S-069F0800A-RSA</p>	 <p>TE Part # 1060-20-0244 PIN, SF, SIZE 20, 16-22, AU/SN</p>
 <p>TE Part # CAT-D48-ST273 DEUTSCH Solid Contacts</p>	 <p>TE Part # 7-2266116-7 OCEAN_2.0_SPARE_PART_KIT-069F1100</p>	 <p>TE Part # 5-2266116-1 OCEAN_2.0_Applicator-S-069F1100-RSM</p>	 <p>TE Part # 2266116-2 OCEAN_2.0_Applicator-S-069F1100-RSA</p>
 <p>TE Part # 2391435-1 SDE F PIN/SOCKET 16-18 ASSY</p>	 <p>TE Part # 1060-20-0144 PIN, SF, SIZE 20, 16-22, AU/SN</p>	 <p>TE Part # CAT-D485-CH8172 DEUTSCH DTM Housings</p>	 <p>TE Part # 2266117-2 OCEAN-2.0-APPLICATOR-S-069F0900A-RSA</p>



TE Part # DRCP28-86SB
PLG, 86P, BLK, 12/20, B

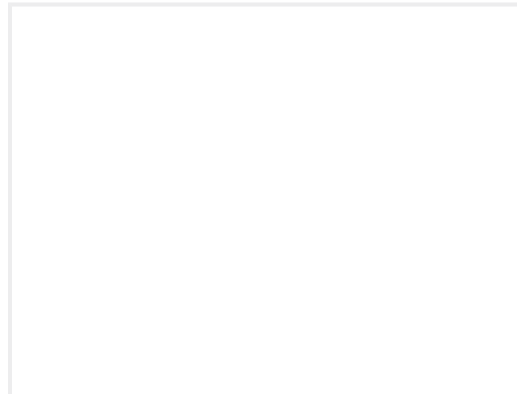

TE Part # DRC26-24SC-P017
PLG, 24P, BLK, N, SS CLIP, A

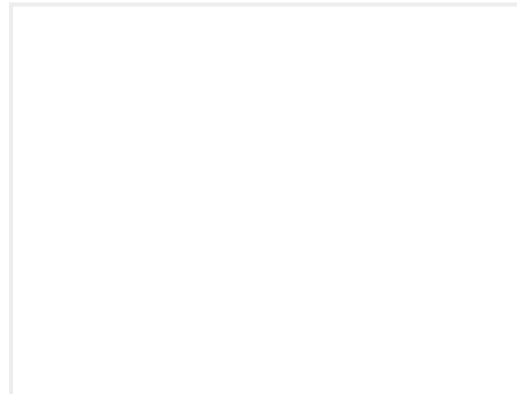

TE Part # DRC26-40SA-PL01
PLG, 40P, BLK, N, ROUTER CAP, SS CLIP, A

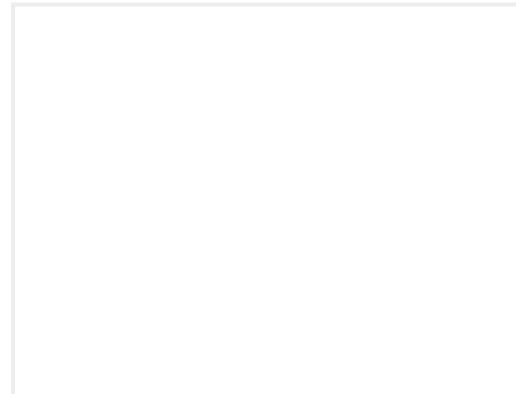

TE Part # DRC26-40SC-PL01
PLG, 40P, BLK, N, ROUTER CAP, SS CLIP, C

Also in the Series | DEUTSCH Common Contact

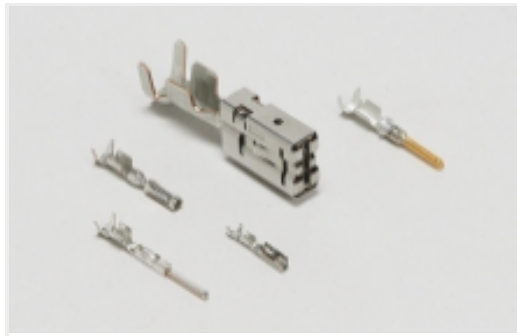

Automotive Terminals(127)

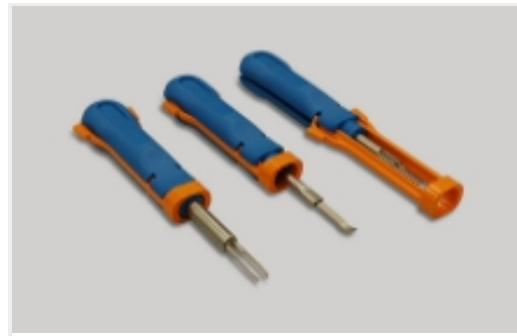

Insertion & Extraction Tools(8)

Customers Also Bought



TE Part #1060-20-0244
PIN, SF, SIZE 20, 16-22, AU/SN



TE Part #1060-20-0144
PIN, SF, SIZE 20, 16-22, AU/SN



TE Part #2292800-1
AS16, PLUG BACKSHELL KIT, ST, 06P, SMOOTH



TE Part #DRC20-60P05
HDR, 60P, BLK, ST, AU/NI/CU, 05



TE Part #DTP04-4P-E003
REC, 4P, GRY, N, CAP

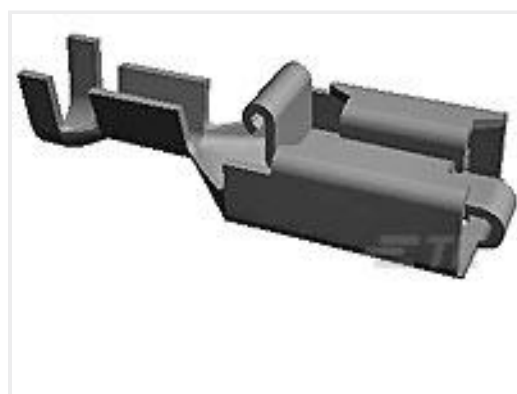

TE Part #927852-7
PL 250 REC TERMINAL 20-17 AWG PTPPB



TE Part #CAT-AM7801-T273
AMPSEAL 16 CONTACTS



TE Part #0528-007-6005
BKSHL, 60P, BLK, PLG, RA, SIDE, NW 26



TE Part #2378521-1
BACKSHELL, CONN KIT



Documents

Product Drawings

[SOC, SF, SIZE 20, 16-22, SLEVELESS, AU/SN](#)

English

CAD Files

[3D PDF](#)

3D

Customer View Model

[ENG_CVM_CVM_1062-20-0344_H.2d_dxf.zip](#)

English

Customer View Model

[ENG_CVM_CVM_1062-20-0344_H.3d_igs.zip](#)

English

Customer View Model

[ENG_CVM_CVM_1062-20-0344_H.3d_stp.zip](#)

English

By downloading the CAD file I accept and agree to the [Terms and Conditions](#) of use.

Datasheets & Catalog Pages

[DEUTSCH HD30 & HDP20 CONNECTOR SERIES](#)

English

[CONNECTOR SELECTOR](#)

English

Product Specifications

[Application Specification](#)

English