

1-962841-1 ✓ ACTIVE



AMP | Junior Power Timer, Timer Connector System

TE Internal #: 1-962841-1

Tab Terminal, 20 – 17 AWG, .5 – 1 mm² Wire, 2.8 mm [.11 in] Tab Width, Tin (Sn), .8 mm [.031 in] Tab Thickness, Timer Connector System

[View on TE.com >](#)

Terminals & Splices > Automotive Terminals > TIMER, RECEPTACLE AND TAB

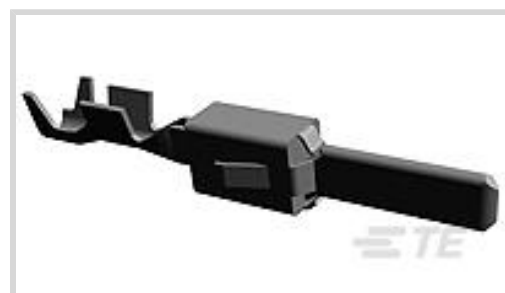

Terminal Type: **Tab**

Wire Size: **20 – 17 AWG**

Mating Tab Width: **2.8 mm [.11 in]**

Interface Plating: **Tin (Sn)**

[All TIMER, RECEPTACLE AND TAB \(279\)](#)

Features

Product Type Features

Receptacle Style	180°
Primary Locking Feature	Locking Lance
Sealable	No

Contact Features

Typical Current Rating	30 A
Crimp Type	F-Crimp
Contact Size	2.8mm
Contact Fabrication	Stamped & Formed
Wire Contact Termination Area Plating Material	Tin
Terminal Type	Tab
Mating Tab Width	2.8 mm [.11 in]
Interface Plating	Tin (Sn)
Mating Tab Thickness	.8 mm [.031 in]

Termination Features

Termination Method to Wire & Cable	Crimp
Product Terminates To	Wire

Dimensions

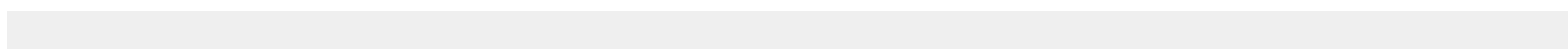



Compatible Insulation Diameter Range	1.4 – 2.1 mm [.055 – .083 in]
Wire Size	20 – 17 AWG
Wire Size Search	.5 mm ² , .6 mm ² , .75 mm ² , 1 mm ²
Tab Length	26.7 mm [1.05 in]

Usage Conditions

Insulation Option	Uninsulated
Operating Temperature (Max)	130 °C [266 °F]
Operating Temperature Range	-40 – 130 °C [-40 – 266 °F]

Operation/Application

Compatible With Wire Base Material	Copper
Conforms to Automation Guideline	Yes, DIN 72036 Automation of Wiring Harness Production, Version June 2024, Yes, KOMAX Guideline for automatic component insertion for electrical connections, Version 5.0 (March 2018)

Industry Standards

Compatible With Agency/Standards Products	LV214
---	-------

Packaging Features

Packaging Method	Reel
Packaging Quantity	4000

Other

Terminal Transmits	25 – 40 A (Power)
--------------------	-------------------

Product Compliance

[For compliance documentation, visit the product page on TE.com>](#)

EU RoHS Directive 2011/65/EU	Compliant
EU ELV Directive 2000/53/EC	Compliant
China RoHS 2 Directive MIIT Order No 32, 2016	No Restricted Materials Above Threshold
EU REACH Regulation (EC) No. 1907/2006	Current ECHA Candidate List: JAN 2025 (247) Candidate List Declared Against: JAN 2025 (247) Does not contain REACH SVHC
Halogen Content	Low Halogen - Br, Cl, F, I < 900 ppm per homogenous material. Also BFR/CFR/PVC Free

Solder Process Capability

Not applicable for solder process capability

Product Compliance Disclaimer

This information is provided based on reasonable inquiry of our suppliers and represents our current actual knowledge based on the information they provided. This information is subject to change. The part numbers that TE has identified as EU RoHS compliant have a maximum concentration of 0.1% by weight in homogenous materials for lead, hexavalent chromium, mercury, PBB, PBDE, DBP, BBP, DEHP, DIBP, and 0.01% for cadmium, or qualify for an exemption to these limits as defined in the Annexes of Directive 2011/65/EU (RoHS2). Finished electrical and electronic equipment products will be CE marked as required by Directive 2011/65/EU. Components may not be CE marked. Additionally, the part numbers that TE has identified as EU ELV compliant have a maximum concentration of 0.1% by weight in homogenous materials for lead, hexavalent chromium, and mercury, and 0.01% for cadmium, or qualify for an exemption to these limits as defined in the Annexes of Directive 2000/53/EC (ELV). Regarding the REACH Regulation, the information TE provides on SVHC in articles for this part number is based on the latest European Chemicals Agency (ECHA) 'Guidance on requirements for substances in articles' posted at this URL: <https://echa.europa.eu/guidance-documents/guidance-on-reach>

Compatible Parts



KIT
REPRESENTATION ONLY

TE Part # 7-2836795-7
TOOLING KIT TO MAKE LOOSE PIECE TERMINAL



TE Part # 1801735-5
18W HYBRID UNSEALED RCPT HSG ASSY PURPLE



TE Part # 2836795-1
APPLICATOR TO MAKE LOOSE PC TERMINAL-RSM



TE Part # 2236046-8
32POS, MIXED, MALE CONN., CLIP2, COD B



TE Part # 1801735-3
18W HYBRID UNSEALED RCPT HSG ASSY BLUE



TE Part # 1801735-4
18W HYBRID UNSEALED RCPT HSG ASSY BROWN

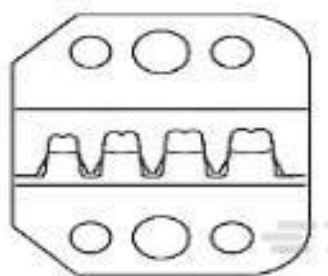

TE Part # 58603-2
PROCRIMP DIE JPT 2.8MM TAB



TE Part # 2484266-1
33POS, HYBRID, TAB HSG ASSY, UNSLD, COD A



TE Part # 2-2322192-1
18POS, 2.8X0.8, TAB HSG, COD B



TE Part # 968908-1
KREUZKONTAKT 2,8



TE Part # 1-1579007-6
EXTRACTION TOOL



TE Part # 2305570-1
Strip Terminal Cutter-Side Feed-No Crimp

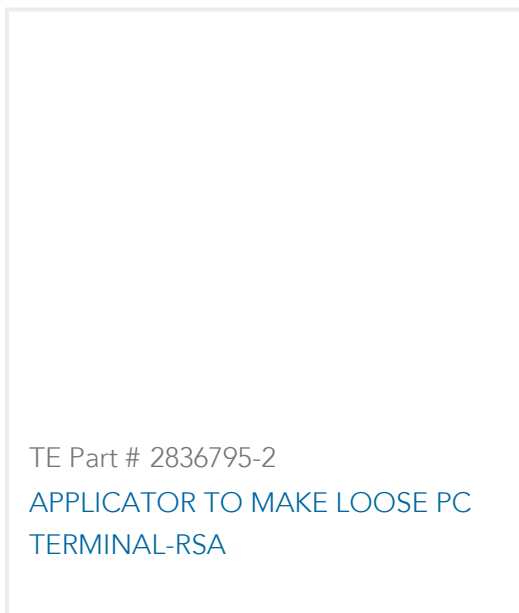

TE Part # 2836795-2
APPLICATOR TO MAKE LOOSE PC
TERMINAL-RSA



TE Part # CAT-M9194-CH8172
MULTILOCK, CONNECTOR HOUSING



TE Part # 1-2236046-0
32W, MIXED, MALE CONN., CLIP2,
COD A, CPA



TE Part # 2379922-4
21POS, AMP MCP 2.8, TAB HSG,
UNSLD, COD D



TE Part # 5-2151267-1
OCEAN_2.0 APPLICATOR-S-
080F1000-RSM



TE Part # 2379922-2
21POS, AMP MCP 2.8, TAB HSG,
UNSLD, COD B



TE Part # 2379922-1
21POS, AMP MCP 2.8, TAB HSG,
UNSLD, COD A



TE Part # 4-1579007-3
EXTRACTION TOOL KIT

Also in the Series | **Junior Power Timer**

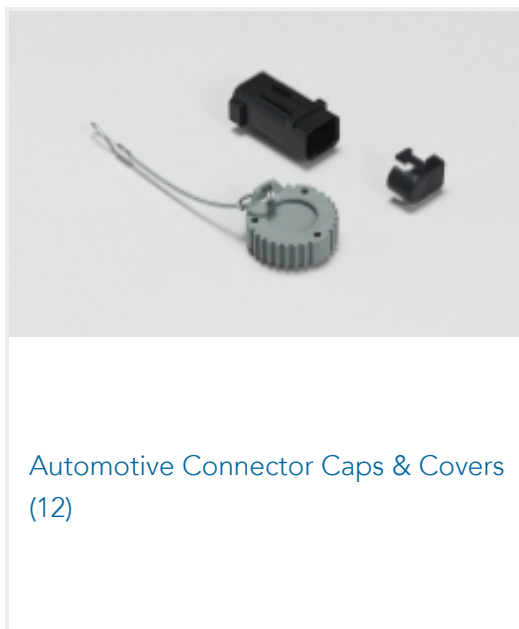

Automotive Connector Caps & Covers
(12)



Automotive Connector Locks &
Position Assurance(15)

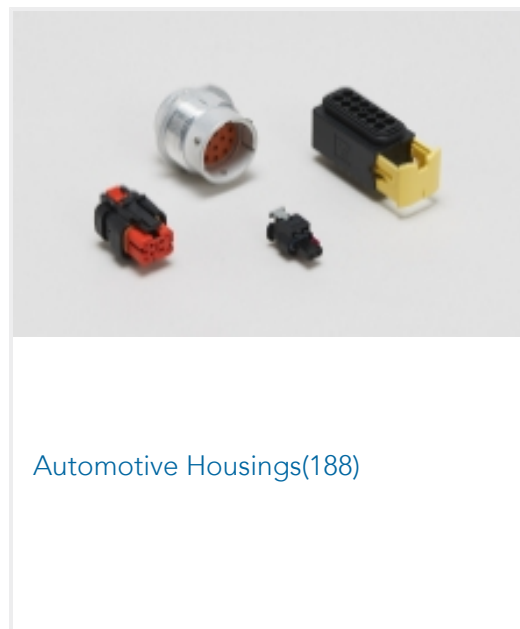

Automotive Housings(188)

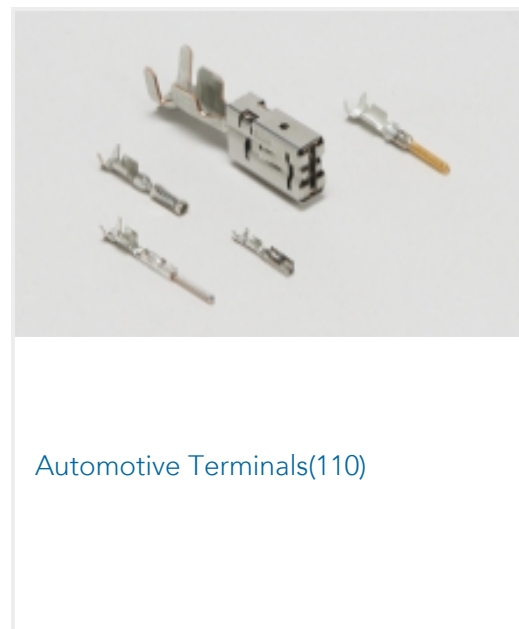

Automotive Terminals(110)

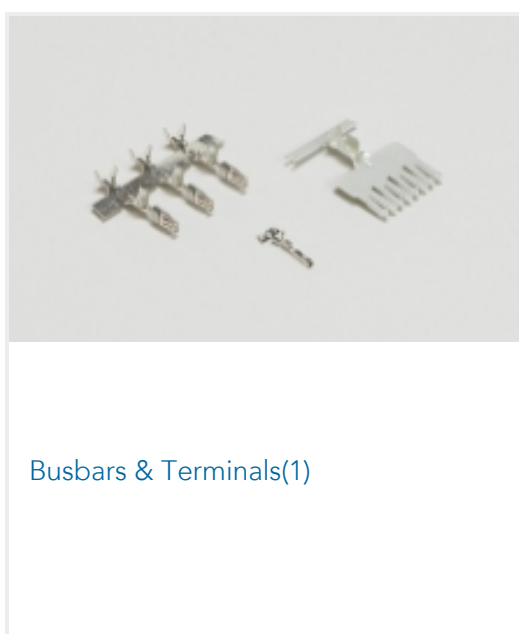

Busbars & Terminals(1)

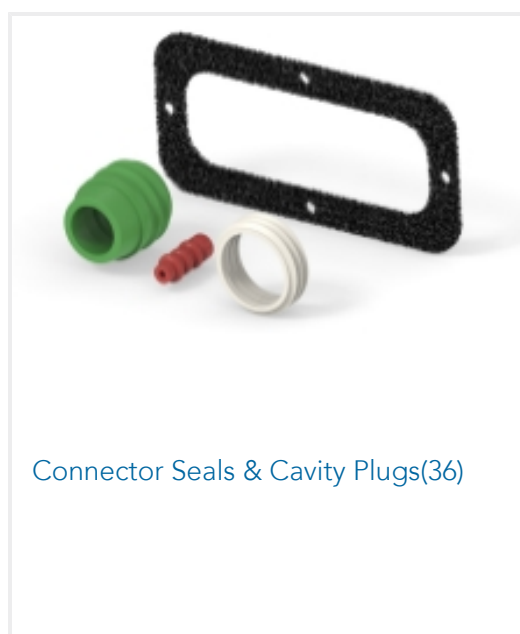

Connector Seals & Cavity Plugs(36)

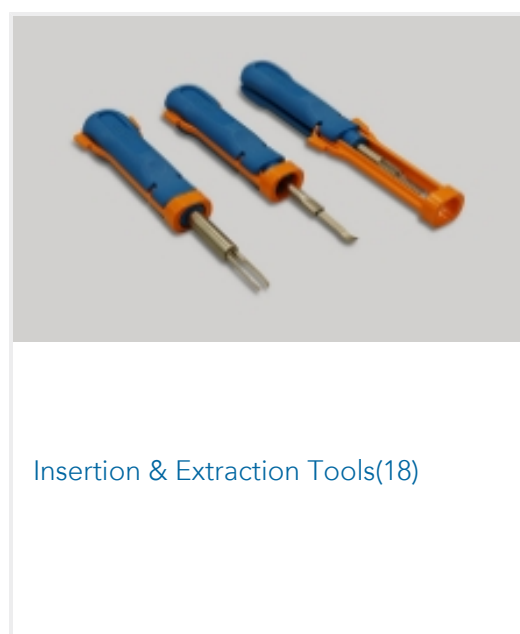

Insertion & Extraction Tools(18)



Module Components(1)

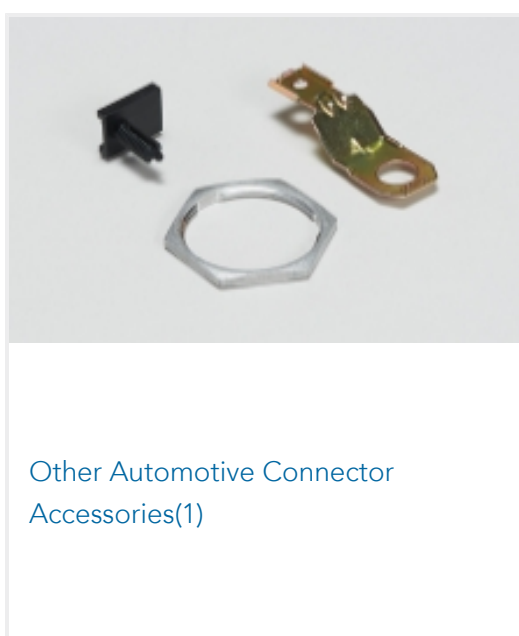

Other Automotive Connector
Accessories(1)

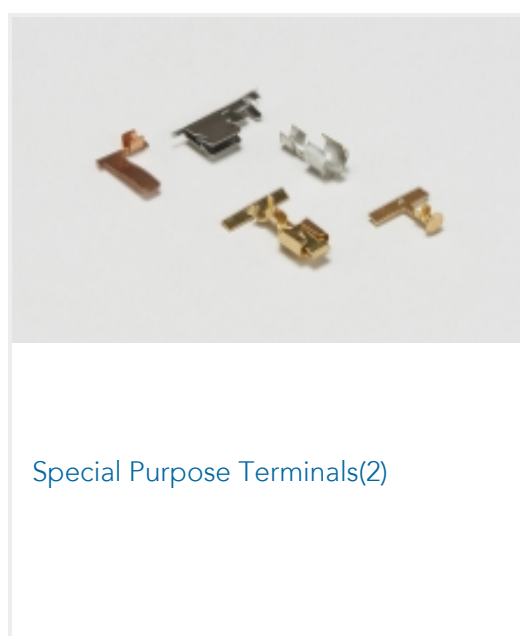

Special Purpose Terminals(2)

Also in the Series | **Timer Connector System**

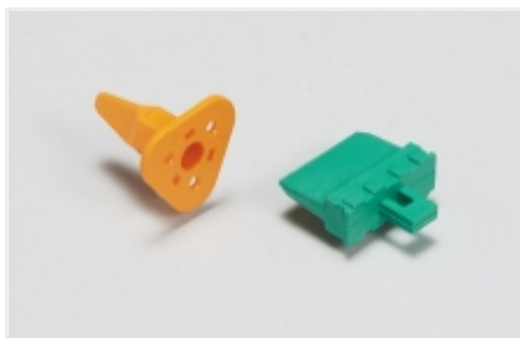

Automotive Connector Locks & Position Assurance(15)



Automotive Headers(19)

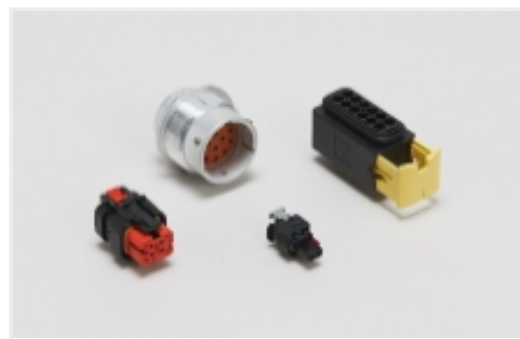

Automotive Housings(188)



Connector Seals & Cavity Plugs(36)

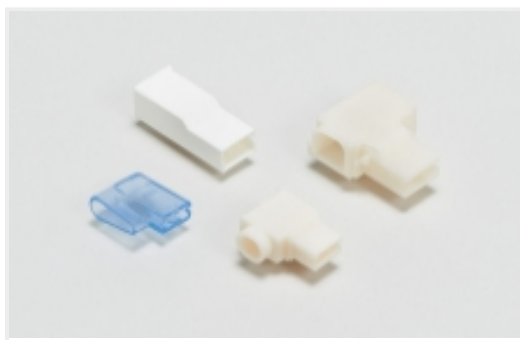

Crimp Terminal Housings(13)

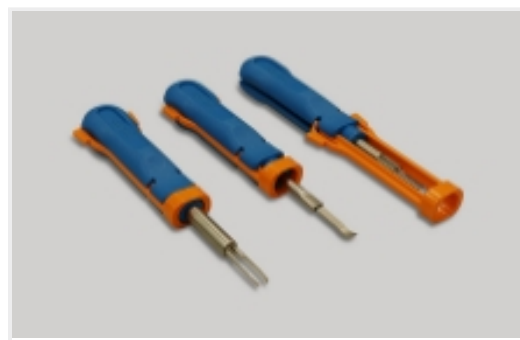

Insertion & Extraction Tools(18)

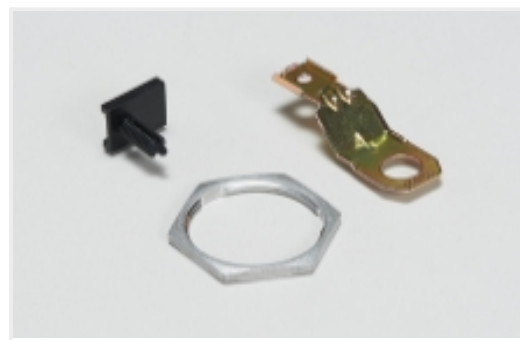

Other Automotive Connector Accessories(1)

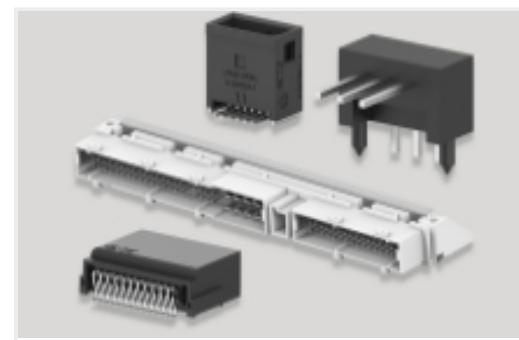

PCB Headers & Receptacles(19)



Rectangular Power Connectors(2)

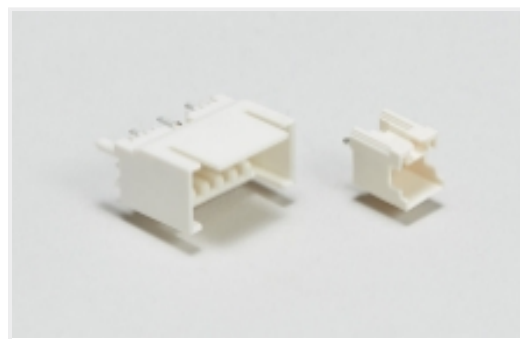

Wire-to-Board Headers & Receptacles (19)

Customers Also Bought



TE Part #CAT-AM705-CH8173
AMP Unsealed Connector Housing



TE Part #CAT-J96-ULPA
Unsealed Locks and Position Assurance



TE Part #CAT-T4827-CH8172
Timer Connector Housing



TE Part #1452128-3
MQS ST-KONT M.FFC



TE Part #1-962842-1
TAB 2.8x0.8 CONTACT CS SRC Sn

Documents



Product Drawings

[TAB 2.8x0.8 CONTACT CS SRC Sn](#)

English

[TAB 2.8x0.8 CONTACT CS SRC Sn](#)

English

CAD Files

Customer View Model

[ENG_CVM_CVM_1-962841-1_F.2d_dxf.zip](#)

English

[3D PDF](#)

3D

Customer View Model

[ENG_CVM_CVM_1-962841-1_F.3d_igs.zip](#)

English

Customer View Model

[ENG_CVM_CVM_1-962841-1_F.3d_stp.zip](#)

English

By downloading the CAD file I accept and agree to the [Terms and Conditions](#) of use.

Product Specifications

[Application Specification](#)

English

[Application Specification](#)

German

[Application Specification](#)

English

[Application Specification](#)

English