



Neohm | Neohm RR

TE Internal #: 1-1879353-8

22K ohm, Through-Hole Power Resistor, Metal Film, 2 W, 5 %, ±300

ppm/°C, Axial-Leaded, Copper Termination, 9 x 3.5 mm, Ammo

Packed, Neohm RR

[View on TE.com >](#)

Passive Components > Resistors > Through-Hole Resistors



Resistance Value: **22K Ω**

Resistor Type: **Power Resistor**

Element Type: **Metal Film**

Power Rating: **2 W**

Resistance Class: **1kΩ – 1MΩ**

Features

Product Type Features

Resistor Type	Power Resistor
Element Type	Metal Film

Configuration Features

Number of Resistors	1
---------------------	---

Electrical Characteristics

Operating Voltage	500 V
Resistance Value	22K Ω
Power Rating	2 W
Resistance Class	1kΩ – 1MΩ
Passive Component Tolerance	5 %

Body Features

Lead Type	Axial-Leaded
-----------	--------------

Termination Features

Termination Area Base Material	Copper
Number of Terminations	2

Dimensions

Passive Component Dimensions	9 x 3.5 mm
------------------------------	------------



Usage Conditions

Temperature Coefficient	±300 ppm/°C
-------------------------	-------------

Packaging Features

Packaging Method	Ammo Packed
------------------	-------------

Product Compliance

[For compliance documentation, visit the product page on TE.com>](#)

EU RoHS Directive 2011/65/EU	Compliant
EU ELV Directive 2000/53/EC	Compliant
China RoHS 2 Directive MIIT Order No 32, 2016	No Restricted Materials Above Threshold
EU REACH Regulation (EC) No. 1907/2006	Current ECHA Candidate List: JAN 2025 (247) Candidate List Declared Against: JAN 2025 (247) Does not contain REACH SVHC
Halogen Content	Low Halogen - Br, Cl, F, I < 900 ppm per homogenous material. Also BFR/CFR/PVC Free
Solder Process Capability	Wave solder capable to 265°C

Product Compliance Disclaimer

This information is provided based on reasonable inquiry of our suppliers and represents our current actual knowledge based on the information they provided. This information is subject to change. The part numbers that TE has identified as EU RoHS compliant have a maximum concentration of 0.1% by weight in homogenous materials for lead, hexavalent chromium, mercury, PBB, PBDE, DBP, BBP, DEHP, DIBP, and 0.01% for cadmium, or qualify for an exemption to these limits as defined in the Annexes of Directive 2011/65/EU (RoHS2). Finished electrical and electronic equipment products will be CE marked as required by Directive 2011/65/EU. Components may not be CE marked. Additionally, the part numbers that TE has identified as EU ELV compliant have a maximum concentration of 0.1% by weight in homogenous materials for lead, hexavalent chromium, and mercury, and 0.01% for cadmium, or qualify for an exemption to these limits as defined in the Annexes of Directive 2000/53/EC (ELV). Regarding the REACH Regulation, the information TE provides on SVHC in articles for this part number is based on the latest European Chemicals Agency (ECHA) 'Guidance on requirements for substances in articles' posted at this URL: <https://echa.europa.eu/guidance-documents/guidance-on-reach>

Compatible Parts





Also in the Series | Neohm RR



Customers Also Bought

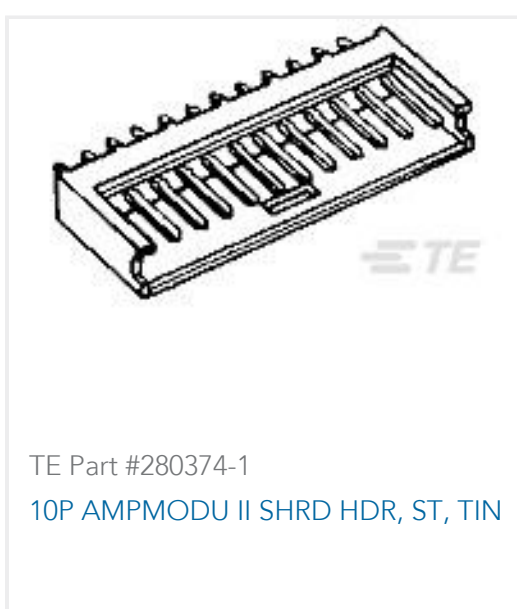
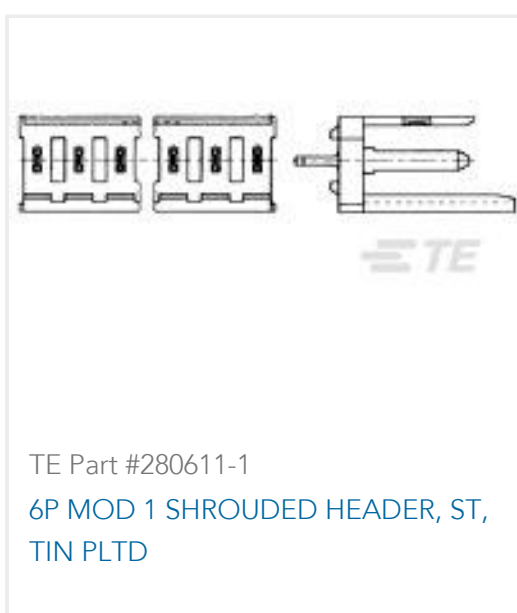



Documents

Product Drawings

[RR02 5% 22K AMMO](#)

English

CAD Files

[3D PDF](#)

3D

Customer View Model

[ENG_CVM_CVM_1-1879353-8_BA.2d_dxf.zip](#)

English

Customer View Model

[ENG_CVM_CVM_1-1879353-8_BA.3d_igs.zip](#)

English

Customer View Model

[ENG_CVM_CVM_1-1879353-8_BA.3d_stp.zip](#)

English

By downloading the CAD file I accept and agree to the [Terms and Conditions](#) of use.

Datasheets & Catalog Pages

[4-1773460-6_RESISTIVE_SOLUTIONS_RAIL](#)

English

[1309350_PASSIVE_COMPONENT](#)

English

[8-1773459-4_POWER_FILTERING_AND_RESISTIVE_SOLUTIONS_FOR_ELEVATORS_AND_ESCALATORS](#)

English

[Power Resistor - Type RR Series - Tyco Electronics Passives](#)

English