

## TMX-221Acc3B

### WiFi 7/6E Whip Antenna

The Joymax TMX-221Acc3B antenna is a whip-style, right-angle monopole antenna designed for use in 2.4 GHz, 5 GHz and 6 GHz bands supporting WiFi 7, WiFi 6E, WiFi 6, WiFi 5, and WiFi 4 applications.

The low-profile, right-angle design greatly reduce the possible length of antenna housing. They are further ideal for product requiring compact size antenna in a fixed right-angle form factor. The antenna is available with an RP-SMA Plug (female socket) connector and SMA plug (male pin) connector.



#### Features

- Broad bandwidth 2.4 GHz to 7.125 GHz
- Performance at 2400 MHz to 2500 MHz
  - VSWR:  $\leq 1.5$
  - Peak Gain: 1.1 dBi
  - Efficiency: 49%
- Performance at 5150 MHz to 5850 MHz
  - VSWR:  $\leq 2.5$
  - Peak Gain: 3.0 dBi
  - Efficiency: 62%
- Low profile, light weight
- RP-SMA plug (female socket) or SMA plug (male pin) connector

#### Applications

- WiFi/WLAN applications:
  - WiFi 7 (802.11be)
  - WiFi 6E (802.11ax)
  - WiFi 6 (802.11ax)
  - WiFi 5 (802.11ac)
  - WiFi 4 (802.11n)
- 2.4 GHz ISM applications:
  - Bluetooth®
  - ZigBee®
  - Thread®
  - IEEE 802.15.4
  - IEEE 802.11b/g
- Internet of Things (IoT) devices

#### Ordering Information

Part Number	Description
<b>TMX-221ARS3B</b>	WiFi 7/6E Right-Angle Whip Antenna with RP-SMA plug (female socket) connector
<b>TMX-221ASA3B</b>	WiFi 7/6E Right-Angle Whip Antenna with SMA plug (male pin) connector

Available from Joymax Electronics and select distributors and representatives.

**Table 1: Electrical Specifications**

TMX-221Acc3B	WiFi / WLAN Band (MHz)		
Frequency Range	2400~2500	5150~5850	5925-7125
VSWR (Max)	1.5	2.5	3.0
Peak Gain (dBi)	1.1	3.0	3.5
Average Gain (dBi)	-3.1	-2.2	-2.2
Efficiency (%)	49	62	61
Polarization	Linear		
Radiation	Omni directional		
Max Power	1 W		
Wavelength	$\frac{1}{4}\lambda$		
Electrical Type	Monopole		
Impedance	50 $\Omega$		

Electrical specifications and plots measured with the antenna hanging free in the space without ground plane.

**Table 2: Mechanical Specifications**

Parameter	Value
Connection	RP-SMA Plug (female socket) or SMA Plug (male pin) connector
Operating Temp.	-30°C to +70°C
Weight	6.5 g
Dimension	47 mm x $\varnothing$ 8mm
Antenna Color	Black
Ingress Protection	N/A

**Packaging Information**

The TMX-221Acc3B antennas are individually sealed in a clear plastic bag. **Figure 1.** 1000 pcs per carton, 320 mm x 250 mm x 230 mm (12.6 in x 9.8 in x 9.1 in), total weight 7.9 kgs (17.4 lb) Distribution channels may offer alternative packaging options.

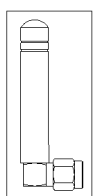

1 pc antenna/ 1 PE bag

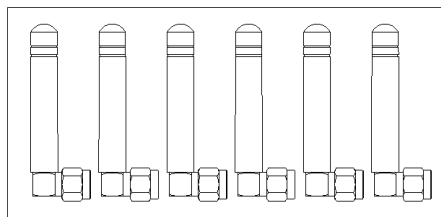

50 pcs antenna/1 Bigger PE bag

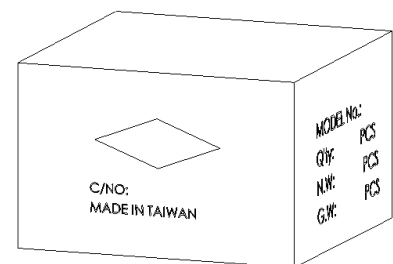

1000 pcs antenna/1 Carton

**Figure 1. Antenna Packaging**

### Product Dimensions

Figure 2 provides dimensions of the TMX-221Acc3B in mm measurement unit. The low-profile, right-angle rotating design makes antenna ideal in compact antenna configuration. The fixed right-angle base allows the antenna to be more adaptive and functional in compact surrounding than other antennas.

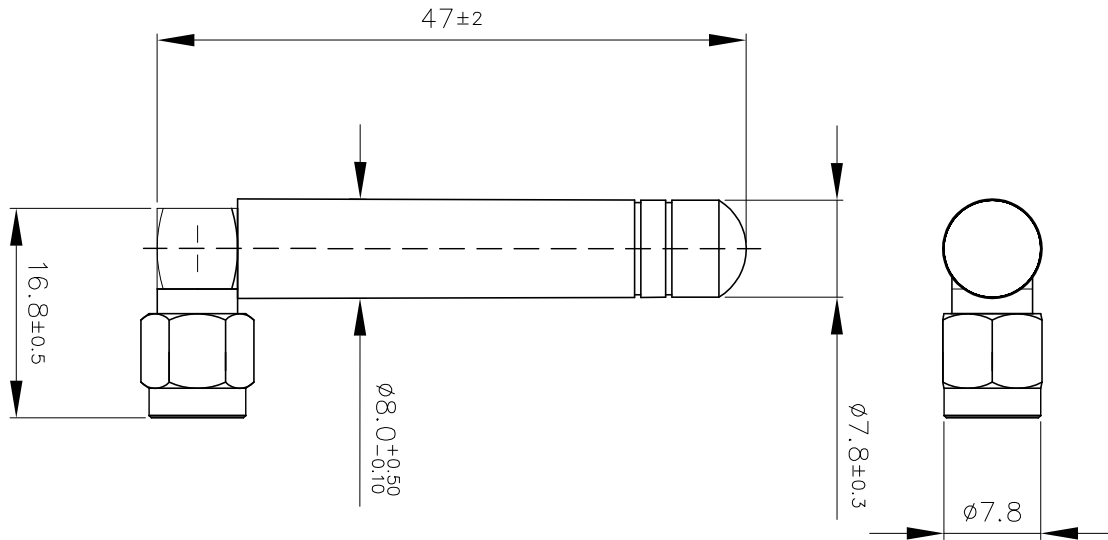

Figure 2. Antenna Dimensions

### Antenna Orientation

The TMX-221Acc3B antenna is characterized in 90 degrees antenna orientations as shown in Figure 3. The antenna orientation characterizes use of an antenna attached to enclosure-mounted connector. The 90 degree bent orientation represents the most common end-product use cases. The charts on the following pages represent data taken with the antenna oriented in free space without ground plane.



Figure 3. Antenna Test Orientation

### VSWR

Figure 4 provides the voltage standing wave ratio (VSWR) across the antenna bandwidth. VSWR is a function of the reflection coefficient, which describes the power reflected from the antenna back to the radio. A lower VSWR value indicates better antenna performance at a given frequency. Reflected power is also shown on the right-side vertical axis as a gauge of the percentage of transmitter power reflected back from the antenna.

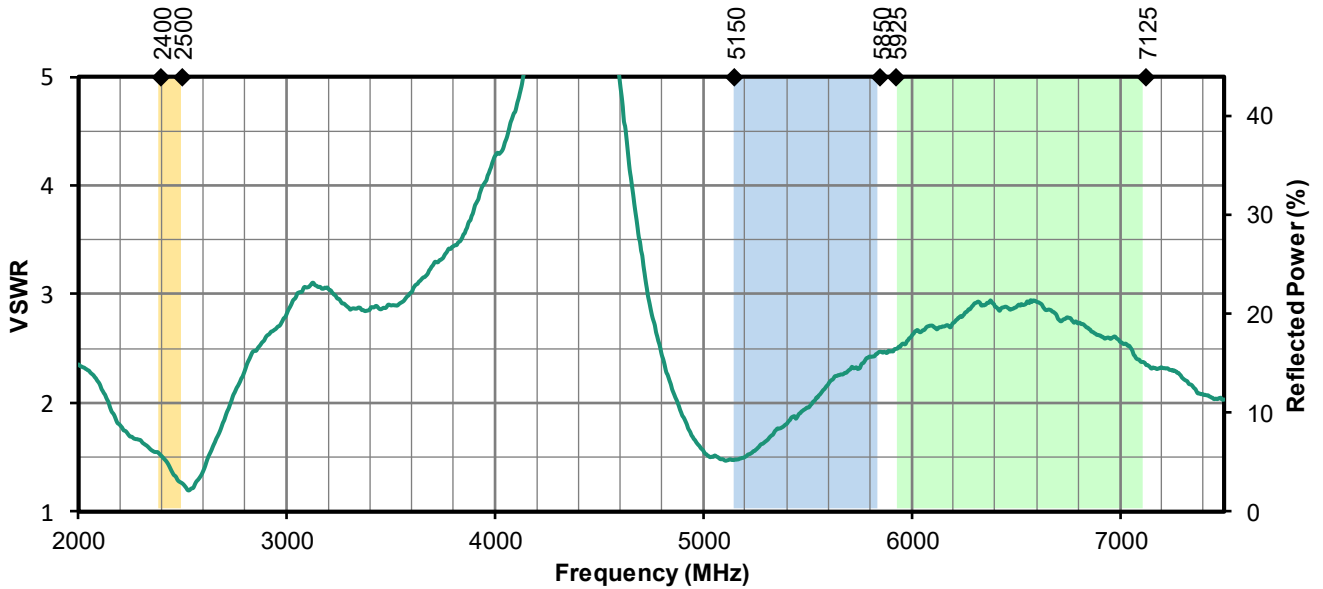

Figure 4. Antenna VSWR

### Return Loss

Return loss (Figure 5), represents the loss in power at the antenna due to reflected signals. Like VSWR, a lower return loss value indicates better antenna performance at a given frequency.

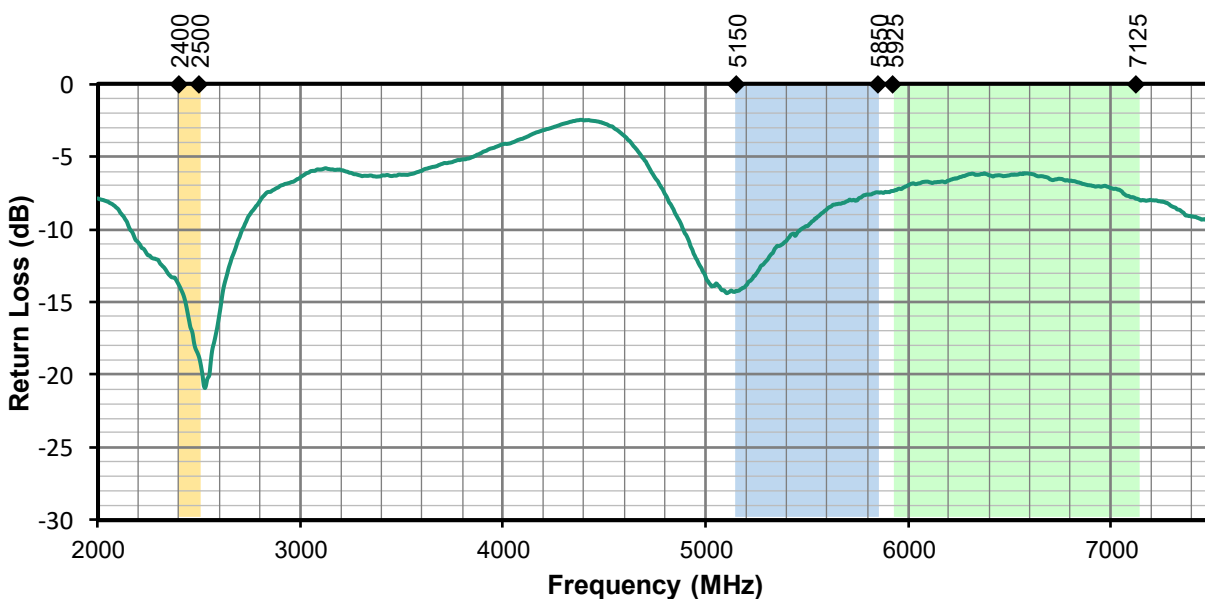

Figure 5. Antenna Return Loss

### Peak Gain

The peak gain across the antenna bandwidth is shown in **Figure 6**. Peak gain represents the maximum antenna input power concentration across 3-dimensional space, and therefore peak performance at a given frequency, but does not consider any directionality in the gain pattern.

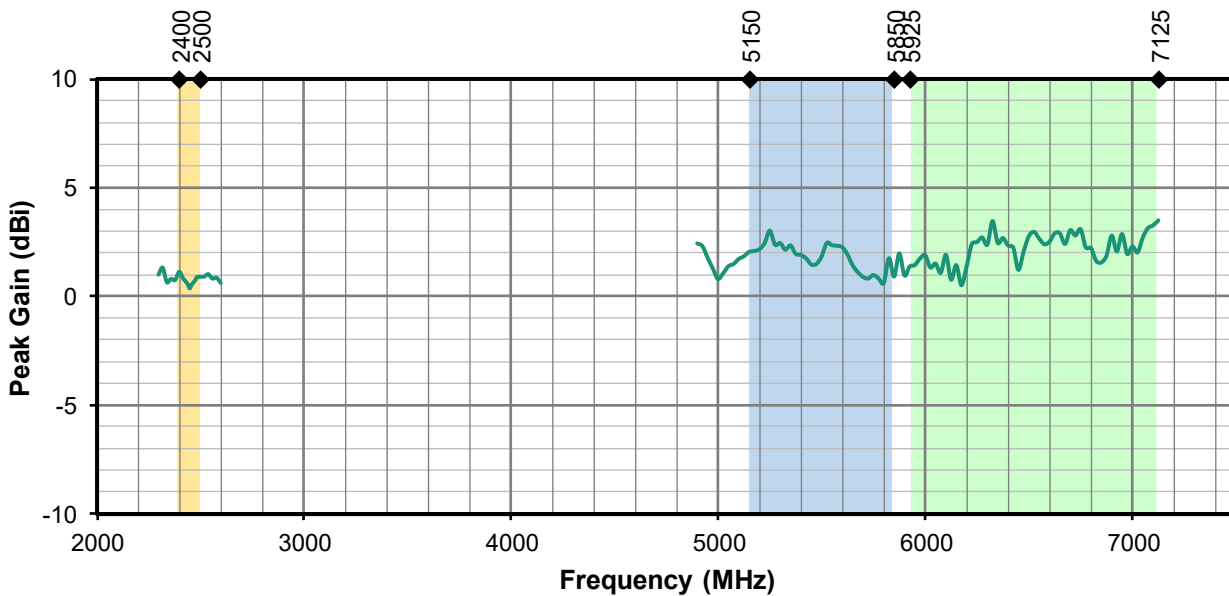

Figure 6. Antenna Peak Gain

### Average Gain

Average gain (**Figure 7**), is the average of all antenna gain in 3-dimensional space at each frequency, providing an indication of overall performance without expressing antenna directionality.

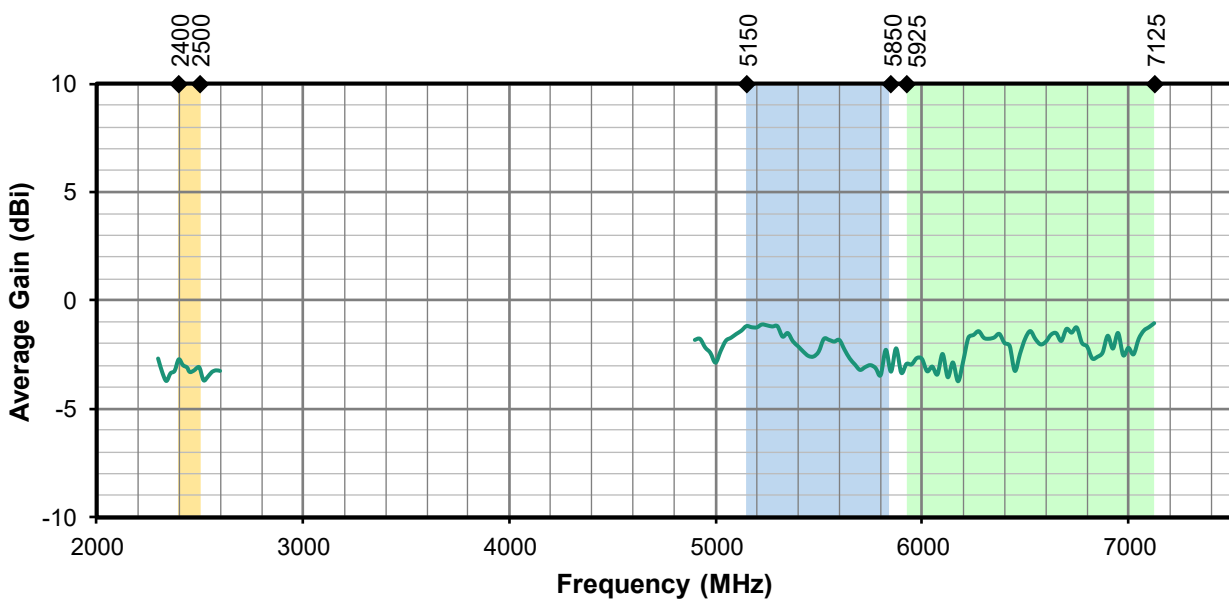

Figure 7. Antenna Average Gain

### Radiation Efficiency

Radiation efficiency (**Figure 8**), shows the ratio of power radiated by the antenna relative to the power supplied to the antenna, expressed as a percentage, where a higher percentage indicates better performance at a given frequency. An ideal antenna has 100% efficiency. But in really world, usually an external antenna radiates only 50~60% of power supplied to it.

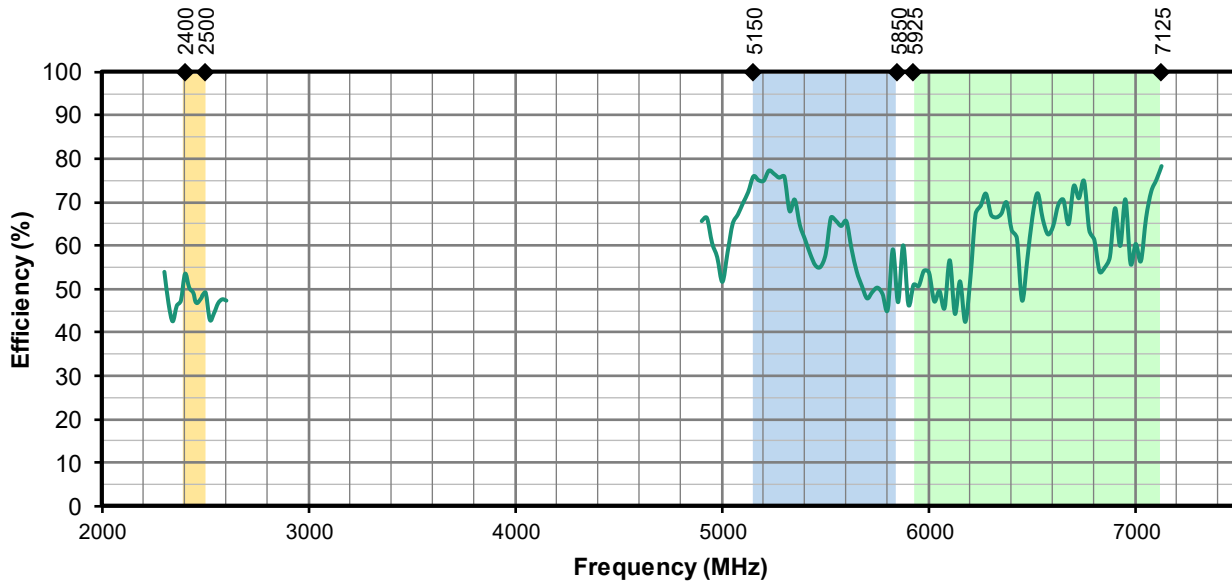
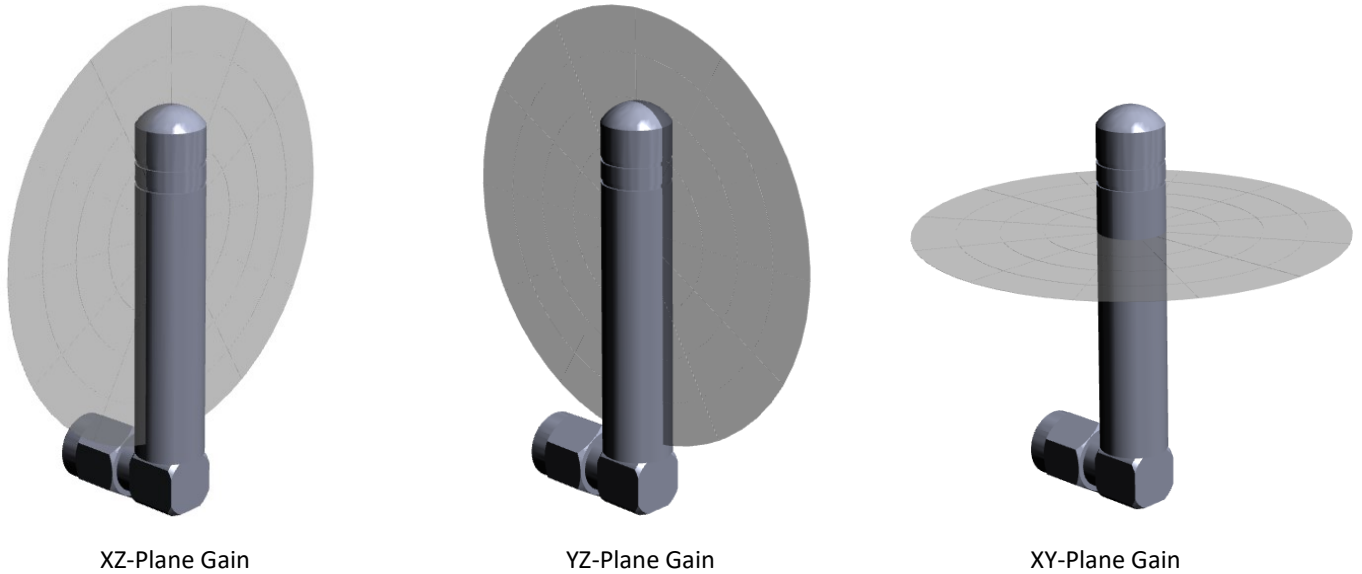

Figure 8. Antenna Efficiency

### Radiation Patterns

Radiation patterns provide information about the directionality and 3-dimensional gain performance of the antenna by plotting gain at specific frequencies in three orthogonal planes. Antenna radiation patterns for a R/A orientation are shown in **Figure 9** using polar plots covering 360 degrees. The antenna graphic at the top of the page provides reference to the plane of the column of plots below it.



### 2400 MHz to 2500 MHz (2450 MHz)

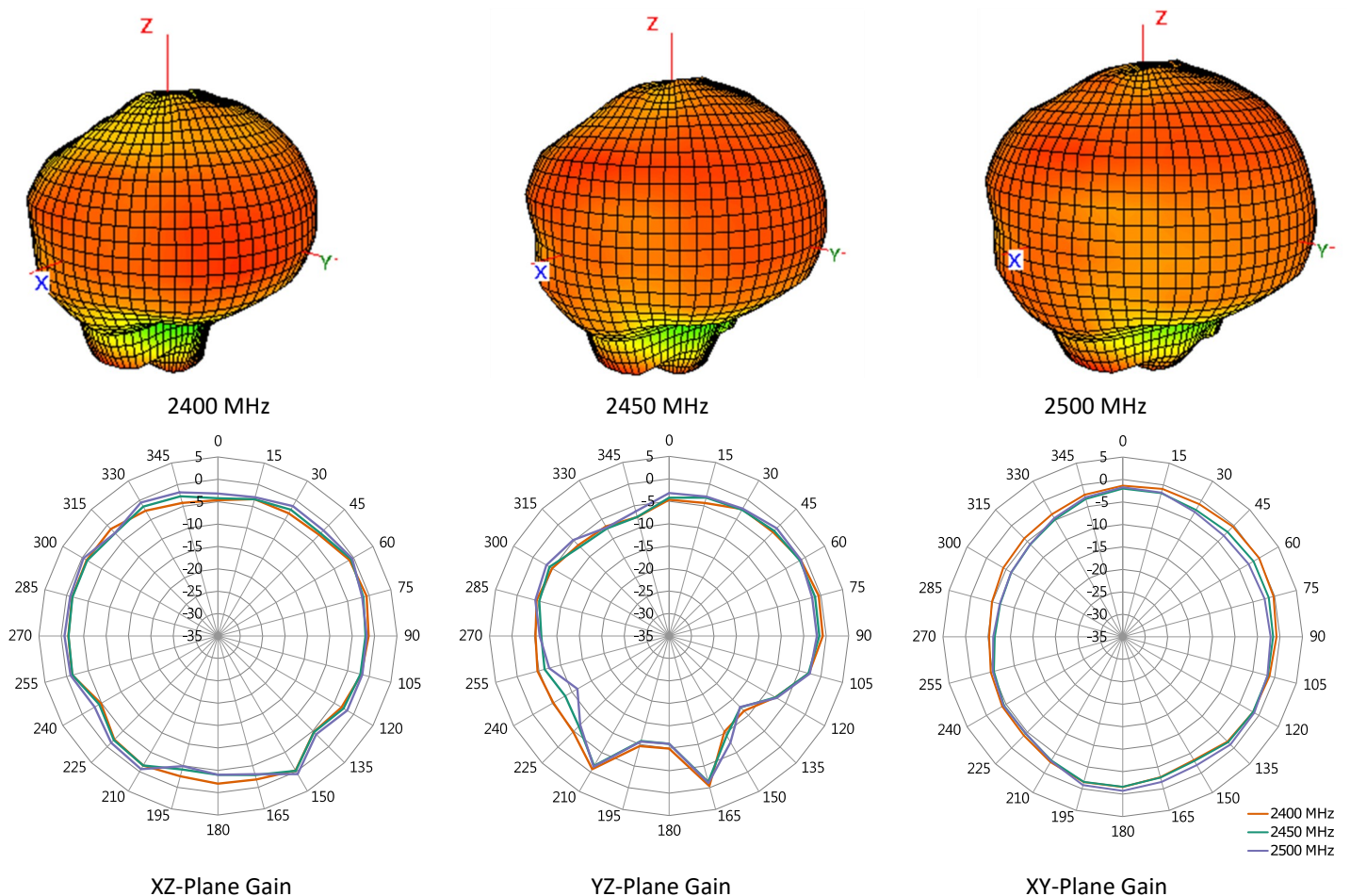
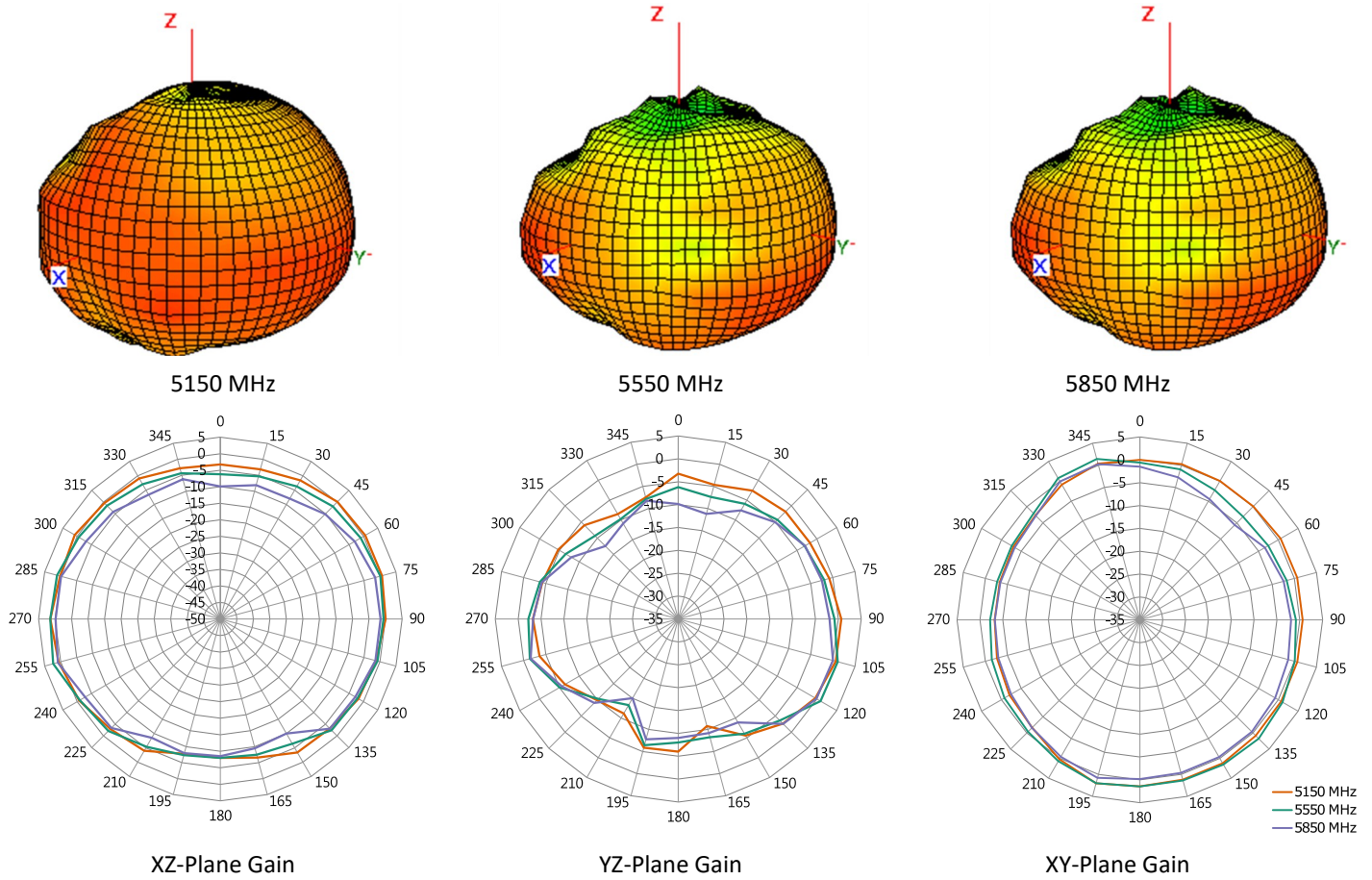

Figure 9. Antenna Radiation Patterns

5150 MHz to 5850 MHz (5550 MHz)



5925 MHz to 7125 MHz (6525 MHz)

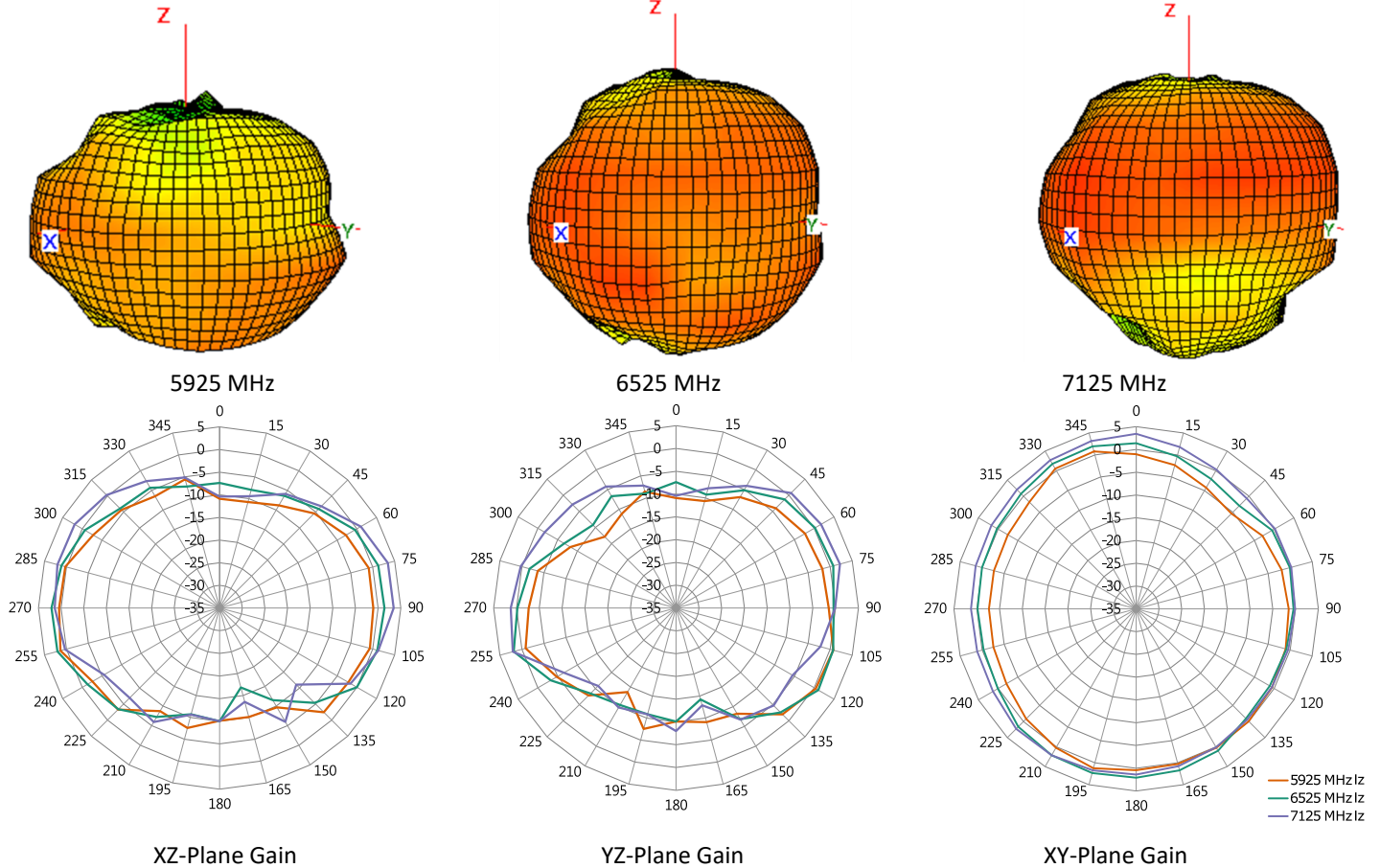

Figure 9-1. Antenna Radiation Patterns

## Antenna FAQs

### Q: What is an antenna?

An antenna is used for transmission or reception of radio signals in wireless communication.

### Q: How do antennas work?

Electricity flowing into the transmitter antenna makes electrons vibrate up and down it, producing radio waves. The radio waves travel through the air at the speed of light. When the waves arrive at the receiver antenna, they make electrons vibrate inside it.

### Q: Does antenna size matter?

A bigger antenna, properly designed, will always have more **gain** than a smaller one. And it will be the best kind of **gain**, much better than using a small antenna and simply over-amplifying it, because a small antenna just won't pull in truly weak signals like this gigantic one will.

### Q: What is the advantage of external antennas?

External antennas usually offer **better bandwidth** and **high performance** due to the nature of their larger size. This often results in a higher rated **gain** (dBi) than their internal counterparts. Due to its smaller size, an internal antenna would not function well to support lower frequencies.

Ease of integration – an external antenna requires fewer design resources and shorter time to integrate to allow for a more rapid time-to-market. An internal antenna's performance is influenced by device environment – PCB ground plane, nearby metal part, and enclosure. That would require much more effort such as impedance matching network to complete antenna design.





### Q: Why is most antenna impedance 50 Ohm?

50 Ohm is an industry standard of coax cables and power amplifiers. It was chosen as a tradeoff between maximum power handling for the transmit coax and the copper losses. The optimum would have been anyway in the range of **30 to 100 ohm** with average at 50 Ohm.

### Q: Why does GNSS require RHCP (Right-hand-circularly-polarized) antennas?

Satellite's signal has a low power density, especially after propagating through the **atmosphere** (**ionosphere** affect radio wave). Polarized waves oscillate in more than one direction, which deliver satellite's signal to receiver on Earth surface more effectively.

**MATING COMPONENTS: RF COAXIAL CONNECTOR AND CABLE ASSEMBLY**

Part Number	Image	Connector 1 (Receptacle)	Connector 2 (Plug)	Cable Length		Cable Diameter (mm)
				mm	Inch	
<a href="#">CX-SAS0MMPA1W0007</a>		SMA Jack Female Socket Straight	MHF1	70	2.76	1.13
<a href="#">CT-SAB11X-006M</a>		SMA Jack Female Socket Right Angle	N/A	N/A	N/A	N/A
<a href="#">CT-SAD12X-006M</a>		RP-SMA Jack Male Pin Straight	N/A	N/A	N/A	N/A
<a href="#">CT-SAD11X-006M</a>		RP-SMA Jack Male Pin Right Angle	N/A	N/A	N/A	N/A

Website: <https://www.joymax.com.tw>  
 Offices: 5, Dong-Yuan 2<sup>nd</sup> Road, Zhong-Li Dist., Tao-Yuan City 32063 Taiwan (R.O.C.)  
 Phone: +886 3 433 5698  
 E-MAIL: [info@joymax.com.tw](mailto:info@joymax.com.tw)

Joymax Electronics reserves the right to make changes to the product(s) or information contained herein without notice. No liability is assumed as a result of their use or application. No rights under any patent accompany the sale of any such product(s) or information.  
 EnJOY MAX Wireless is a registered trademark of Joymax Electronics Co., Ltd. Other product and brand names may be trademarks or registered trademarks of their respective owners.  
 Copyright © 2023 Joymax Electronics  
 All Rights Reserved.

12/23 RevA