

IHX-2120ccXW

2.4 GHz ISM Whip antenna

The Joymax IHX-2120ccXW is a whip-style, low profile, monopole antenna designed for use in 2.4 GHz ISM band supporting Bluetooth®, ZigBee®, Thread®, IEEE 802.15.4, IEEE 802.11b/g and other unlicensed band application.

The antenna features ultra low profile, ideal for IoT and portable products requiring an ultra-compact, aesthetically pleasing antenna in a low profile form factor.

The monopole antenna is fully omnidirectional antenna as seen in the radiation pattern plot across all bands. Connection is made to the radio via a SMA plug (male pin) or RP-SMA plug (female socket) connector.



Features

- Bandwidth 2400 MHz to 2500 MHz
- Performance at 2400 MHz to 2500 MHz
 - VSWR: ≤ 1.6
 - Peak Gain: 3.7 dBi
 - Efficiency: 71%
- Compact size, ultra low profile ideal for small IoT products
- SMA Plug (male pin) or RP-SMA plug (female socket) connector

Applications

- 2.4 GHz ISM applications:
 - Bluetooth®
 - ZigBee®
 - Thread®
 - IEEE 802.15.4
 - IEEE 802.11b/g
- Internet of Things (IoT) devices
- Smart monitoring device
- Gateways

Ordering Information

Part Number	Description
IHX-2120SAXW	2.4GHz ISM Whip Antenna, with SMA Plug (male pin) connector
IHX-2120RSXW	2.4GHz ISM Whip Antenna, with RP-SMA Plug (female socket) connector

Available from Joymax Inc. and select distributors and representatives.

Table 1: Electrical Specifications

IHX-2120ccXW	2.4 GHz ISM (MHz)
Frequency Range	2400~2500 MHz
VSWR (Max)	1.6
Peak Gain (dBi)	3.7
Average Gain (dBi)	-1.5
Efficiency (%)	71
Polarization	Linear
Radiation	Omni directional
Max Power	1 W
Wavelength	$\frac{1}{4}\lambda$
Electrical Type	Monopole
Impedance	50 Ω

Electrical specifications and plots measured with a 120mm x 120mm (4.72 in. x 4.72 in.) reference ground plane.

Table 2: Mechanical Specifications

Parameter	Value
Connection	SMA Plug (male pin) or RP-SMA Plug (female socket)
Connector Torque	0.45 N.m Recommended; 0.7 N.m (Max.)
Weight	3.9 g
Dimension	$\varnothing 9$ mm x 22 mm (Radome $\varnothing 9$ mm x 14 mm)
Antenna Color	White
Ingress Protection	N/A
Operating Temp.	-30°C to +70°C

Packaging Information

The IHX-2120ccXW antennas are individually packaged in a clear plastic bag. **Figure 1.** 50 pcs antenna per bigger PE bag, 1000 pcs antenna per carton 330 mm x 180 mm x 180 mm (12.9 in x 7.1 in x 7.1 in), total weight 4.7 kgs (10.4 lb). Distribution channels may offer alternative packaging options.

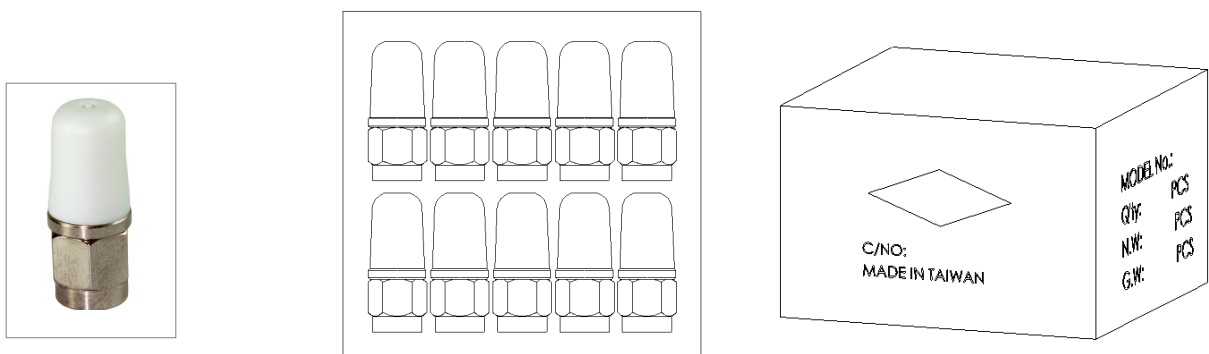

1 pce antenna/ 1 PE bag

50 pcs antenna/ 1 Bigger PE bag

1000 pcs antenna/1 Carton

Figure 1. Antenna Packaging

Product Dimensions

Figure 2 provides dimensions of the IHX-2120ccXW in mm measurement unit. Connection is made to the radio via a SMA plug (male pin), or RP-SMA plug (female socket) connector.

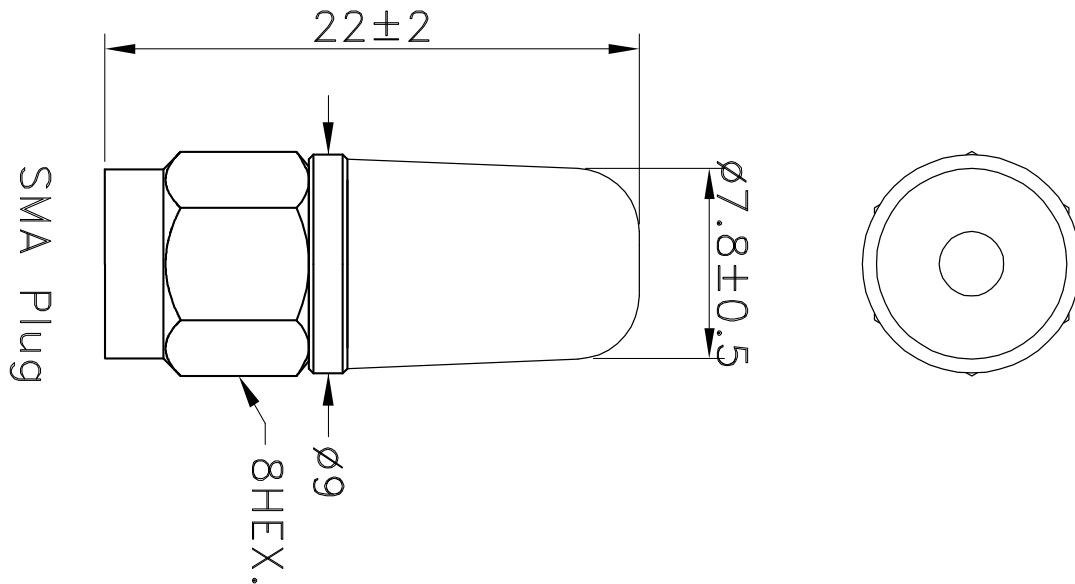

Figure 2. Antenna Dimensions

Antenna Test Setup

The IHX-2120ccXW antenna is a monopole requiring a ground plane for better performance. For reference, the antenna function is tested with an adjacent ground plane 120 mm x 120 mm (4.72 in. x 4.72 in.) as shown in **Figure 3**. The charts on the following pages represent data taken with the antenna oriented at the edge of the metal plate.

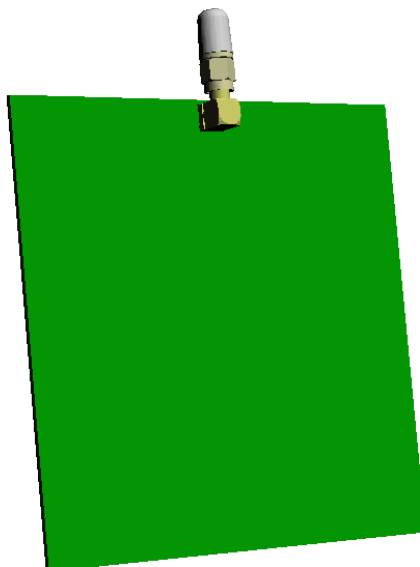

Figure 3. Antenna Test Setup

VSWR

Figure 4 provides the voltage standing wave ratio (VSWR) across the antenna bandwidth. VSWR is a function of the reflection coefficient, which describes the power reflected from the antenna back to the radio. A lower VSWR value indicates better antenna performance at a given frequency. Reflected power is also shown on the right-side vertical axis as a gauge of the percentage of transmitter power reflected back from the antenna.

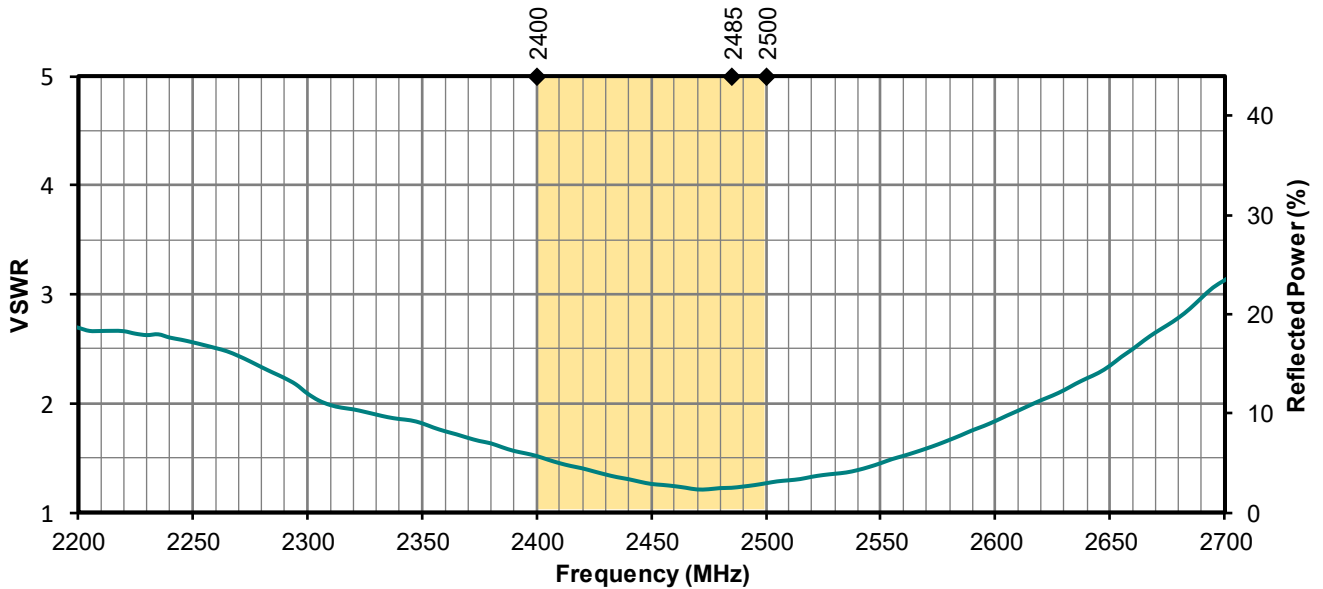

Figure 4. Antenna VSWR, with ground plane

Return Loss

Return loss (Figure 5), represents the loss in power at the antenna due to reflected signals. Like VSWR, a lower return loss value indicates better antenna performance at a given frequency.

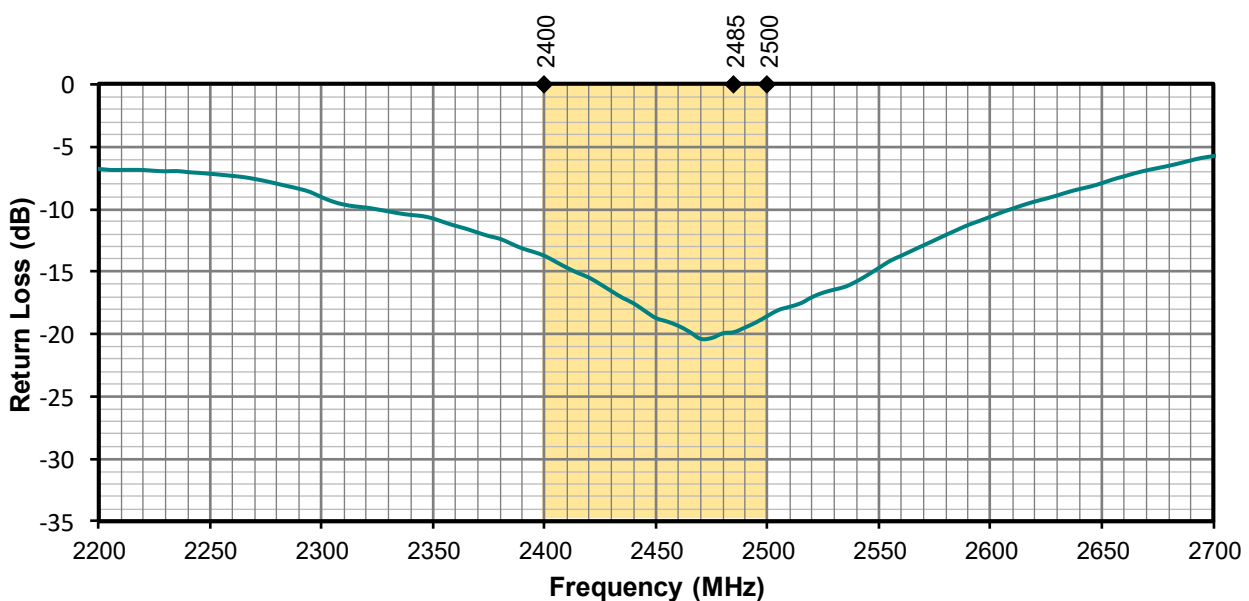

Figure 5. Antenna Return Loss, with ground plane

Peak Gain

The peak gain across the antenna bandwidth is shown in **Figure 6**. Peak gain represents the maximum antenna input power concentration across 3-dimensional space, and therefore peak performance at a given frequency, but does not consider any directionality in the gain pattern.

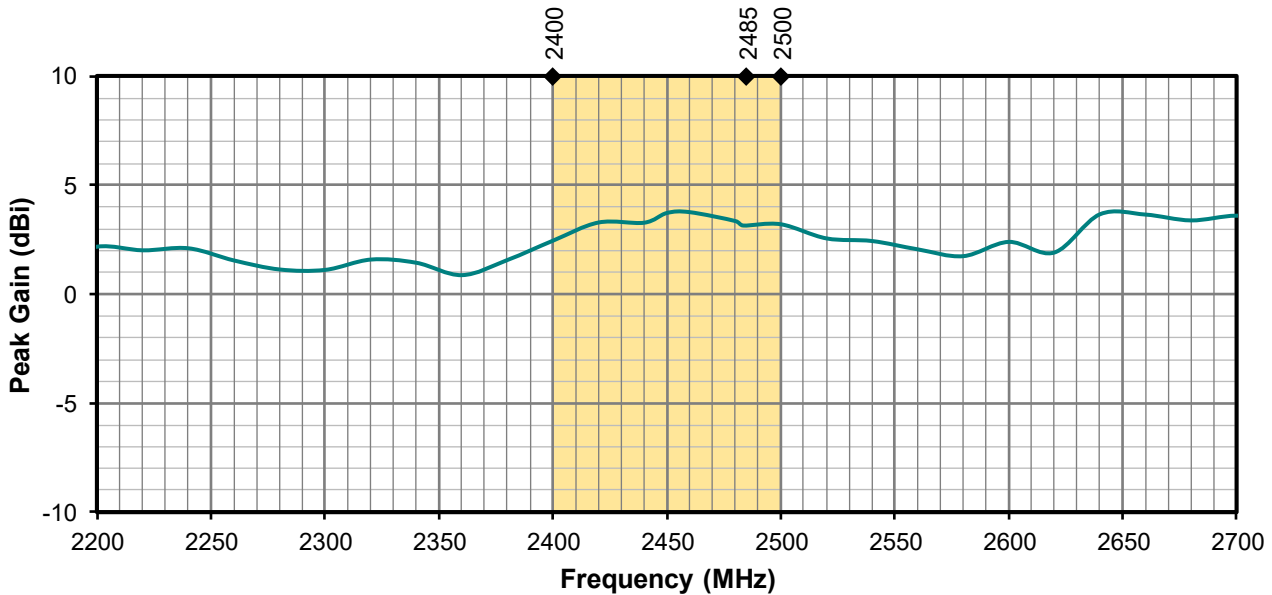

Figure 6. Antenna Peak Gain, with ground plane

Average Gain

Average gain (**Figure 7**), is the average of all antenna gain in 3-dimensional space at each frequency, providing an indication of overall performance without expressing antenna directionality.

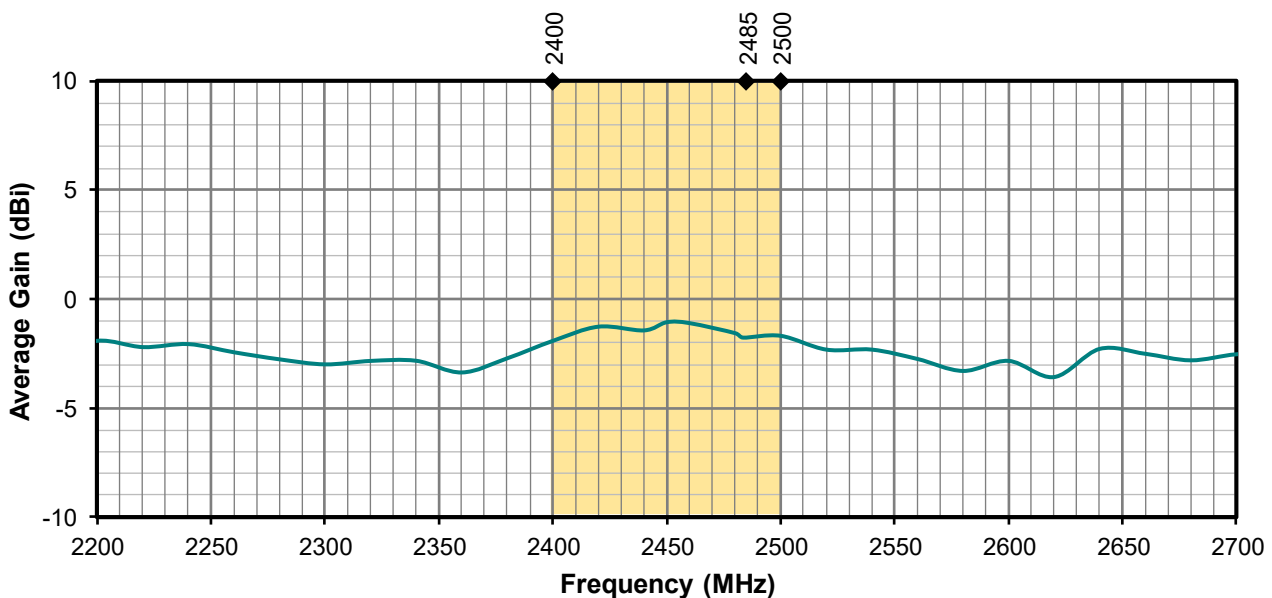

Figure 7. Antenna Average Gain, with ground plane

Radiation Efficiency

Radiation efficiency (**Figure 8**), shows the ratio of power radiated by the antenna relative to the power supplied to the antenna, expressed as a percentage, where a higher percentage indicates better performance at a given frequency. An ideal antenna has 100% efficiency. But in really world, usually an external antenna radiates only 50~60% of power supplied to it.

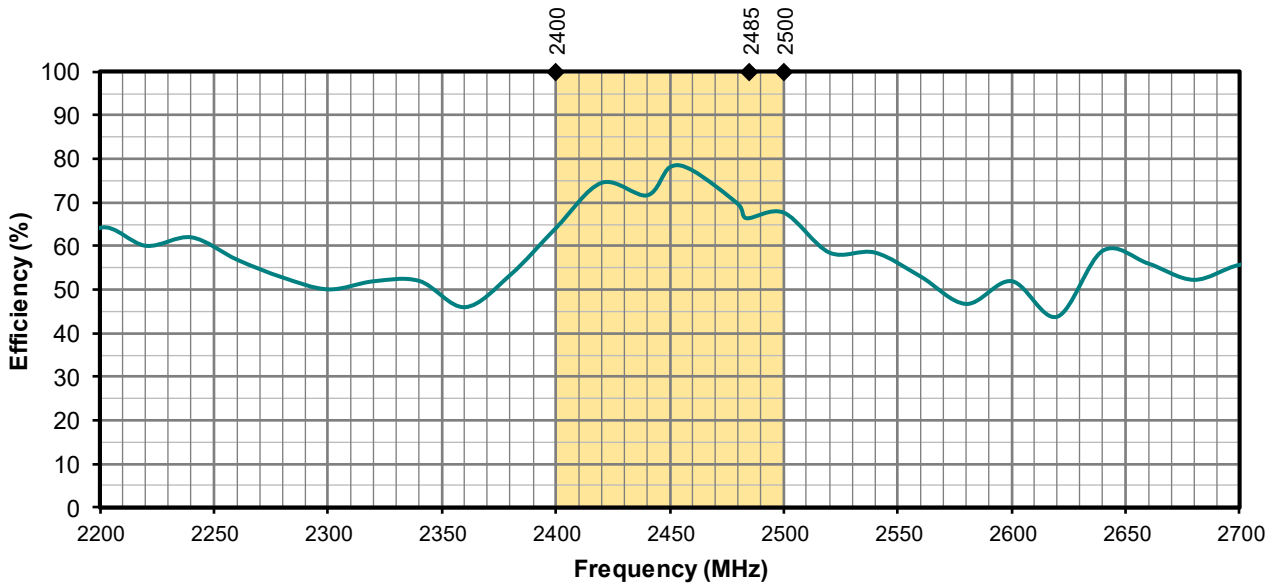
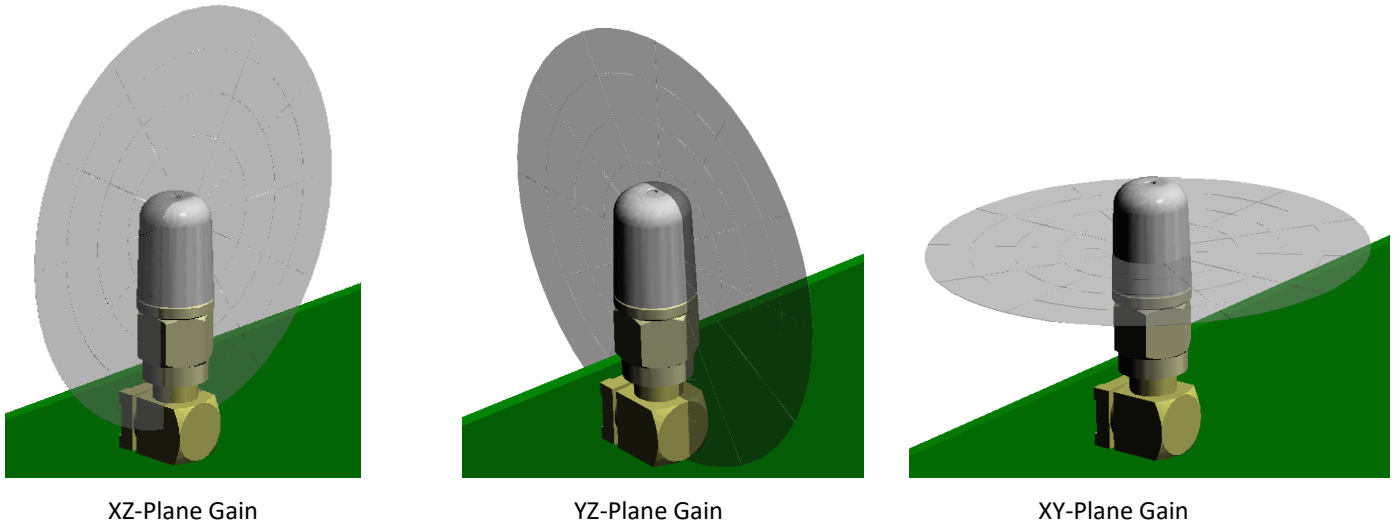

Figure 8. Antenna Efficiency, with ground plane

Radiation Patterns

Radiation patterns provide information about the directionality and 3-dimensional gain performance of the antenna by plotting gain at specific frequencies in three orthogonal planes. Antenna radiation patterns are shown in **Figure 9** using polar plots covering 360 degrees. The antenna graphic at the top of the page provides reference to the plane of the column of plots below it.



2400 MHz to 2500 MHz (2450 MHz)

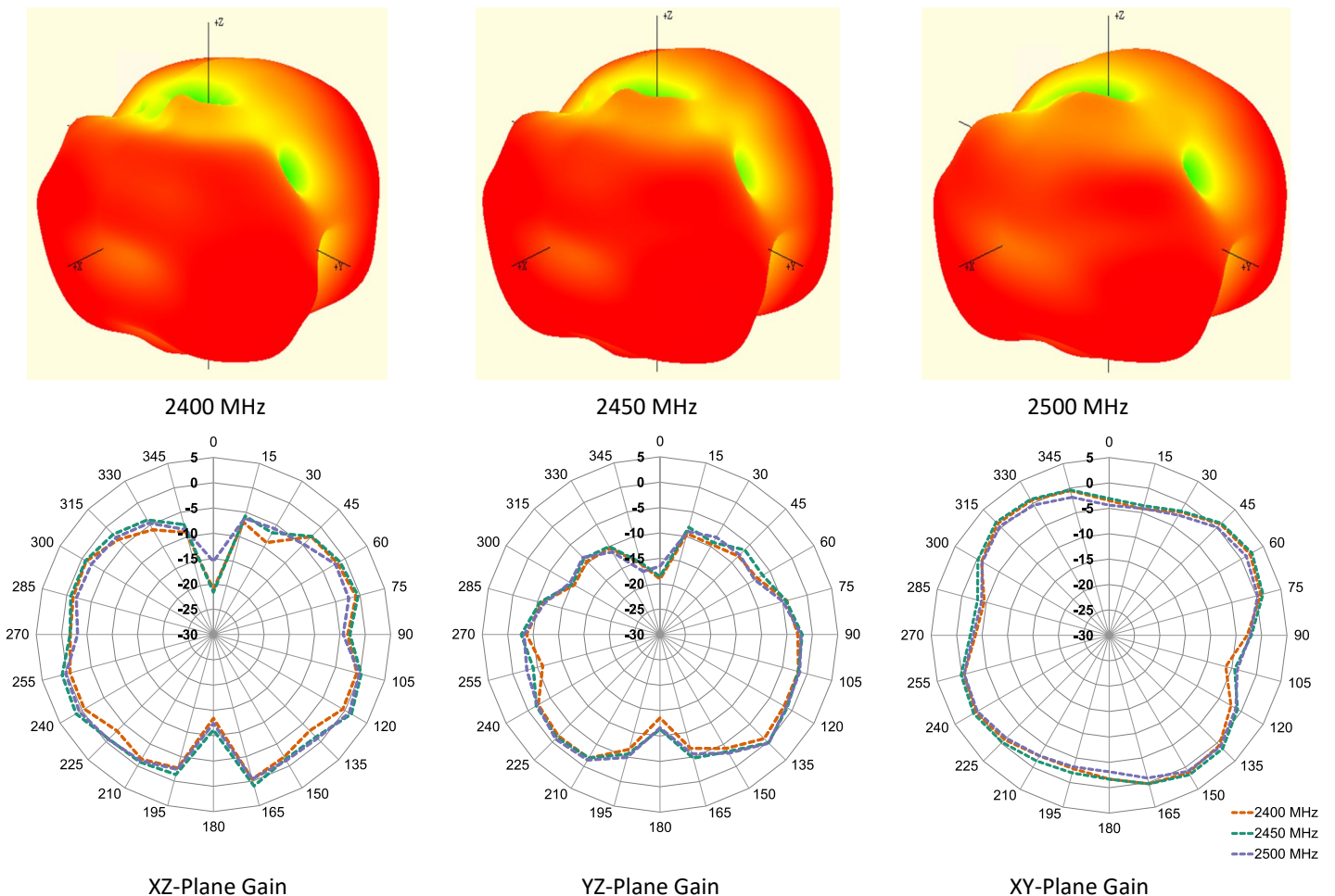

Figure 9. Antenna Radiation Patterns, with ground plane

Antenna FAQs

Q: What is an antenna?

An antenna is used for transmission or reception of radio signals in wireless communication.

Q: How do antennas work?

Electricity flowing into the transmitter antenna makes electrons vibrate up and down it, producing radio waves. The radio waves travel through the air at the speed of light. When the waves arrive at the receiver antenna, they make electrons vibrate inside it.

Q: Does antenna size matter?

A bigger antenna, properly designed, will always have more **gain** than a smaller one. And it will be the best kind of **gain**, much better than using a small antenna and simply over-amplifying it, because a small antenna just won't pull in truly weak signals like this gigantic one will.

Q: What is the advantage of external antennas?

External antennas usually offer **better bandwidth** and **high performance** due to the nature of their larger size. This often results in a higher rated **gain** (dBi) than their internal counterparts. Due to its smaller size, an internal antenna would not function well to support lower frequencies.

Ease of integration – an external antenna requires fewer design resources and shorter time to integrate to allow for a more rapid time-to-market. An internal antenna's performance is influenced by device environment – PCB ground plane, nearby metal part, and enclosure. That would require much more effort such as impedance matching network to complete antenna design.





Q: Why is most antenna impedance 50 Ohm?

50 Ohm is an industry standard of coax cables and power amplifiers. It was chosen as a tradeoff between maximum power handling for the transmit coax and the copper losses. The optimum would have been anyway in the range of **30 to 100 ohm** with average at 50 Ohm.

Q: Why does GNSS require RHCP (Right-hand-circularly-polarized) antennas?

Satellite's signal has a low power density, especially after propagating through the **atmosphere** (**ionosphere** affect radio wave). Polarized waves oscillate in more than one direction, which deliver satellite's signal to receiver on Earth surface more effectively.

MATING COMPONENTS: RF COAXIAL CONNECTOR AND CABLE ASSEMBLY

Part Number	Image	Connector 1 (Receptacle)	Connector 2 (Plug)	Cable Length		Cable Diameter (mm)
				mm	Inch	
CX-SAS0MMPA1W0007		SMA Jack Female Socket Straight	MHF1	70	2.76	1.13
CT-SAB11X-006M		SMA Jack Female Socket Right Angle	N/A	N/A	N/A	N/A
CT-SAD12X-006M		RP-SMA Jack Male Pin Straight	N/A	N/A	N/A	N/A
CT-SAD11X-006M		RP-SMA Jack Male Pin Right Angle	N/A	N/A	N/A	N/A

Website: <https://www.joymax.com.tw>

Offices: 5, Dong-Yuan 2nd Road, Zhong-Li Dist., Tao-Yuan City 32063 Taiwan (R.O.C.)

Phone: +886 3 433 5698

E-MAIL: info@joymax.com.tw

Joymax Inc. reserves the right to make changes to the product(s) or information contained herein without notice. No liability is assumed as a result of their use or application. No rights under any patent accompany the sale of any such product(s) or information.

EnJOY MAX Wireless is a registered trademark of Joymax Inc. Other product and brand names may be trademarks or registered trademarks of their respective owners.

Copyright © 2024 Joymax Inc.

All Rights Reserved.

08/24 RevA