

## IBF-H040ccXB

### 2.4 GHz Adhesive FPC antenna

The Joymax IBF-H040ccXB series antennas are adhesive-mount, flexible print circuit (FPC) board dipole antennas designed for use in 2.4 GHz ISM band supporting Bluetooth®, ZigBee®, Thread®, IEEE 802.15.4, IEEE 802.11b/g and other unlicensed band application.

The dipole antennas provide a ground plane independent internal/embedded antenna solution to easily mount in RF transparent (e.g. plastic) enclosures, enabling environmental sealing and for protection from antenna damage. Connection is made to the radio via a coaxial cable terminated in an U.FL-type / MHF plug (female socket) connector.



#### Features

- Bandwidth 2400 MHz to 2500 MHz
- Performance at 2400 MHz to 2500 MHz
  - VSWR:  $\leq 1.3$
  - Peak Gain: 3.1 dBi
  - Efficiency: 57 %
- Ground plane independence dipole design
- Compact size, low profile
- Adhesive backing permanently adheres to non-metallic enclosure/chassis using 3M 467MP

#### Applications

- 2.4 GHz ISM applications:
  - Bluetooth®
  - ZigBee®
  - Thread®
  - IEEE 802.15.4
  - IEEE 802.11b/g
- Internet of Things (IoT) devices
- Portable / Hand-held devices
- Gateways

#### Ordering Information

Part Number	Cable Diameter	Cable Length	Connector
IBF-H040MPXB-W006	1.13 mm	60 mm	U.FL-Type / MHF1 Plug
IBF-H040MPXB-W012	1.13 mm	120 mm	U.FL-Type / MHF1 Plug
IBF-H040MPXB-W018	1.13 mm	180 mm	U.FL-Type / MHF1 Plug
IBF-H040MFXB-W006	1.13 mm	60 mm	MHF4 Plug
IBF-H040MFXB-W012	1.13 mm	120 mm	MHF4 Plug
IBF-H040MFXB-W018	1.13 mm	180 mm	MHF4 Plug

Available from Joymax Electronics and select distributors and representatives.

**Table 1: Electrical Specifications**

IBF-H040ccXB	2.4 GHz ISM (MHz)
Frequency Range	2400~2500 (2450)
VSWR (Max)	1.3
Peak Gain (dBi)	3.1
Average Gain (dBi)	-2.4
Efficiency (%)	57
Polarization	Linear
Radiation	Omni directional
Max Power	1 W
Wavelength	$\frac{1}{2}\lambda$
Electrical Type	Dipole
Impedance	50 $\Omega$

Electrical specifications and plots measured with the antenna adhere to an 150 x 150 mm non-conductive plate.

**Table 2: Mechanical Specifications**

Parameter	Value
Connection	U.FL-type / MHF Plug (female socket)
Operating Temp.	-40°C to +85°C
Weight	60 mm cable—0.2 g; 120 mm cable—0.4 g; 180 mm cable—0.6 g
Dimension	40.0 mm x 7.0 mm x 0.25 mm
Antenna Color	Black
Ingress Protection	N/A

### Packaging Information

The IBF-H040ccXB antennas are bulk packaged into a clear plastic bag of 100 pcs. **Figure 1.** 2000 pcs per carton, 330 mm x 180 mm x 180 mm ( 13.0 in x 7.9 in x 7.9 in), total weight 1.5 kgs (3.3lb) Distribution channels may offer alternative packaging options.

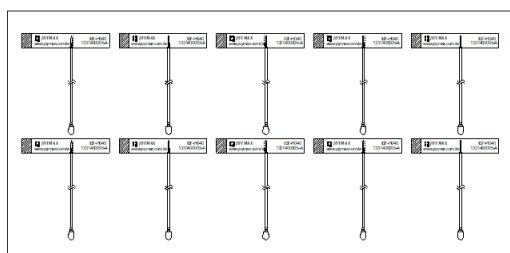

100 pcs antennas/1 Bigger PE Bag

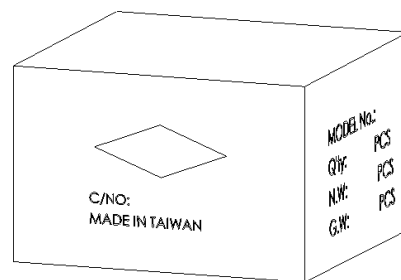

2000 pcs antenna/1 Carton

**Figure 1. Antenna Packaging**

### Product Dimensions

Figure 2 provides dimensions of the IBF-H040ccXB in mm measurement unit. The adhesive backing is 3M 467MP™, which provides outstanding adhesion to high surface energy plastics.

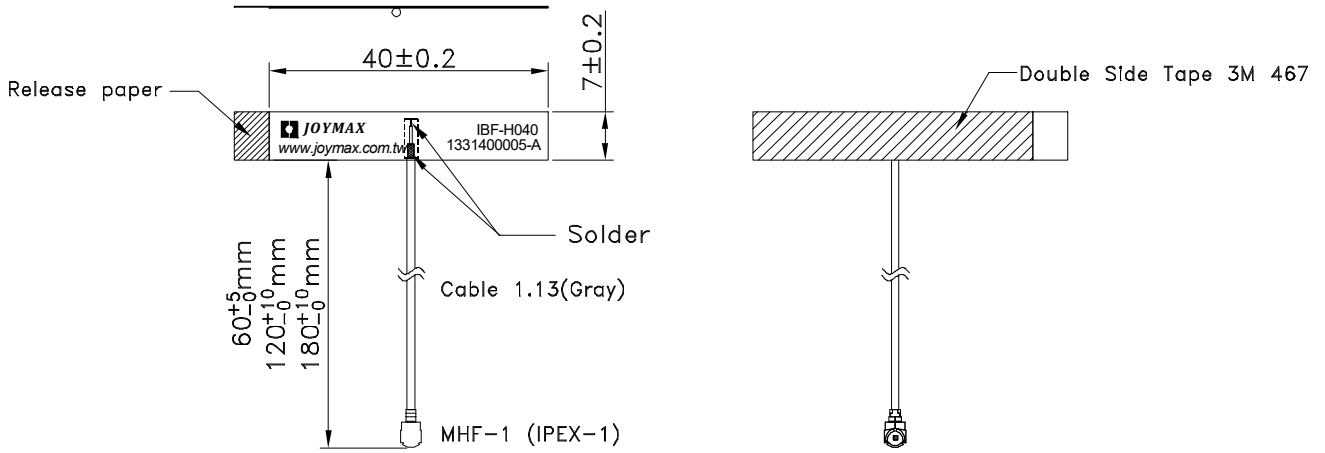

Figure 2. Antenna Dimensions

### Antenna Installation

The IBF-H040ccXB antenna is designed for chassis-mount installation as shown in Figure 3. The integration of inner mount allows the antenna to be less affected from external pressure and intensive wavering, guaranteeing the state-of-art performance through inner side enclosure installation. The antenna should never be bent to the point of creating a crease or allowing the angle of the bend to fall below 90 degrees (i.e. become acute) as this will impair function and may cause permanent damage.

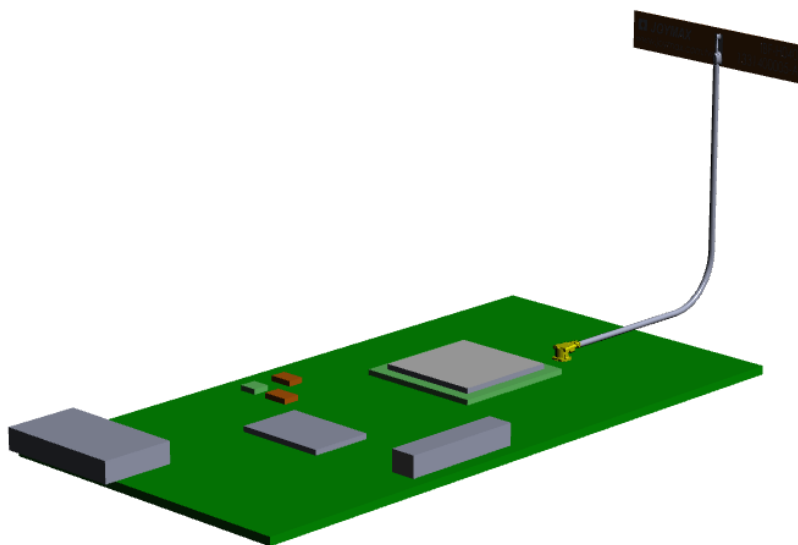
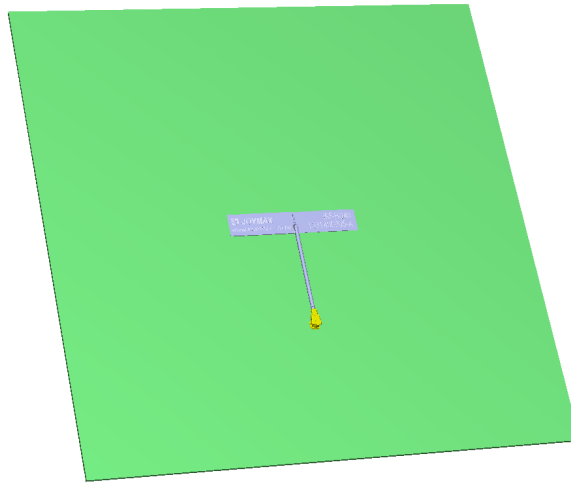

Figure 3. Antenna Installation

**Antenna Test Orientation: CHASSIS MOUNT, GROUND PLANE INDEPENDENT**

The charts on the following pages represent data taken with the antenna adhere to a 150 mm x 150 mm non-conductive plate as shown in **Figure 4**. Connection is made to the radio via a coaxial cable terminated in an U.FL-type / MHF plug (female socket) connector.



**Figure 4. Chassis Mount, ground plane independent**

**VSWR**

**Figure 5** provides the voltage standing wave ratio (VSWR) across the antenna bandwidth. VSWR is a function of the reflection coefficient, which describes the power reflected from the antenna back to the radio. A lower VSWR value indicates better antenna performance at a given frequency. Reflected power is also shown on the right-side vertical axis as a gauge of the percentage of transmitter power reflected back from the antenna.

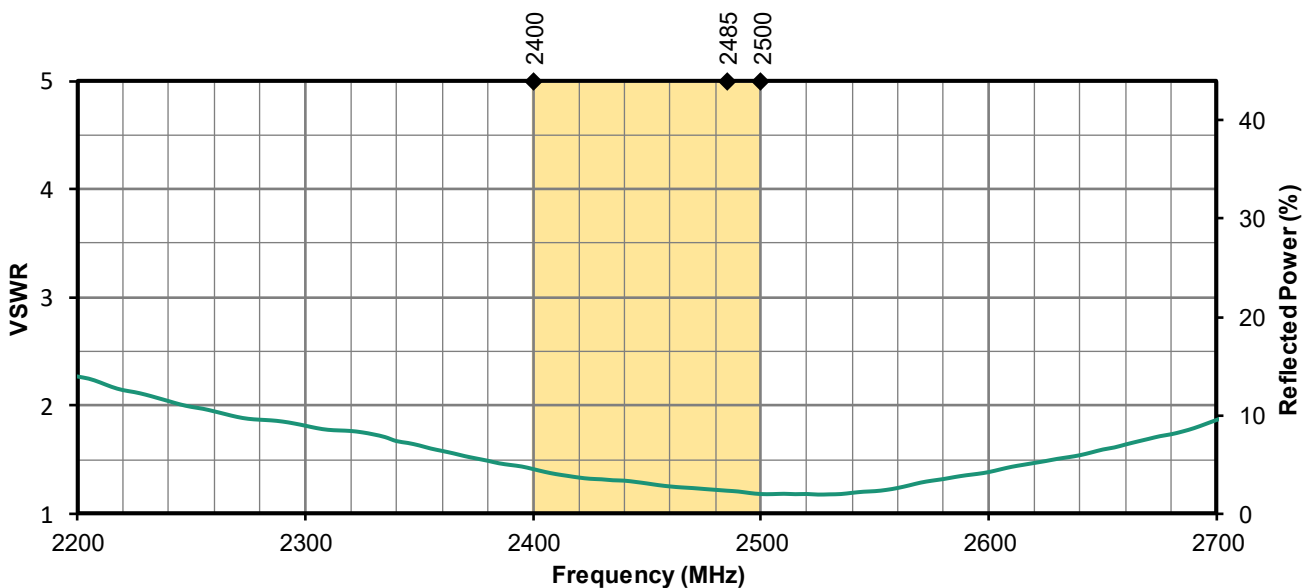

**Figure 5. Antenna VSWR, No ground plane**

### Return Loss

Return loss (**Figure 6**), represents the loss in power at the antenna due to reflected signals. Like VSWR, a lower return loss value indicates better antenna performance at a given frequency.

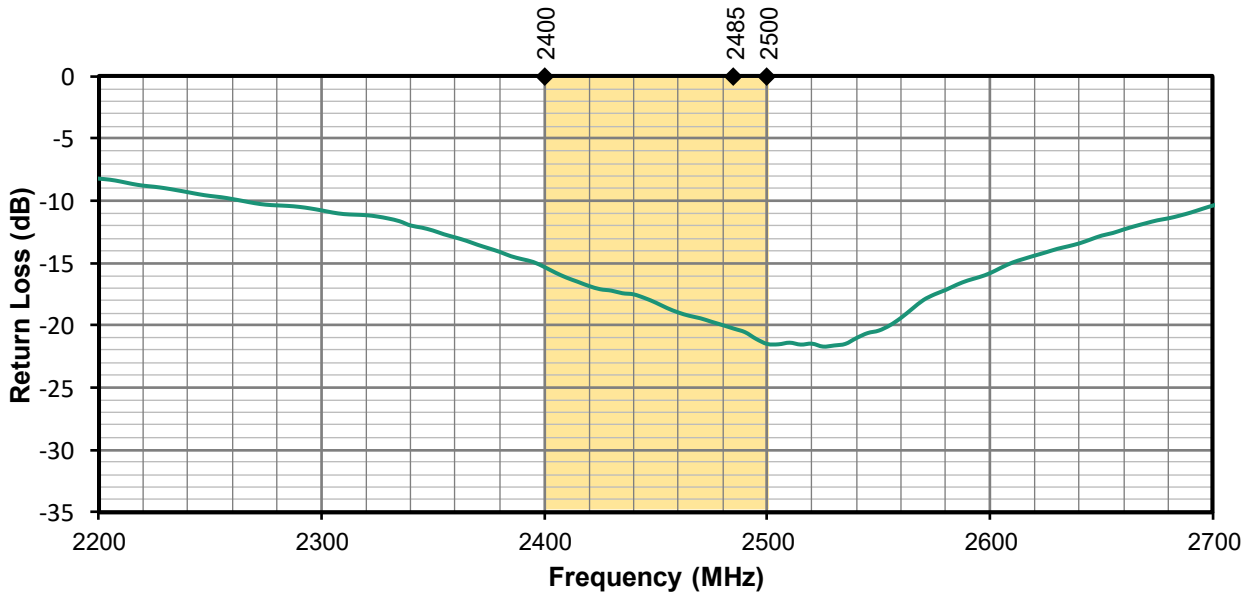

Figure 6. Antenna Return Loss, No ground plane

### Peak Gain

The peak gain across the antenna bandwidth is shown in **Figure 7**. Peak gain represents the maximum antenna input power concentration across 3-dimensional space, and therefore peak performance at a given frequency, but does not consider any directionality in the gain pattern.

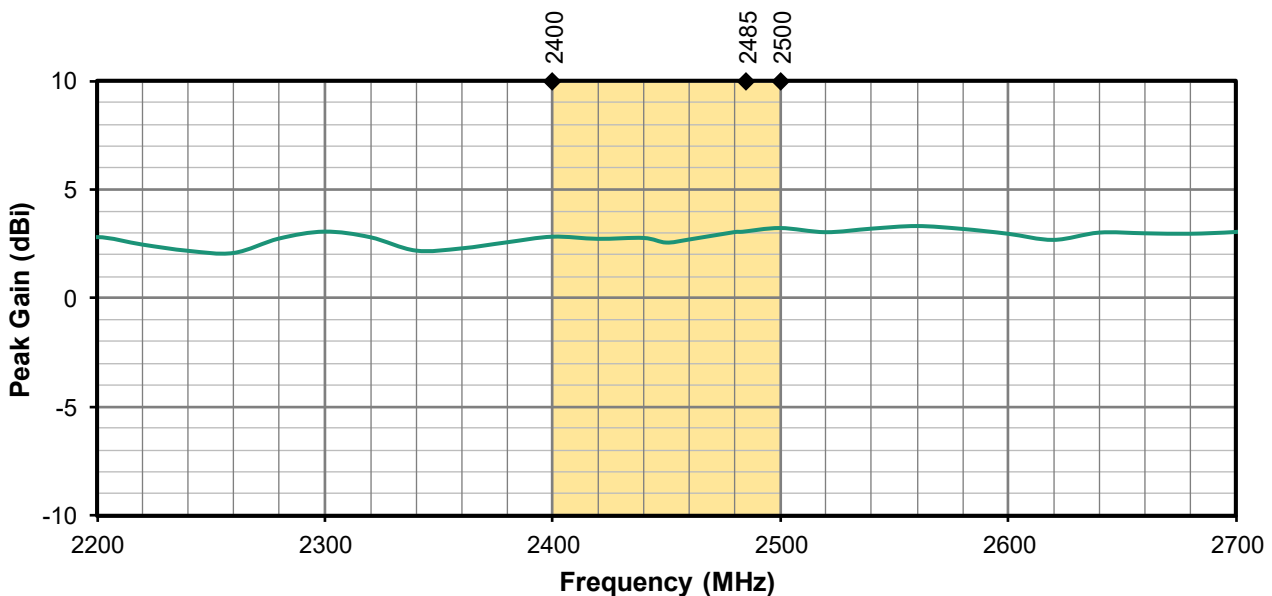

Figure 7. Antenna Peak Gain, No ground plane

### Average Gain

Average gain (**Figure 8**), is the average of all antenna gain in 3-dimensional space at each frequency, providing an indication of overall performance without expressing antenna directionality.

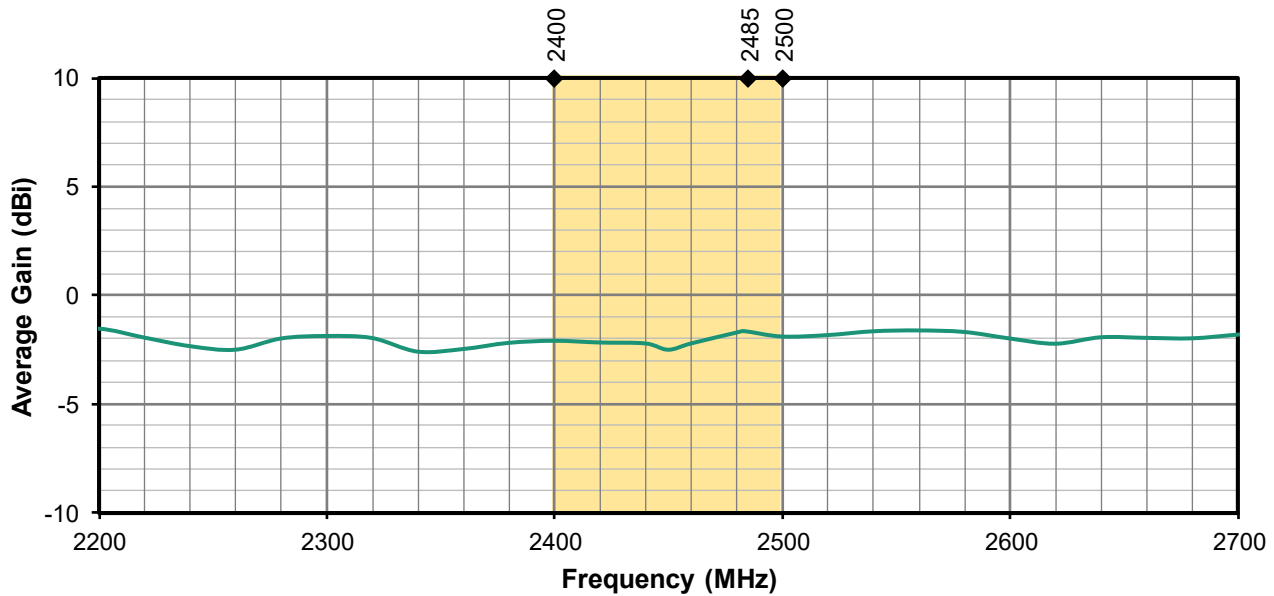

Figure 8. Antenna Average Gain, No ground plane

### Radiation Efficiency

Radiation efficiency (**Figure 9**), shows the ratio of power radiated by the antenna relative to the power supplied to the antenna, expressed as a percentage, where a higher percentage indicates better performance at a given frequency. An ideal antenna has 100% efficiency. But in really world, usually an external antenna radiates only 50~60% of power supplied to it.

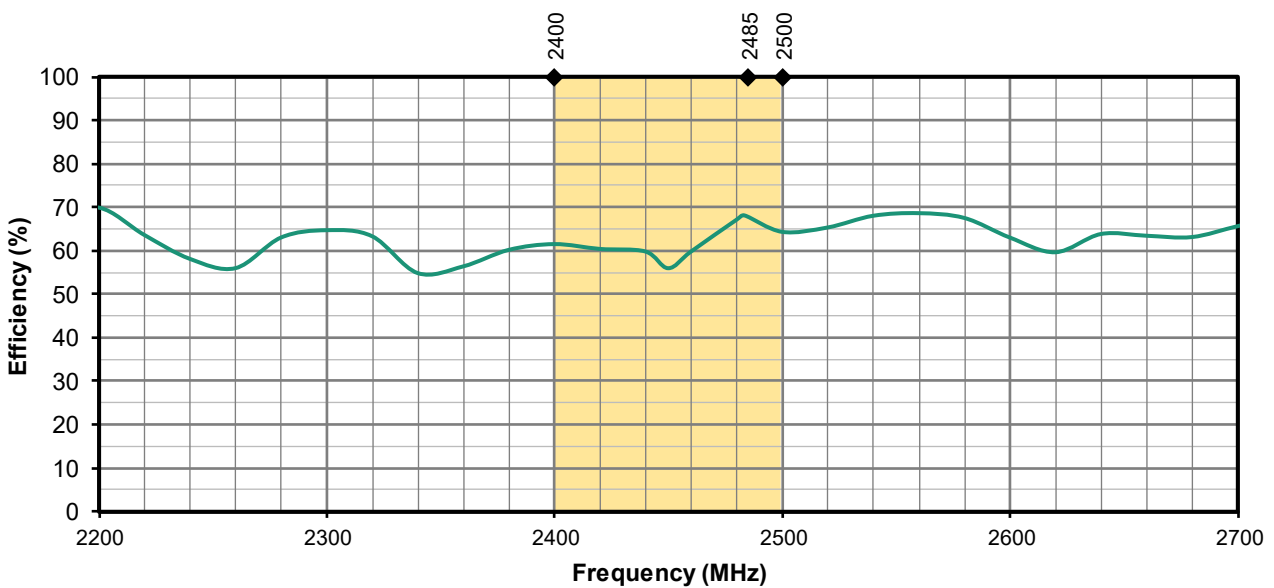
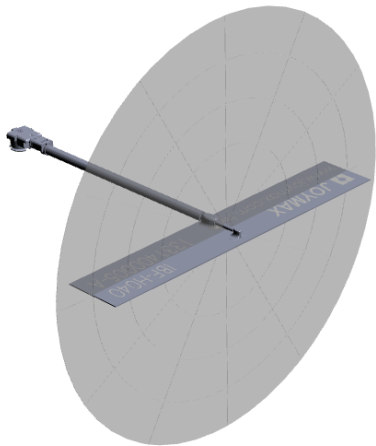

Figure 9. Antenna Efficiency, No ground plane

### Radiation Patterns

Radiation patterns provide information about the directionality and 3-dimensional gain performance of the antenna by plotting gain at specific frequencies in three orthogonal planes. Antenna radiation patterns for a straight orientation are shown in **Figure 10** using polar plots covering 360 degrees. The antenna graphic at the top of the page provides reference to the plane of the column of plots below it.



XZ-Plane Gain

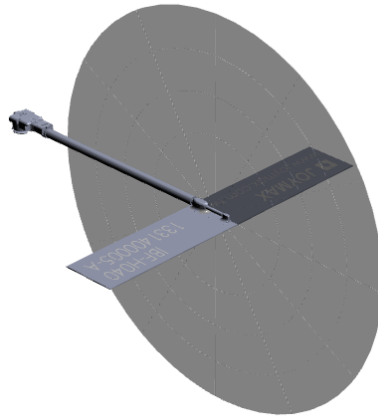

YZ-Plane Gain

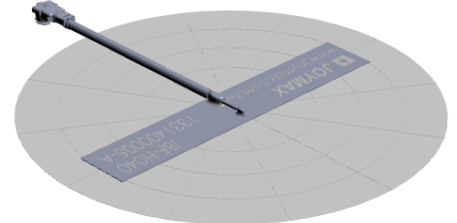

XY-Plane Gain

### 2400 MHz to 2500 MHz (2450 MHz)

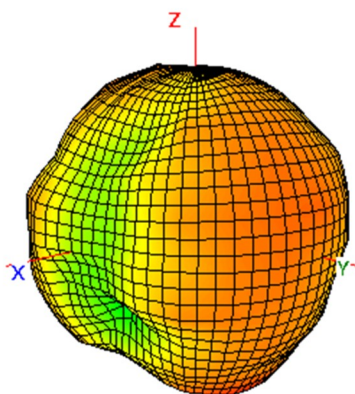

2400 MHz

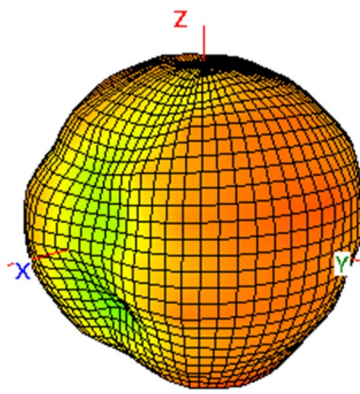

2450 MHz

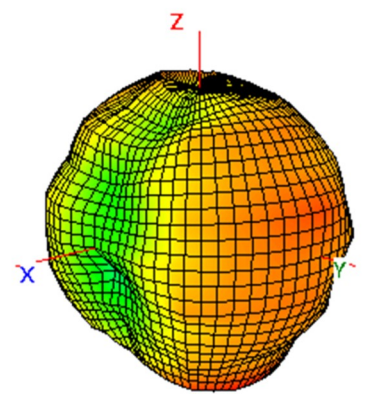

2500 MHz

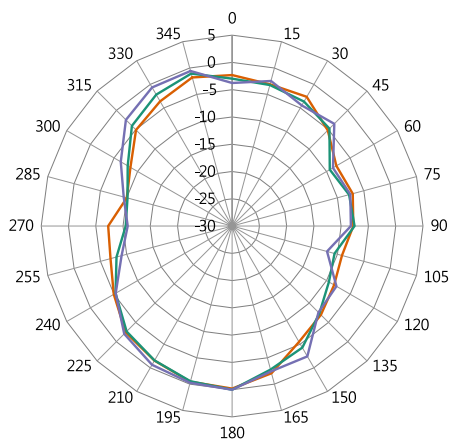

XZ-Plane Gain

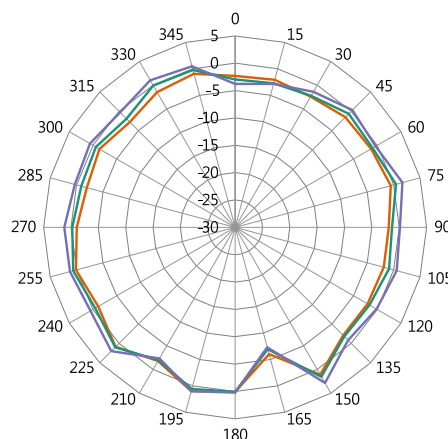

YZ-Plane Gain

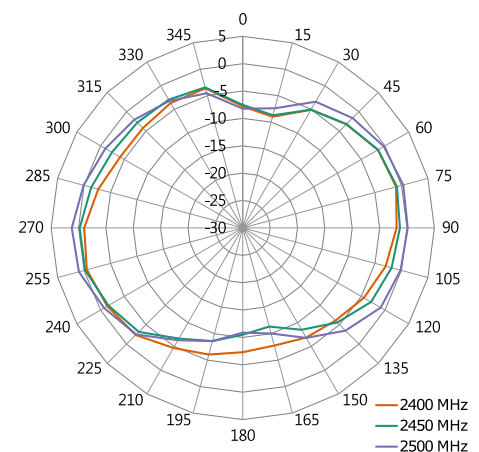

XY-Plane Gain

Figure 10. Antenna Radiation Patterns, No ground plane

## Antenna FAQs

### Q: What is an antenna?

An antenna is used for transmission or reception of radio signals in wireless communication.

### Q: How do antennas work?

Electricity flowing into the transmitter antenna makes electrons vibrate up and down it, producing radio waves. The radio waves travel through the air at the speed of light. When the waves arrive at the receiver antenna, they make electrons vibrate inside it.

### Q: Does antenna size matter?

A bigger antenna, properly designed, will always have more **gain** than a smaller one. And it will be the best kind of **gain**, much better than using a small antenna and simply over-amplifying it, because a small antenna just won't pull in truly weak signals like this gigantic one will.

### Q: What is the advantage of external antennas?

External antennas usually offer **better bandwidth** and **high performance** due to the nature of their larger size. This often results in a higher rated **gain** (dBi) than their internal counterparts. Due to its smaller size, an internal antenna would not function well to support lower frequencies.

Ease of integration – an external antenna requires fewer design resources and shorter time to integrate to allow for a more rapid time-to-market. An internal antenna's performance is influenced by device environment – PCB ground plane, nearby metal part, and enclosure. That would require much more effort such as impedance matching network to complete antenna design.



### Q: Why is most antenna impedance 50 Ohm?

50 Ohm is an industry standard of coax cables and power amplifiers. It was chosen as a tradeoff between maximum power handling for the transmit coax and the copper losses. The optimum would have been anyway in the range of **30 to 100 ohm** with average at 50 Ohm.

### Q: Why does GNSS require RHCP (Right-hand-circularly-polarized) antennas?

Satellite's signal has a low power density, especially after propagating through the **atmosphere** (**ionosphere** affect radio wave). Polarized waves oscillate in more than one direction, which deliver satellite's signal to receiver on Earth surface more effectively.

## MATING COMPONENTS: RF COAXIAL CONNECTOR

Part Number	Image	Connector 1 (Receptacle)	Connector 2 (Plug)	Cable Length		Cable Diameter (mm)
				mm	Inch	
<a href="#">CT-MFB01X</a>		MHF4L Jack Male pin Straight	N/A	N/A	N/A	N/A
<a href="#">CT-MPB01X</a>		MHF1 Jack Male pin Straight	N/A	N/A	N/A	N/A

Website: <https://www.joymax.com.tw>

Offices: 5, Dong-Yuan 2<sup>nd</sup> Road, Zhong-Li Dist., Tao-Yuan City 32063 Taiwan (R.O.C.)

Phone: +886 3 433 5698

E-MAIL: [info@joymax.com.tw](mailto:info@joymax.com.tw)

Joymax Electronics reserves the right to make changes to the product(s) or information contained herein without notice. No liability is assumed as a result of their use or application. No rights under any patent accompany the sale of any such product(s) or information.

EnJOY MAX Wireless is a registered trademark of Joymax Electronics Co., Ltd. Other product and brand names may be trademarks or registered trademarks of their respective owners.

Copyright © 2024 Joymax Electronics  
All Rights Reserved.

01/24 RevA