

**SERIES:** TJ-150 | **DESCRIPTION:** AC-DC POWER SUPPLY**FEATURES**

- 150 W continuous output power
- universal input (90~264 Vac)
- -40 ~ 90 °C operating range with derating
- ultra-low profile (19.7 mm)
- UL/EN/IEC 62368-1 certified
- Class B emissions; no external components required
- over temperature, over voltage, over current, and short circuit protections
- safety Class I
- operating altitude 5,000 meters
- encapsulated, heatsink or baseplate cooling



MODEL	output voltage	output current	output power <sup>1</sup>	ripple and noise <sup>2</sup>	efficiency
	(Vdc)	max (A)	max (W)	max (mVp-p)	typ (%)
TJ-150-12	12	12.5	150	120	91
TJ-150-24	24	6.25	150	240	92
TJ-150-28	28	5.35	150	280	93
TJ-150-36	36	4.16	150	360	93
TJ-150-48	48	3.125	150	480	93
TJ-150-54	54	2.77	150	540	92

Notes: 1. Ripple & noise are measured at 20 MHz BW with 0.1  $\mu$ F ceramic capacitor and a 10  $\mu$ F electrolytic capacitors.  
 2. At 230 Vac, full load, 25°C.

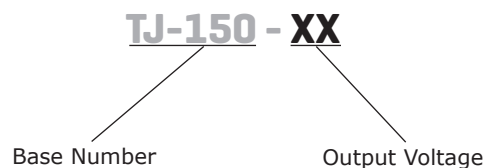
**PART NUMBER KEY**

## INPUT

parameter	conditions/description	min	typ	max	units
voltage		90		264	Vac
		120		370	Vdc
frequency		47		63	Hz
input current	at 100 Vac, full load			2	A
inrush current	at 240 Vac, cold start			100	A
leakage current				0.75	mA
power factor	at 230 Vac /50 Hz, full load	0.92			
under voltage protection		65	70	75	Vac
no load power consumption				0.5	W

## OUTPUT

parameter	conditions/description	min	typ	max	units
capacitive load	at 115 Vac and 230 Vac input, full load, 25 °C				
	12 Vdc output model			13,500	µF
	24 Vdc output model			6,600	µF
	28 Vdc output model			5,600	µF
	38 Vdc output model			4,400	µF
	48 Vdc output model			3,380	µF
line regulation	high line to low line			±0.5	%
				±1.0	%
load regulation	10% load to full load			±1.0	%
initial set point accuracy	12 Vdc output model		+1.0/-1.7		%
	all other output models		+1.0/-1.0		%
initial set point	at 90 Vac ~ 264 Vac input, full load, 25 °C				
	12 Vdc output model	11.8	12	12.12	Vdc
	24 Vdc output model	23.76	24	24.24	Vdc
	28 Vdc output model	27.72	28	28.28	Vdc
	38 Vdc output model	35.64	36	36.36	Vdc
	48 Vdc output model	47.52	48	48.48	Vdc
54 Vdc output model	53.46	54	54.54	Vdc	
hold-up time	at 115 Vac, full load	10			ms
switching frequency			180		kHz
trim			5		%

## PROTECTIONS

parameter	conditions/description	min	typ	max	units
over voltage protection	12 Vdc output model, auto recovery			13.8	Vdc
	24 Vdc output model, auto recovery			27	Vdc
	28 Vdc output model, auto recovery			32.3	Vdc
	38 Vdc output model, auto recovery			41.7	Vdc
	48 Vdc output model, auto recovery			53.3	Vdc
	54 Vdc output model, latch off			57.6	Vdc
over current protection	hiccup, auto recovery	110	130	150	%
short circuit protection	auto recovery				
over temperature protection	auto recovery				

## SAFETY & COMPLIANCE

parameter	conditions/description	min	typ	max	units
isolation voltage	input to output for 1 minute (without dielectric breakdown)			3,000	Vac
	input to ground for 1 minute (without dielectric breakdown)			1,800	Vac
	output to ground for 1 minute (without dielectric breakdown)			1,800	Vac
safety approvals	certified to 62368-1: IEC, EN, UL				
EMI/EMC	EN 55032: 2015+A11: 2020, EN 61000-6-3: 2007+A1: 2011+AC: 2012, EN 61000-6-4: 2019, EN 61204-3: 2018, EN 61000-3-2:2019, EN 61000-3-3: 2013+A1: 2019, 47 CFR FCC Part 15 Subpart B				
conducted emissions	EN 55032: 2015+A11: 2020, 47 CFR FCC Part 15 Subpart B, Class B				
radiated emissions	EN 55032: 2015+A11: 2020, 47 CFR FCC Part 15 Subpart B, Class B				
ESD	IEC 61000-4-2:2008 Air Discharge: ±8kV, Contact Discharge: ±4kV, perf. Criteria A				
radiated immunity	IEC 61000-4-3:2020, perf. Criteria A				
EFT/Burst	IEC 61000-4-4:2012, ±2kV, perf. Criteria A				
surge	IEC 61000-4-5:2014+A1: 2017, L-N: ±1kV, L-E(Ground): ±2kV, perf. Criteria A				
conducted immunity	IEC 61000-4-6:2013+COR1: 2015, perf. Criteria A				
voltage dips	IEC 61000-4-11:2020, Dip: 30% Reduction, Dip >95% Reduction perf. Criteria A				
power frequency magnetic field	IEC 61000-4-8:2009, perf. Criteria A				
voltage interruptions	IEC 61000-4-11:2020, >95% Reduction perf. Criteria B				
class	class I				
MTBF	as per MIL-HDBK-217F at 40 °C, Io = 75%	350,000			hours
life time	75% load, 40 °C	72,000			hours

## ENVIRONMENTAL

parameter	conditions/description	min	typ	max	units
operating case temperature	at the centre of base plate	-40		90	°C
storage temperature		-40		100	°C
operating humidity	non-condensing	-		93	%
operating altitude				5,000	m
shock	10 ms along each of the X, Y, and Z axes 3 times		75		g
vibration	15 ~ 2,000Hz for 1 hour along each of the X, Y, and Z axes		4		g
heatsink thermal impedance	LFM			Rca	°C/W

## DERATING CURVES

**TEMPERATURE DERATING CURVE  
(with heatsink 116.8x61x25.4mm)**

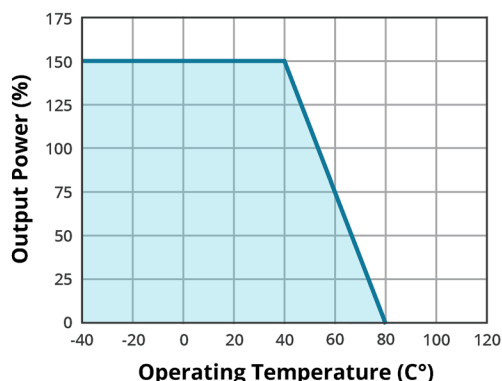

**TEMPERATURE DERATING CURVE  
(with baseplate 254 x 254 x 2 mm)**

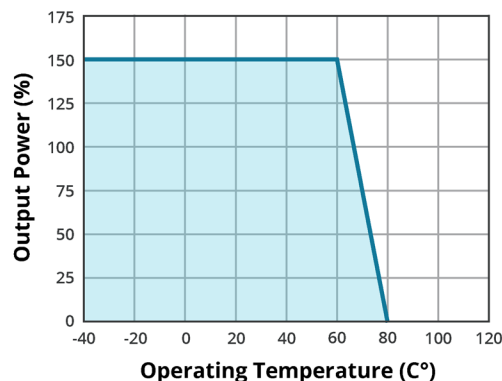

## DERATING CURVES (CONTINUED)

**CASE TEMPERATURE ( $T_c$ )  
DERATING CURVE**

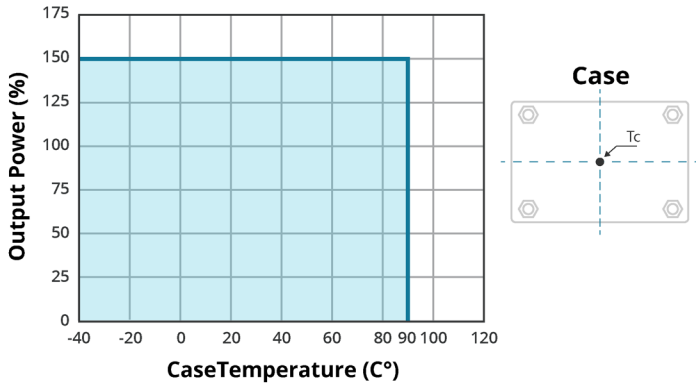

## EFFICIENCY CURVES

**EFFICIENCY VS OUTPUT LOAD  
TJ-150-12**

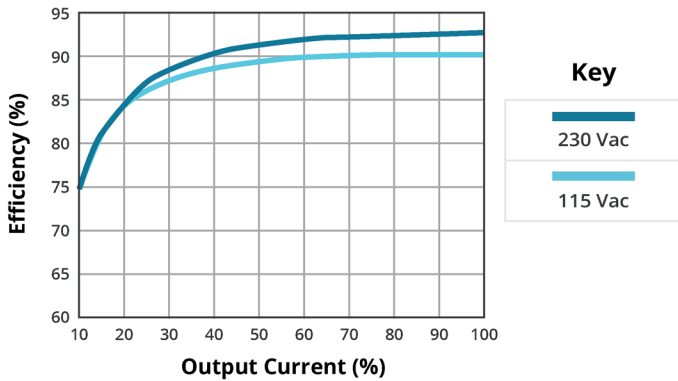

**EFFICIENCY VS OUTPUT LOAD  
TJ-150-24**

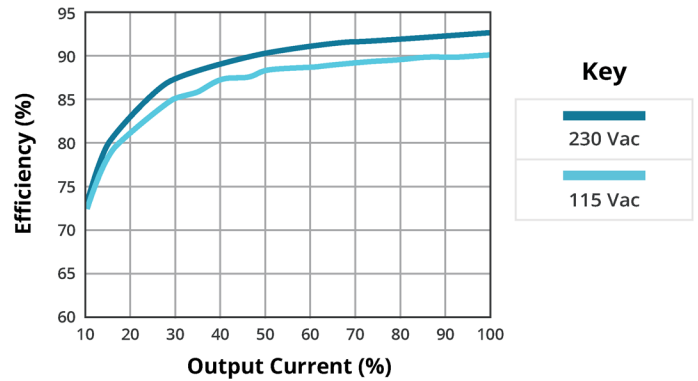

**EFFICIENCY VS OUTPUT LOAD  
TJ-150-28**

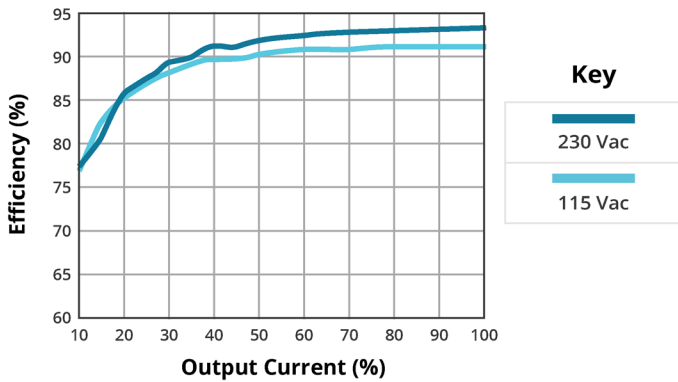

**EFFICIENCY VS OUTPUT LOAD  
TJ-150-36**

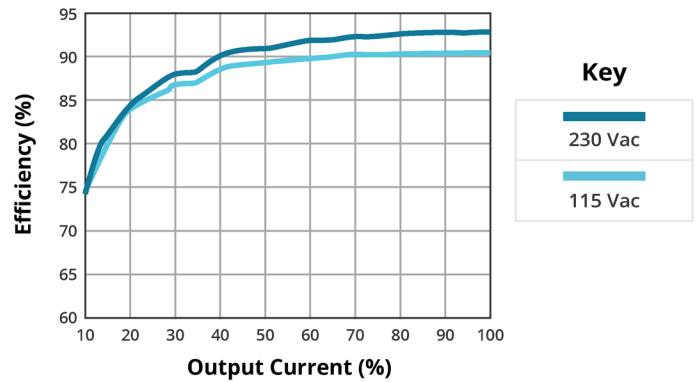

## EFFICIENCY CURVES (CONTINUED)

**EFFICIENCY VS OUTPUT LOAD  
TJ-150-48**

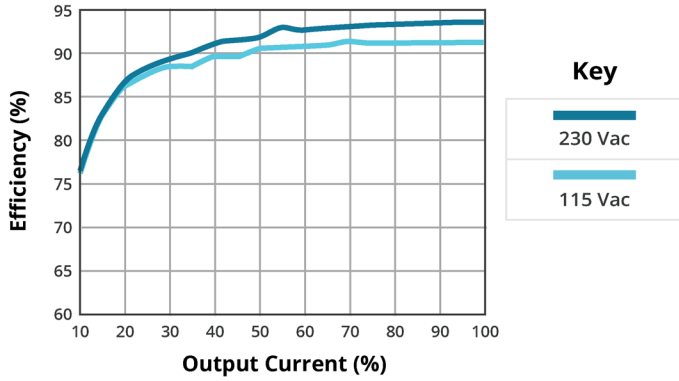

**EFFICIENCY VS OUTPUT LOAD  
TJ-150-54**

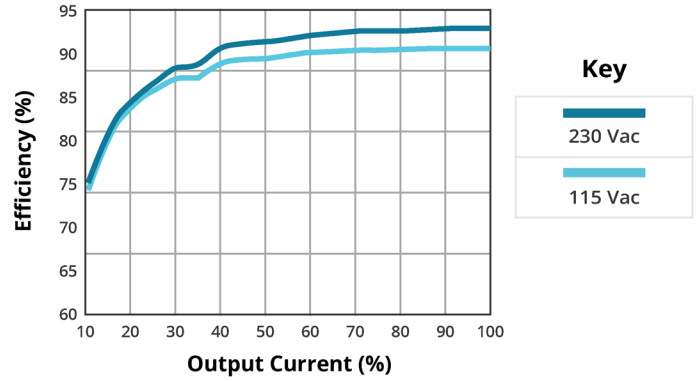

**POWER DERATING & AIRFLOW  
(without heatsink)**

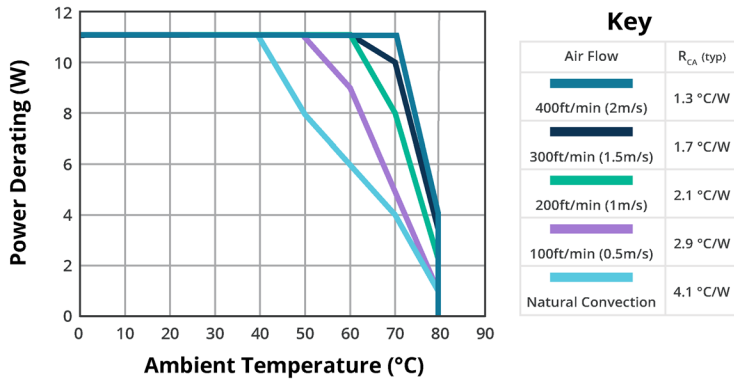

**POWER DERATING & AIRFLOW  
(with heatsink 116.8 x 61 x 25.4mm)**

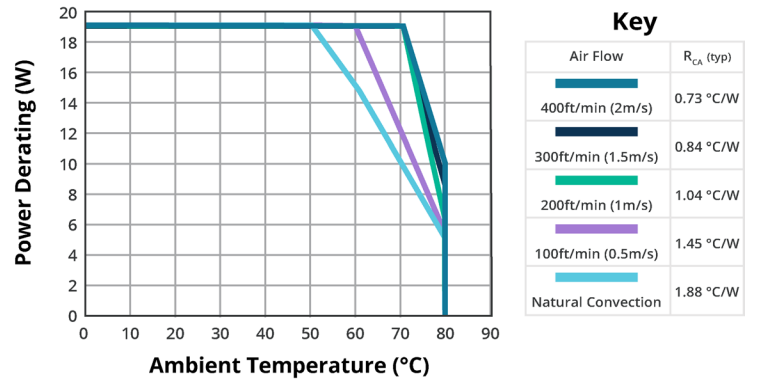

## MECHANICAL

parameter	conditions/description	min	typ	max	units
dimensions	4.60 x 2.40 x 0.78 [116.8 x 61.0 x 19.7 mm]				inch
weight			285		g

## MECHANICAL DRAWING

units: inch [mm]

tolerance: inches: x.xx = ±0.02, x.xxx = ±0.020

mm: x.x = ±0.5, x.xx = ±0.50

PIN CONNECTIONS	
1	AC(L)
2	AC(N)
3	FG
4	+Sense
5	+Vout
6	Trim
7	-Vout
8	-Sense

Note: The thermal plate and mounting holes are electrically connected to the FG pin.

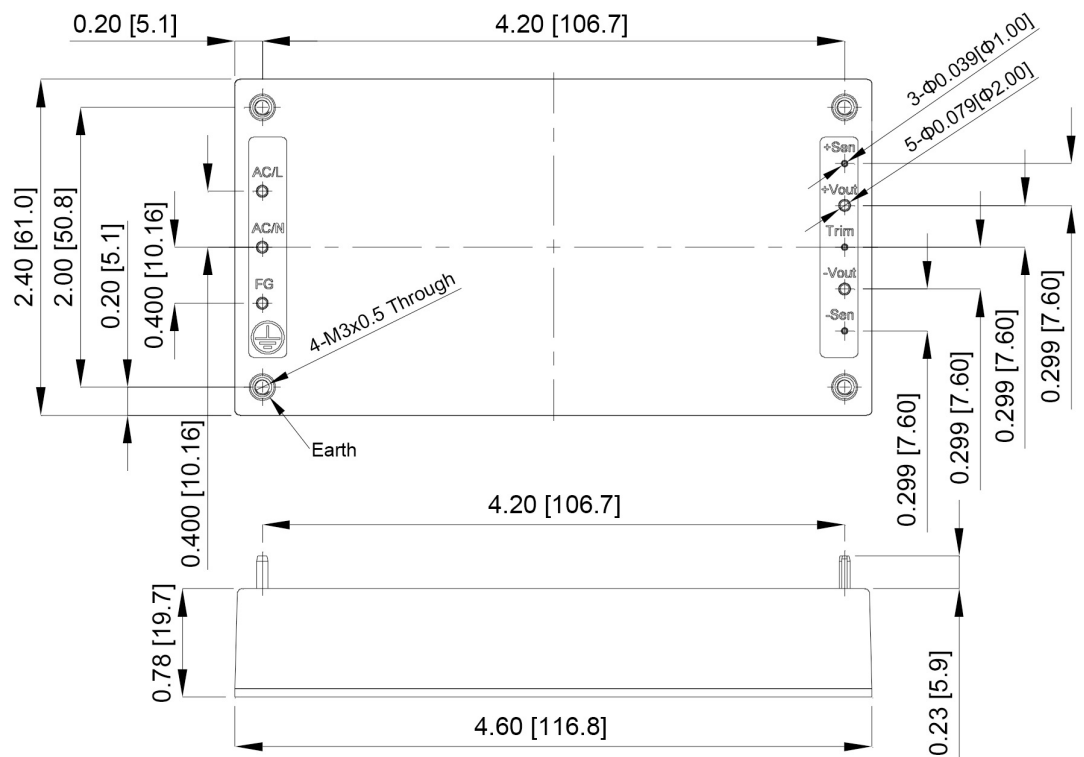

## ELECTRICAL BLOCK DIAGRAM

Figure 1

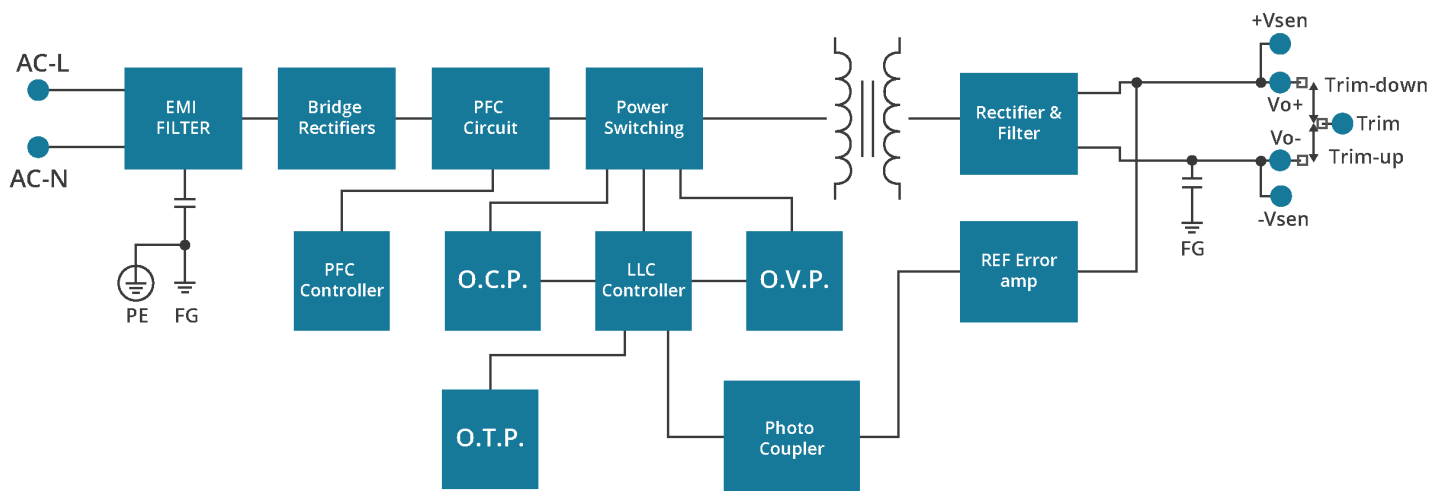

## APPLICATION NOTES

Figure 2

Trim up

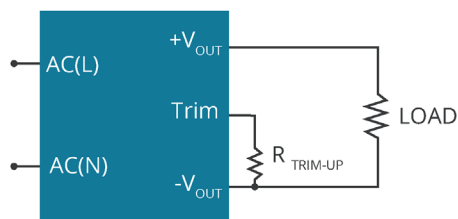

$$R_{TRIM} = \left( \frac{V_{REF} \times (R_{TOP} + R_{BOTTOM}) \times R_O}{V_O \times R_O - V_{REF} \times (R_{TOP} + R_{BOTTOM}) - V_{REF} \times R_O} \right) - R_{TRIM} \text{ (K}\Omega\text{)}$$

Formula for Trim up

Trim down

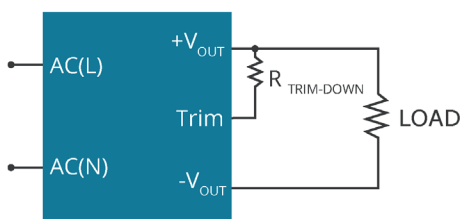

$$R_{TRIM} = \left( \frac{V_O \times R_O \times (R_{TOP} + R_{BOTTOM}) - V_{REF} \times R_O \times (R_{TOP} + R_{BOTTOM})}{V_{REF} \times (R_{TOP} + R_{BOTTOM}) - V_O \times R_O + V_{REF} \times R_O} \right) - R_{TRIM} \text{ (K}\Omega\text{)}$$

Formula for Trim down

Table 1

V <sub>NOM</sub>	R <sub>TOP</sub>	R <sub>BOTTOM</sub>	R <sub>O</sub>	R <sub>TRIM</sub>	V <sub>REF</sub>
(V)	(kΩ)	(kΩ)	(kΩ)	(kΩ)	(V)
12	11.5	7.87	5.1	1	2.5
24	36.0	7.87	5.1	1	2.5
28	47.0	4.99	5.1	1	2.5
36	53.6	14.7	5.1	1	2.5
48	82.5	10.0	5.1	1	2.5
54	100.0	4.75	5.1	1	2.5

Note: Value for R<sub>TOP</sub>, R<sub>BOTTOM</sub>, R<sub>O</sub>, and V<sub>REF</sub> refer to Table 1 (fixed internal values).

R<sub>TRIM</sub>: Trim resistance

V<sub>NOM</sub>: Nominal output voltage

## REVISION HISTORY

---

rev.	description	date
1.0	initial release	09/05/2024

The revision history provided is for informational purposes only and is believed to be accurate.



**CUI INC**

a bel group

**Headquarters**

15575 SW Sequoia Pkwy #100 Fax 503.612.2383  
Portland, OR 97224 [cui.com](http://cui.com)

**800.275.4899**

[techsupport@cui.com](mailto:techsupport@cui.com)

CUI offers a two (2) year limited warranty. Complete warranty information is listed on our website.

CUI reserves the right to make changes to the product at any time without notice. Information provided by CUI is believed to be accurate and reliable. However, no responsibility is assumed by CUI for its use, nor for any infringements of patents or other rights of third parties which may result from its use.

CUI products are not authorized or warranted for use as critical components in equipment that requires an extremely high level of reliability. A critical component is any component of a life support device or system whose failure to perform can be reasonably expected to cause the failure of the life support device or system, or to affect its safety or effectiveness.