



Quality Products. Service Excellence.

Audio Chassis Mount 143-146 Series

Features



- Small, economical, open, two hole horizontal bracket mount.
- Insulated, color coded flexible leads, 4" long minimum (143, 144 & 145 Series) or 3" long minimum (146 Series).
- For a similar version designed to be PC Board mounted, refer to the **148** and **149** series.
- Frequency response 150 Hz. to 15 KHz. (+/- 1 db, reference 1000 Hz.)
- When operating at impedances below nominal, power capability and the frequency spectrum are proportionately lower; conversely, at higher impedances power capability and frequency spectrum will be proportionately higher.
- Net weight: 0.5 oz. (143, 144, 146 Series) & 1.4 oz. (145 Series).



ASK ABOUT
Custom
Transformers
& Chokes

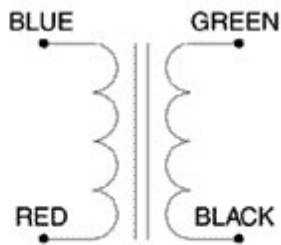
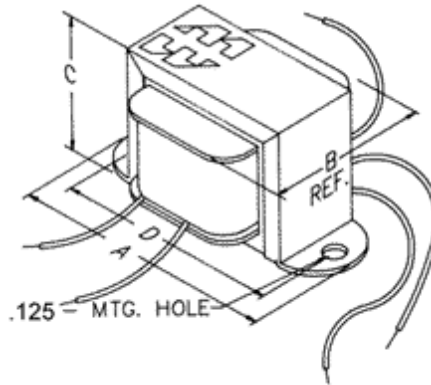

Schematic 1

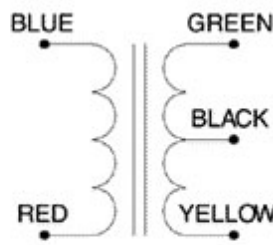

Schematic 2

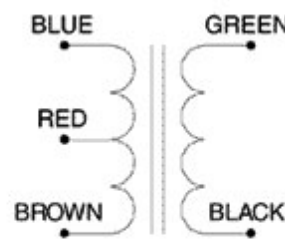

Schematic 3

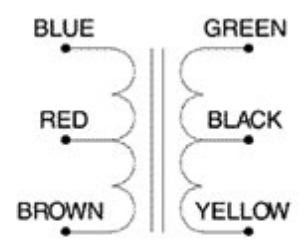

Schematic 4

Part No.	Applicaton	Nominal Impedance (Ohms)		Primary D.C. (*1) ma	D.C. Resistance (Ohms) +/- 15%		Output (mW)	Overall Dimensions				Schematic
		Primary	Secondary		Primary	Secondary		A	B	C	D	
143B	Input	3.2	4000	0	0.4	245	15	1.26	0.69	0.69	1.06	1
143D	Input	200K	1000	0	4500	30	25	1.26	0.69	0.69	1.06	1
143H	Driver	1500	500 ct	4	111	24	30	1.26	0.69	0.69	1.06	2
143J	Driver	3000	1000 ct	2.6	265	53	30	1.26	0.69	0.69	1.06	2
143L	Driver	10000	200 ct	1.5	720	9	30	1.26	0.69	0.69	1.06	2
143N	Driver	10000	2000 ct	1.5	720	89	30	1.26	0.69	0.69	1.06	2

Part No.	Applicaton	Nominal Impedance (Ohms)		Primary D.C. (*1) ma	D.C. Resistance (Ohms) +/- 15%		Output (mW)	Overall Dimensions				Schematic
		Primary	Secondary		Primary	Secondary		A	B	C	D	
143R	Driver	25000	600 ct	1	1890	25	30	1.26	0.69	0.69	1.06	2
144B	Output	200 ct	3.2	10	10	0	150	1.26	0.69	0.69	1.06	3
144D	Output	300 ct	3.2	9	15	0.33	150	1.26	0.69	0.69	1.06	3
144F	Output	500 ct	3.2	6	27	0.33	150	1.26	0.69	0.69	1.06	3
144G	Output	500 ct	8	6	27	0.9	150	1.26	0.69	0.69	1.06	3
144H	Output	500 ct	50	6	28	7.3	150	1.26	0.69	0.69	1.06	3
144I	Output	600 ct	150 ct	6	45	8.2	150	1.26	0.69	0.69	1.06	4
144P	Output	10000	3.2	5	575	0.5	50	1.26	0.69	0.69	1.06	1
144Q	Output	10000	8	5	575	0.9	50	1.26	0.69	0.69	1.06	1
144S	Output	20000	8	3.5	1240	0.9	50	1.26	0.69	0.69	1.06	1
145A	Driver	100	200 ct	45	14	19	100	1.63	0.88	0.81	1.38	2
145B	Driver-Output	600	600	18	30	38	200	1.63	0.88	0.81	1.38	1
145C	Input	50000	1500 ct	1	2400	52	50	1.63	0.88	0.81	1.38	2
145D	Input	200K	1000	0.5	3600	33	10	1.63	0.88	0.81	1.38	1
145E	Input-Output	600 ct	600 ct	5	65	83	200	1.63	0.88	0.81	1.38	4
145F	Driver	600 ct	200 ct	20	45	9	135	1.63	0.88	0.81	1.38	4
145G	Driver	2000	200 ct	12	140	9	135	1.63	0.88	0.81	1.38	2
145H	Driver	2000	500 ct	12	148	17	135	1.63	0.88	0.81	1.38	2
145J	Driver	4000	600 ct	8	340	24	135	1.63	0.88	0.81	1.38	2
145L	Driver	4000	2600 ct	8	340	100	135	1.63	0.88	0.81	1.38	2
145N	Driver	10000	2000 ct	5	700	89	135	1.63	0.88	0.81	1.38	2
145O	Driver	15000	200 ct	4	850	10	135	1.63	0.88	0.81	1.38	2
145P	Driver	20000	1000 ct	3.5	1180	50	135	1.63	0.88	0.81	1.38	2
145R	Driver	20000	2000 ct	3.5	1180	89	135	1.63	0.88	0.81	1.38	2
146B	Output	48 ct	3.2	20	2.4	0.3	700	1.63	0.88	0.81	1.38	3
146C	Output	48 ct	8	20	2.4	0.7	700	1.63	0.88	0.81	1.38	3
146D	Output	100 ct	3.2	14	4.4	0.3	700	1.63	0.88	0.81	1.38	3
146E	Output	100 ct	8	14	4.4	0.7	700	1.63	0.88	0.81	1.38	3
146F	Output	250 ct	3.2	8	11	0.3	700	1.63	0.88	0.81	1.38	3
146G	Output	250 ct	8	8	11	0.7	700	1.63	0.88	0.81	1.38	3
146H	Output	500 ct	3.2	6	26	0.3	700	1.63	0.88	0.81	1.38	3
146I	Output	500 ct	8	6	26	0.7	700	1.63	0.88	0.81	1.38	3
146J	Output	1000 ct	3.2	4	56	0.3	700	1.63	0.88	0.81	1.38	3
146K	Output	1000 ct	8	4	56	0.7	700	1.63	0.88	0.81	1.38	3
146N	Output	2000 ct	8	3	97	0.7	700	1.63	0.88	0.81	1.38	3
146S	Output	4000 ct	8	2	220	0.7	700	1.63	0.88	0.81	1.38	3

Tags: audio transformer, signal level, chassis mount, open type

Data subject to change without notice

© 2025. Hammond Manufacturing Ltd. All rights reserved.