

SFH 4055

FIREFLY®

FIREFLY® with Infrared Emitter (850 nm)

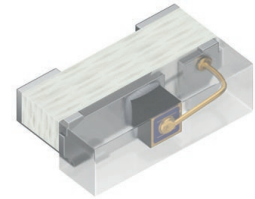

Applications

- Eye Tracking
- Gesture Recognition

Features:

- Package: clear epoxy
- ESD: 2 kV acc. to ANSI/ESDA/JEDEC JS-001 (HBM, Class 2)
- Very small package: (LxWxH) 1.0 mm x 0.55 mm x 0.325 mm
- Sidelooker

Ordering Information

Type	Radiant intensity ¹⁾ $I_F = 70 \text{ mA}; t_p = 20 \text{ ms}$ I_e	Radiant intensity ¹⁾ typ. $I_F = 70 \text{ mA}; t_p = 20 \text{ ms}$ I_e	Ordering Code
SFH 4055	4.0 ... 12.5 mW/sr	7 mW/sr	Q65112A2210

Discontinued

Maximum Ratings

$T_A = 25\text{ °C}$

Parameter	Symbol	Values
Operating temperature	T_{op}	min. -40 °C max. 85 °C
Storage temperature	T_{stg}	min. -40 °C max. 85 °C
Forward current	I_F	max. 70 mA
Surge current $t_p \leq 400\ \mu\text{s}; D = 0$	I_{FSM}	max. 0.7 A
Reverse voltage ²⁾	V_R	max. 12 V
Power consumption	P_{tot}	max. 140 mW
ESD withstand voltage acc. to ANSI/ESDA/JEDEC JS-001 (HBM, Class 2)	V_{ESD}	max. 2 kV

Characteristics

$I_F = 70 \text{ mA}$; $t_p = 20 \text{ ms}$; $T_A = 25 \text{ °C}$

Parameter	Symbol		Values
Peak wavelength	λ_{peak}	typ.	860 nm
Centroid wavelength	$\lambda_{\text{centroid}}$	typ.	850 nm
Spectral bandwidth at 50% $I_{\text{rel,max}}$ (FWHM)	$\Delta\lambda$	typ.	30 nm
Half angle	φ	typ.	70 °
Dimensions of active chip area	L x W	typ.	0.2 x 0.2 mm x mm
Rise time (10% / 90%) $I_F = 70 \text{ mA}$; $R_L = 50 \text{ }\Omega$	t_r	typ.	12 ns
Fall time (10% / 90%) $I_F = 70 \text{ mA}$; $R_L = 50 \text{ }\Omega$	t_f	typ.	12 ns
Forward voltage	V_F	typ. max.	1.6 V 2 V
Forward voltage $I_F = 500 \text{ mA}$; $t_p = 100 \text{ }\mu\text{s}$	V_F	typ.	2.4 V
Reverse current ²⁾ $V_R = 5 \text{ V}$	I_R	max.	10 μA
Radiant intensity ¹⁾ $I_F = 500 \text{ mA}$; $t_p = 100 \text{ }\mu\text{s}$	I_e	typ.	40 mW/sr
Total radiant flux ³⁾	Φ_e	typ.	40 mW
Temperature coefficient of voltage	TC_V	typ.	-0.7 mV / K
Temperature coefficient of brightness	TC_I	typ.	-0.5 % / K
Temperature coefficient of wavelength	TC_λ	typ.	0.3 nm / K
Thermal resistance junction solder point real ⁴⁾	R_{thJS}	max.	350 K / W
Thermal resistance junction ambient real ⁵⁾	R_{thJA}	max.	450 K / W

Brightness Groups

$T_A = 25\text{ °C}$

Group	Radiant intensity $I_F = 70\text{ mA}; t_p = 20\text{ ms}$ min. I_e	Radiant intensity $I_F = 70\text{ mA}; t_p = 20\text{ ms}$ max. I_e
P	4.0 mW/sr	8.0 mW/sr
Q	6.3 mW/sr	12.5 mW/sr

Only one group in one packing unit (variation lower 2:1).

Relative Spectral Emission ^{6), 7)}

$I_{e,rel} = f(\lambda); I_F = 70\text{ mA}; t_p = 20\text{ ms}$

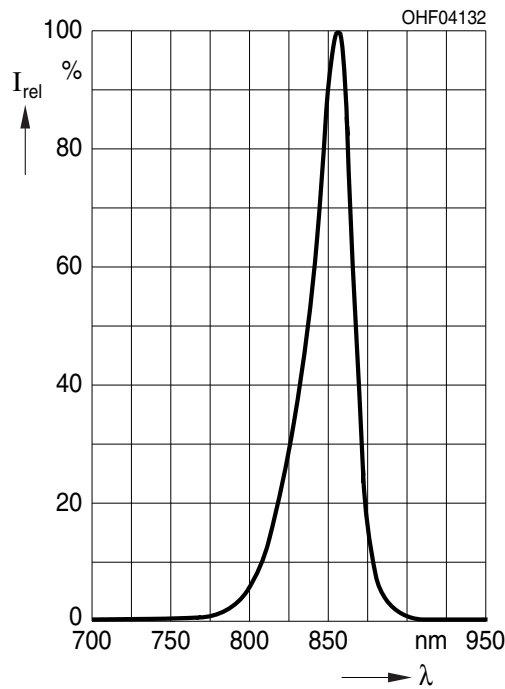

Discontinued

Radiation Characteristics (6), (7)

$I_{e,rel} = f(\varphi)$

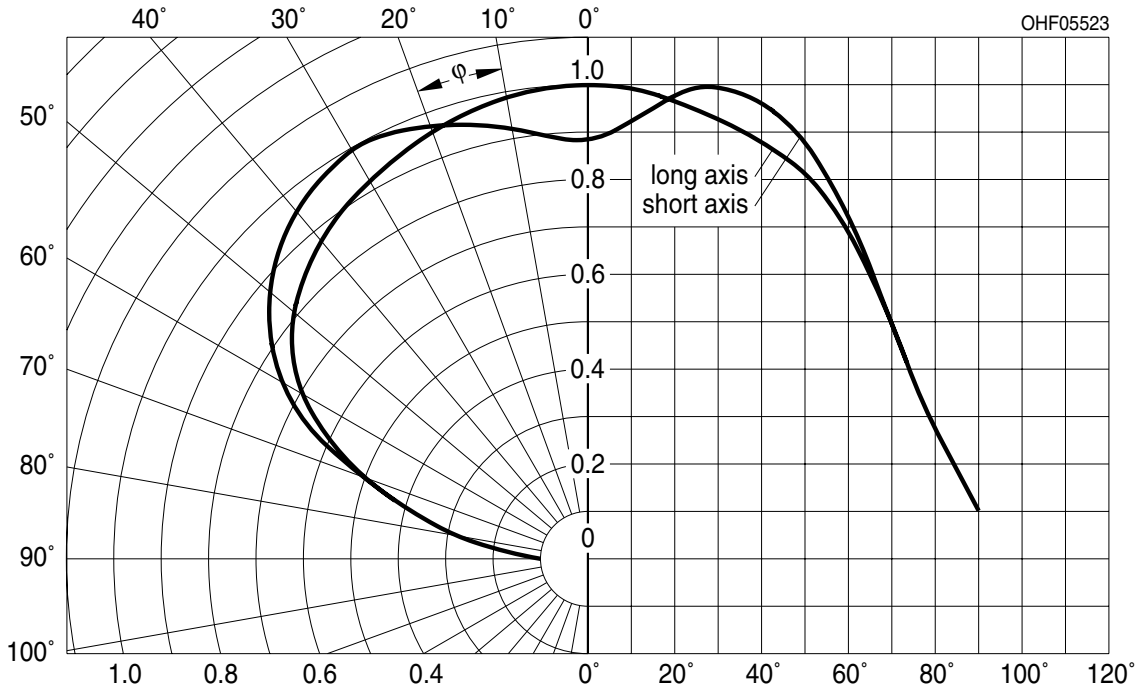

Forward current (6), (7)

$I_F = f(V_F)$; single pulse; $t_p = 100 \mu s$

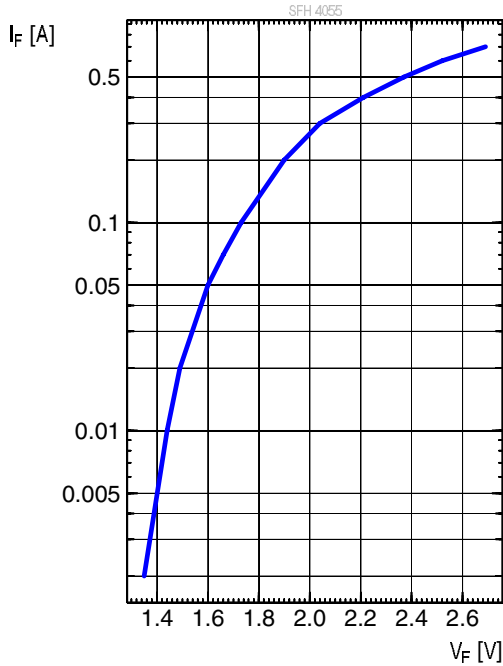

Relative Radiant Intensity (6), (7)

$I_e/I_e(70mA) = f(I_F)$; single pulse; $t_p = 25 \mu s$

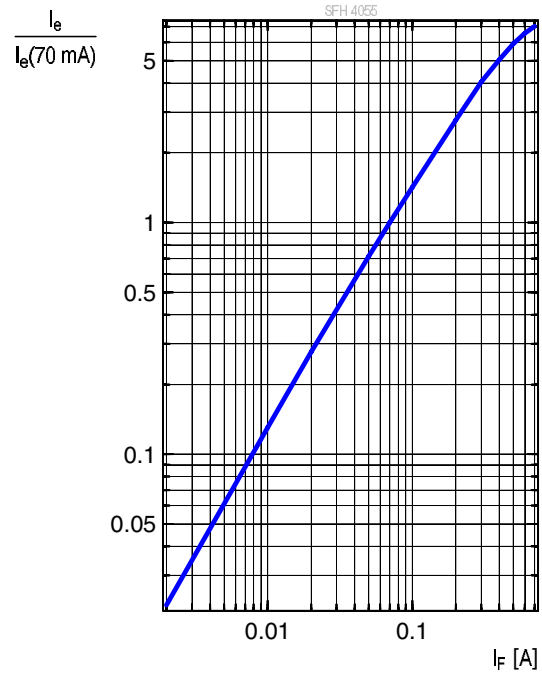

Discontinued

Max. Permissible Forward Current

$I_{F,max} = f(T_A)$; $R_{th,ja} = 450K / W$; single pulse

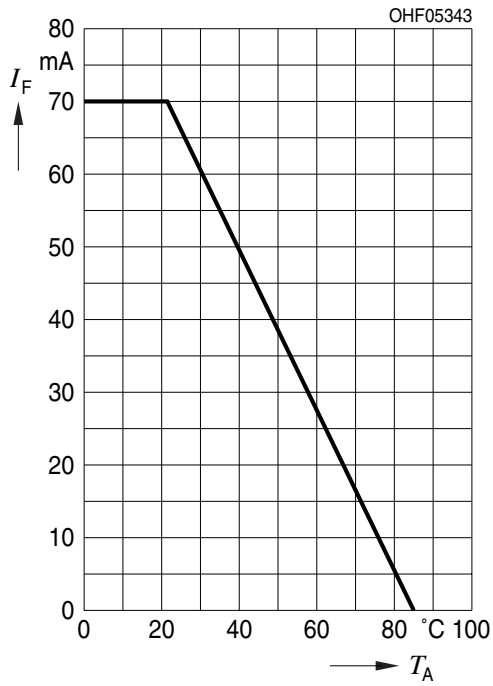

Permissible Pulse Handling Capability

$I_F = f(t_p)$; duty cycle $D = \text{parameter}$; $T_A = 25^\circ C$

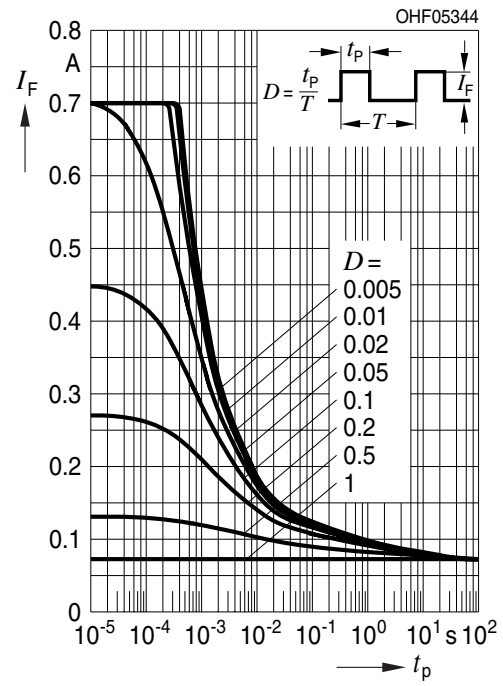

Dimensional Drawing ⁸⁾

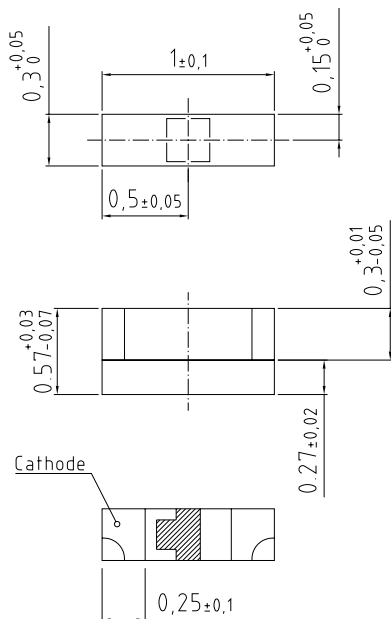

C63062-A4024-A1.-05

Further Information

Approximate Weight: 0.6 mg

Package marking: Cathode

Recommended Solder Pad ⁸⁾

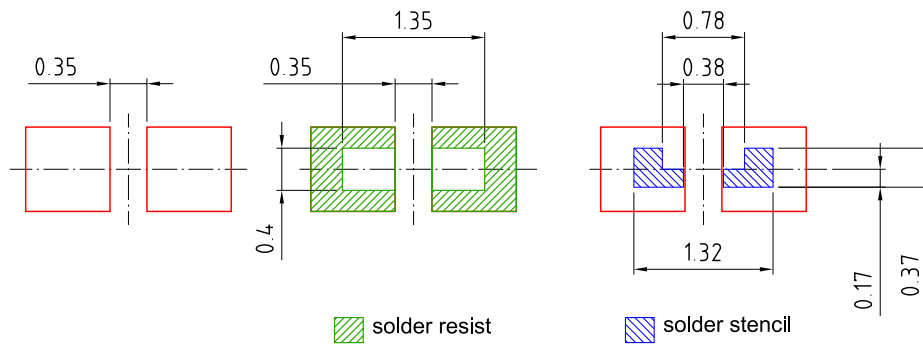

Component Location on Pad

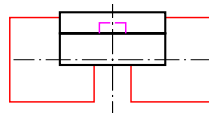

E062.3010.66 -04

Reflow Soldering Profile

Product complies to MSL Level 3 acc. to JEDEC J-STD-020E



Profile Feature	Symbol	Pb-Free (SnAgCu) Assembly			Unit
		Minimum	Recommendation	Maximum	
Ramp-up rate to preheat ^{*)} 25 °C to 150 °C			2	3	K/s
Time t_s T_{Smin} to T_{Smax}	t_s	60	100	120	s
Ramp-up rate to peak ^{*)} T_{Smax} to T_p			2	3	K/s
Liquidus temperature	T_L		217		°C
Time above liquidus temperature	t_L		80	100	s
Peak temperature	T_p		245	260	°C
Time within 5 °C of the specified peak temperature $T_p - 5$ K	t_p	10	20	30	s
Ramp-down rate* T_p to 100 °C			3	6	K/s
Time 25 °C to T_p				480	s

All temperatures refer to the center of the package, measured on the top of the component
 *) slope calculation DT/Dt : Dt max. 5 s; fulfillment for the whole T-range

Discontinued

Taping ⁸⁾

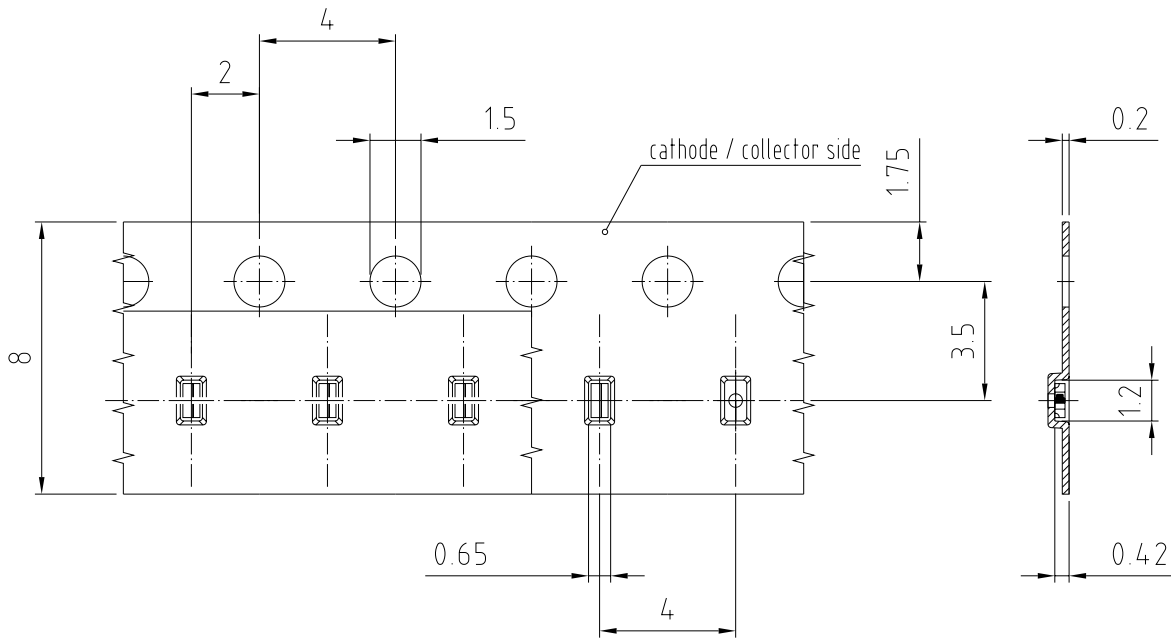

C63062-A4355-B1-01

Tape and Reel ⁹⁾

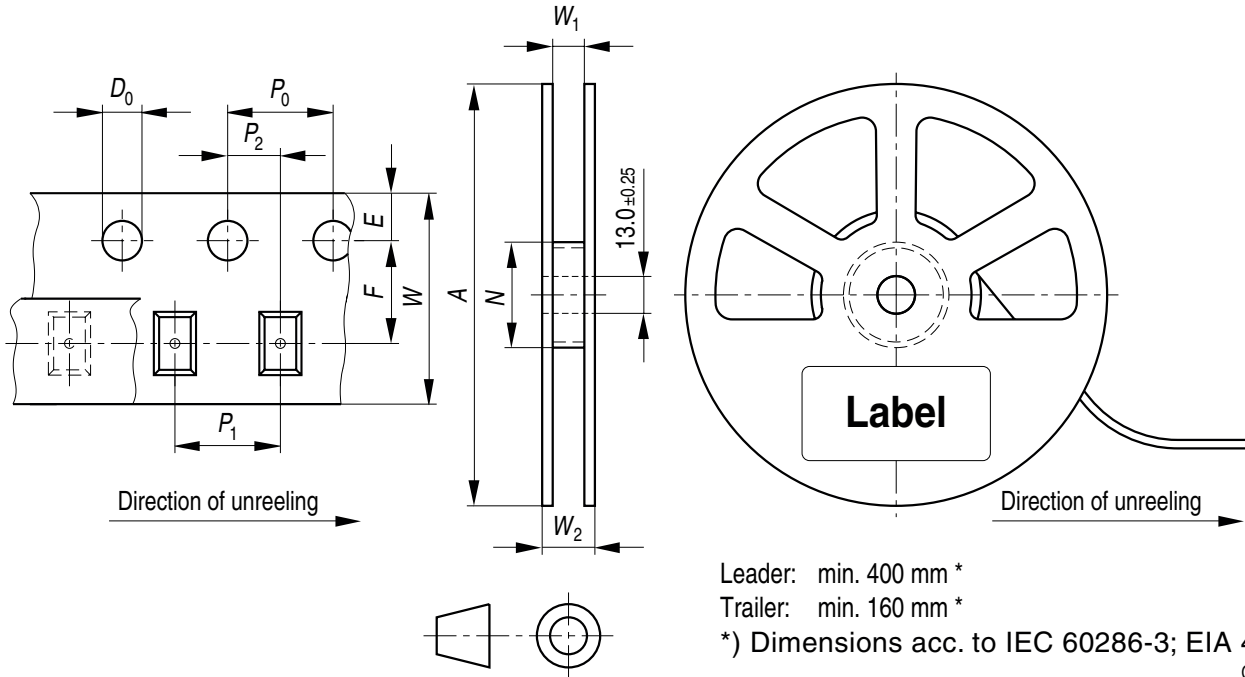

Leader: min. 400 mm *

Trailer: min. 160 mm *

*) Dimensions acc. to IEC 60286-3; EIA 481-D

OHAY0324

Reel Dimensions

A	W	N_{min}	W_1	W_{2max}	Pieces per PU
180 mm	$8 + 0.3 / - 0.1$ mm	60 mm	$8.4 + 2$ mm	14.4 mm	3000

Discontinued

Barcode-Product-Label (BPL)

OSRAM Opto Semiconductors LX XXXX BIN1: XX-XX-X-XXX-X

RoHS Compliant

(6P) BATCH NO: 1234567890 ML Temp ST
X XXX °C X

(1T) LOT NO: 1234567890 (9D) D/C: 1234 Pack: RXX
DEMY XXX
X_X123_1234.1234 X

(X) PROD NO: 123456789(Q)QTY: 9999 (G) GROUP: XX-XX-X-X

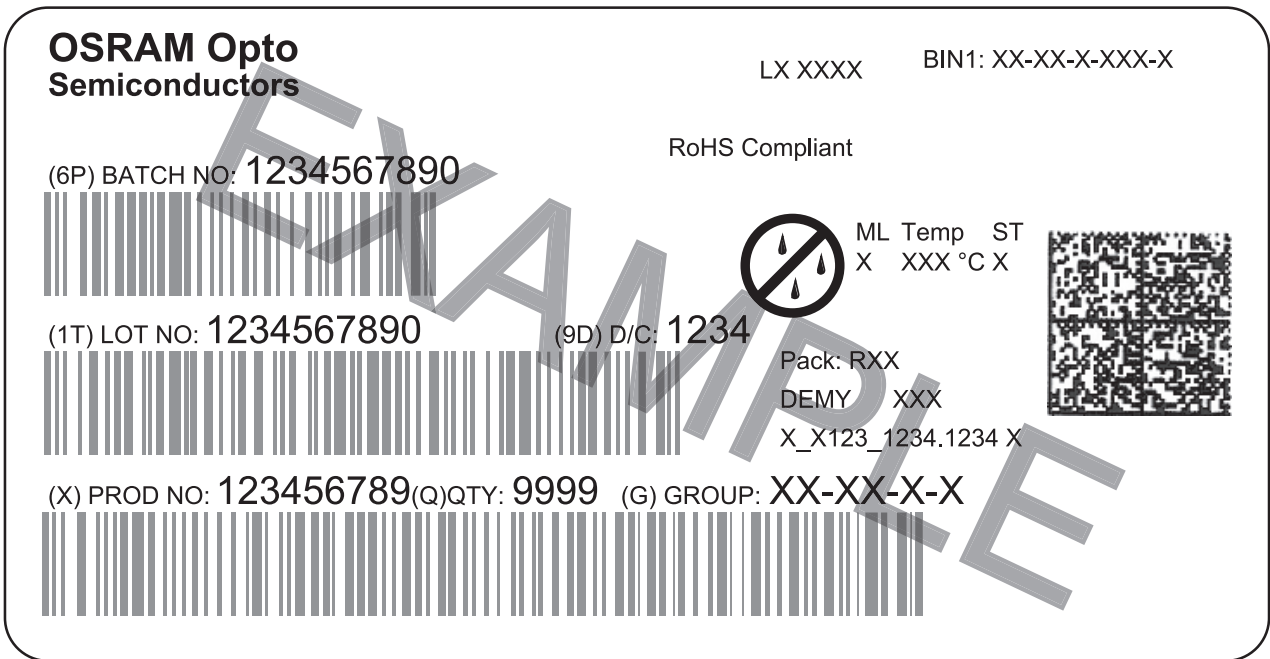

The diagram shows a rectangular label with rounded corners. It contains the OSRAM logo and product name at the top left. To the right are fields for 'LX XXXX' and 'BIN1: XX-XX-X-XXX-X'. Below the logo is 'RoHS Compliant'. The label features three horizontal barcode sections. The first is labeled '(6P) BATCH NO: 1234567890' and is associated with 'ML Temp ST X XXX °C X' and a moisture-sensitive symbol (a circle with a diagonal line and three droplets). The second is labeled '(1T) LOT NO: 1234567890' and '(9D) D/C: 1234', with 'Pack: RXX', 'DEMY XXX', and 'X_X123_1234.1234 X' below it. The third is labeled '(X) PROD NO: 123456789(Q)QTY: 9999' and '(G) GROUP: XX-XX-X-X'. A square QR code is located on the right side of the label.

OHA04563

Dry Packing Process and Materials ⁸⁾



OHA00539

Moisture-sensitive product is packed in a dry bag containing desiccant and a humidity card according JEDEC-STD-033.

Discontinued

Schematic Transportation Box ⁸⁾

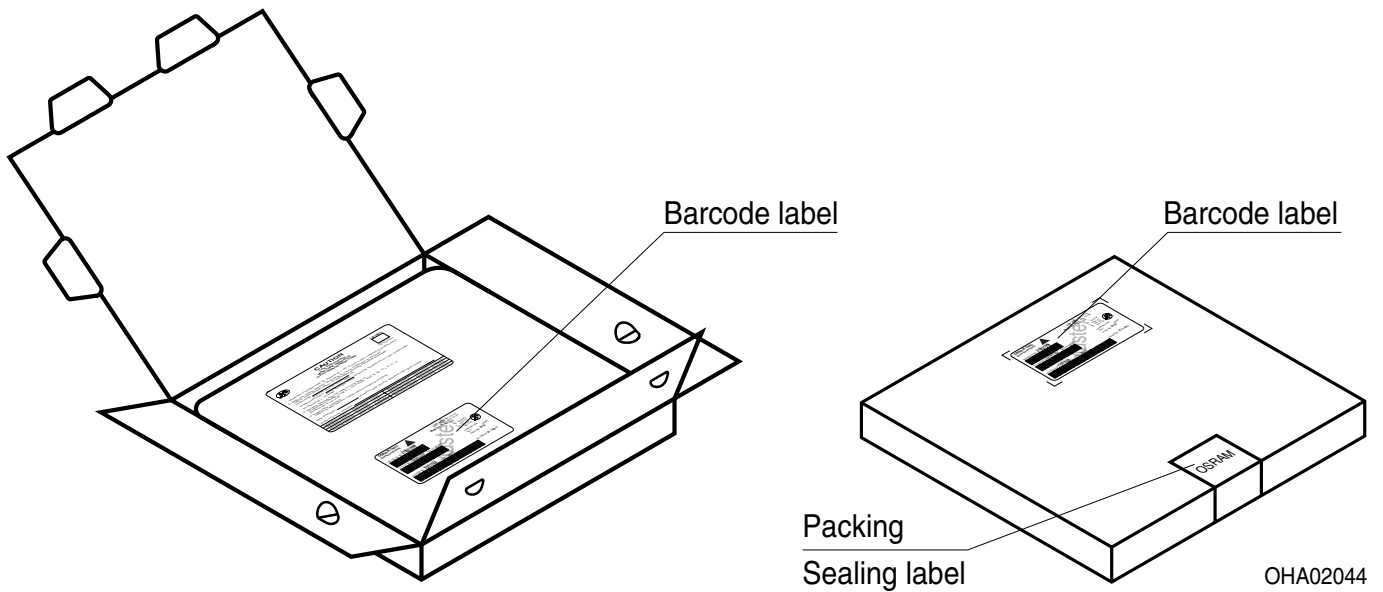

Dimensions of Transportation Box

Width	Length	Height
200 ± 5 mm	195 ± 5 mm	30 ± 5 mm

Notes

The evaluation of eye safety occurs according to the standard IEC 62471:2006 (photo biological safety of lamps and lamp systems). Within the risk grouping system of this IEC standard, the device specified in this data sheet falls into the class **exempt group (exposure time 10000 s)**. Under real circumstances (for exposure time, conditions of the eye pupils, observation distance), it is assumed that no endangerment to the eye exists from these devices. As a matter of principle, however, it should be mentioned that intense light sources have a high secondary exposure potential due to their blinding effect. When looking at bright light sources (e.g. headlights), temporary reduction in visual acuity and afterimages can occur, leading to irritation, annoyance, visual impairment, and even accidents, depending on the situation.

Subcomponents of this device contain, in addition to other substances, metal filled materials including silver. Metal filled materials can be affected by environments that contain traces of aggressive substances. Therefore, we recommend that customers minimize device exposure to aggressive substances during storage, production, and use. Devices that showed visible discoloration when tested using the described tests above did show no performance deviations within failure limits during the stated test duration. Respective failure limits are described in the IEC60810.

For further application related information please visit www.osram-os.com/appnotes

Disclaimer

Attention please!

The information describes the type of component and shall not be considered as assured characteristics. Terms of delivery and rights to change design reserved. Due to technical requirements components may contain dangerous substances.

For information on the types in question please contact our Sales Organization.

If printed or downloaded, please find the latest version on the OSRAM OS website.

Packing

Please use the recycling operators known to you. We can also help you – get in touch with your nearest sales office. By agreement we will take packing material back, if it is sorted. You must bear the costs of transport. For packing material that is returned to us unsorted or which we are not obliged to accept, we shall have to invoice you for any costs incurred.

Product and functional safety devices/applications or medical devices/applications

OSRAM OS components are not developed, constructed or tested for the application as safety relevant component or for the application in medical devices.

OSRAM OS products are not qualified at module and system level for such application.

In case buyer – or customer supplied by buyer – considers using OSRAM OS components in product safety devices/applications or medical devices/applications, buyer and/or customer has to inform the local sales partner of OSRAM OS immediately and OSRAM OS and buyer and /or customer will analyze and coordinate the customer-specific request between OSRAM OS and buyer and/or customer.

Glossary

- 1) **Radiant intensity:** Measured at a solid angle of $\Omega = 0.01$ sr
- 2) **Reverse Operation:** Reverse Operation of 10 hours is permissible in total. Continuous reverse operation is not allowed.
- 3) **Total radiant flux:** Measured with integrating sphere.
- 4) **Thermal resistance:** junction - soldering point, of the device only, mounted on an ideal heatsink (e.g. metal block)
- 5) **Thermal resistance:** junction - ambient, mounted on PC-board (FR4), padsize 5 mm² each
- 6) **Typical Values:** Due to the special conditions of the manufacturing processes of semiconductor devices, the typical data or calculated correlations of technical parameters can only reflect statistical figures. These do not necessarily correspond to the actual parameters of each single product, which could differ from the typical data and calculated correlations or the typical characteristic line. If requested, e.g. because of technical improvements, these typ. data will be changed without any further notice.
- 7) **Testing temperature:** TA = 25°C (unless otherwise specified)
- 8) **Tolerance of Measure:** Unless otherwise noted in drawing, tolerances are specified with ± 0.1 and dimensions are specified in mm.
- 9) **Tape and Reel:** All dimensions and tolerances are specified acc. IEC 60286-3 and specified in mm.

Revision History

Version	Date	Change
1.4	2019-07-15	Discontinued

Published by OSRAM Opto Semiconductors GmbH EU RoHS and China RoHS compliant product
Leibnizstraße 4, D-93055 Regensburg
www.osram-os.com © All Rights Reserved.



此产品符合欧盟 RoHS 指令的要求；
按照中国的相关法规和标准，不含有毒有害物质或元素。