

# OSRAM LE B P2MQ

## Datasheet

Published by **ams-OSRAM AG**

Tobelbader Strasse 30, 8141 Premstaetten, Austria

Phone +43 3136 500-0

[ams-osram.com](http://ams-osram.com)

© All rights reserved



## OSRAM OSTAR® Projection Power

# LE B P2MQ

OSRAM OSTAR Projection Power is a high luminance LED for projection applications.

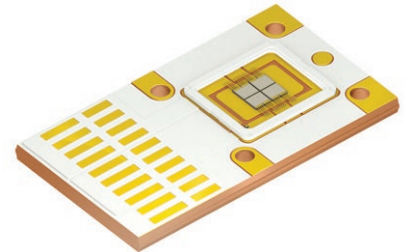

### Applications

- Projection & Display
- Visualization

### Features

- Package: OSTAR High Power Projection
- Chip technology: UX:3
- Typ. Radiation: 120° (Lambertian emitter)
- Color:  $\lambda_{\text{dom}} = 456 \text{ nm}$  (• blue)
- ESD: 2 kV acc. to ANSI/ESDA/JEDEC JS-001 (HBM, Class 2)

### Ordering Information

Type	Total radiant flux <sup>1)</sup> $I_F = 10000 \text{ mA}$ $\Phi_e$	Ordering Code
LE B P2MQ-HTJQ-23	39000 ... 52000 mW	Q65115A0641

## Maximum Ratings

Parameter	Symbol		Values
Storage Temperature	$T_{stg}$	min. max.	-40 °C 85 °C
Junction Temperature	$T_j$	max.	150 °C
Forward Current $T_j = T_{j,max}$	$I_F$	min. max.	200 mA 10000 mA
Forward Current pulsed $D = 0.7; f = 240 \text{ Hz}; T_j = T_{j,max}$	$I_{F \text{ pulse}}$		12000 mA
Surge Current $t_p \leq 50 \mu\text{s}; D = 0.1; T_j = T_{j,max}$	$I_{FS}$	max.	14000 mA
ESD withstand voltage acc. to ANSI/ESDA/JEDEC JS-001 (HBM, Class 2)	$V_{ESD}$		2 kV
Reverse current <sup>2)</sup>	$I_R$	max.	200 mA
Max. voltage difference anode-board, cathode-board	$\Delta V_{a-b}, \Delta V_{c-b}$	max.	40 V

## Characteristics

$I_F = 10000 \text{ mA}$ ;  $T_B = 25 \text{ °C}$

Parameter	Symbol	Values
Peak Wavelength	$\lambda_{\text{peak}}$	typ. 450 nm
Dominant Wavelength <sup>3)</sup>	$\lambda_{\text{dom}}$	min. 452 nm
		typ. 456 nm
		max. 460 nm
Spectral bandwidth at 50% $I_{\text{rel,max}}$	$\Delta\lambda$	typ. 25 nm
Viewing angle at 50% $I_V$	$2\phi$	typ. 120 °
Radiating surface	$A_{\text{color}}$	typ. 3.2 x 2.6 mm <sup>2</sup>
Partial Flux acc. CIE 127:2007 <sup>4)</sup> $I_F = 10000 \text{ mA}$	$\Phi_{\text{E/V, 120°}}$	typ. 0.77
Forward Voltage <sup>5)</sup> $I_F = 10000 \text{ mA}$	$V_F$	min. 14.0 V
		typ. 16.0 V
		max. 18.0 V
Reverse voltage (ESD device)	$V_{\text{R ESD}}$	min. 45 V
Reverse voltage <sup>2)</sup> $I_R = 20 \text{ mA}$	$V_R$	max. 1.2 V
Real thermal resistance junction/board	$R_{\text{thJB real}}$	typ. 0.7 K / W
Electrical thermal resistance junction/board with efficiency $\eta_e = 28 \%$	$R_{\text{thJB elec.}}$	typ. 0.50 K / W

## Brightness Groups

Group	Total radiant flux <sup>1)</sup> $I_F = 10000 \text{ mA}$ min. $\Phi_e$	Total radiant flux <sup>1)</sup> $I_F = 10000 \text{ mA}$ max. $\Phi_e$
HT	39000 mW	41900 mW
HU	41900 mW	45000 mW
JP	45000 mW	48400 mW
JQ	48400 mW	52000 mW

## Wavelength Groups

Group	Dominant Wavelength <sup>3)</sup> min. $\lambda_{\text{dom}}$	Dominant Wavelength <sup>3)</sup> max. $\lambda_{\text{dom}}$
2	452 nm	456 nm
3	456 nm	460 nm

## Group Name on Label

### Example: HT-2

Brightness	Wavelength
HT	2

### Relative Spectral Emission <sup>4)</sup>

$E_{rel} = f(\lambda); I_F = 10000 \text{ mA}; T_J = 25 \text{ }^\circ\text{C}$

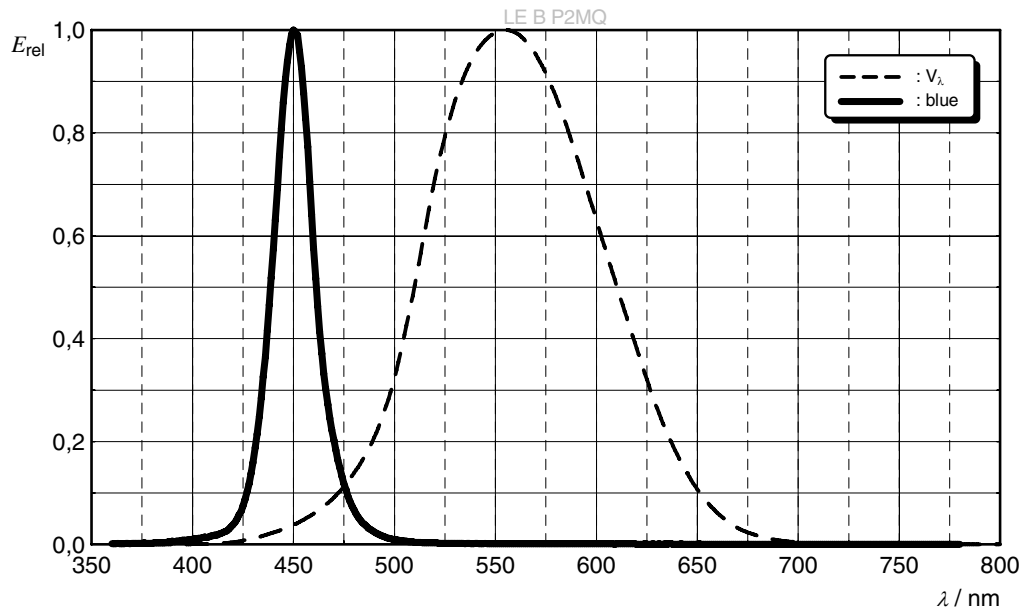

### Radiation Characteristics <sup>4)</sup>

$I_{rel} = f(\varphi); T_J = 25 \text{ }^\circ\text{C}$

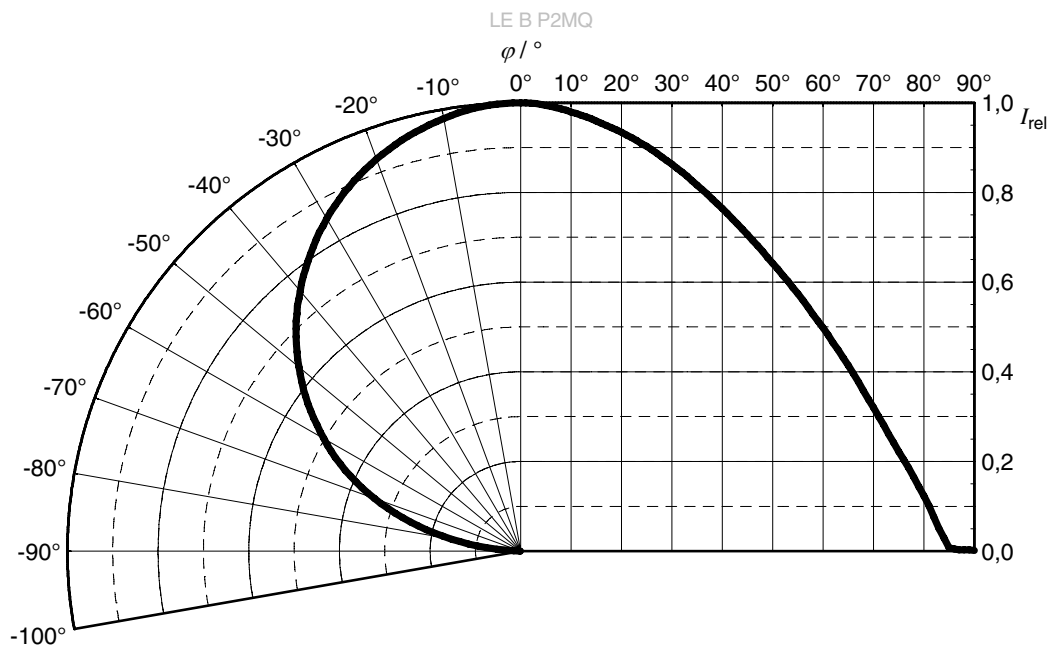

### Relative Partial Flux <sup>4)</sup>

$$\Phi_E(2\varphi)/\Phi_E(180^\circ) = f(\varphi); T_J = 25^\circ\text{C}$$

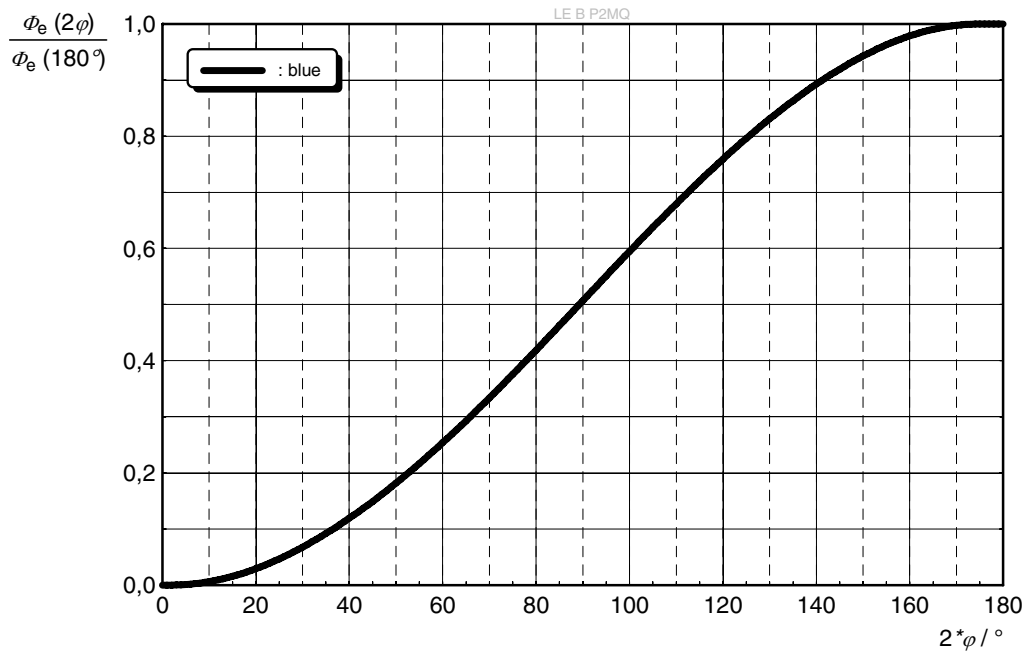

### Forward current <sup>4)</sup>

$$I_F = f(V_F); T_J = 25 \text{ }^\circ\text{C}$$

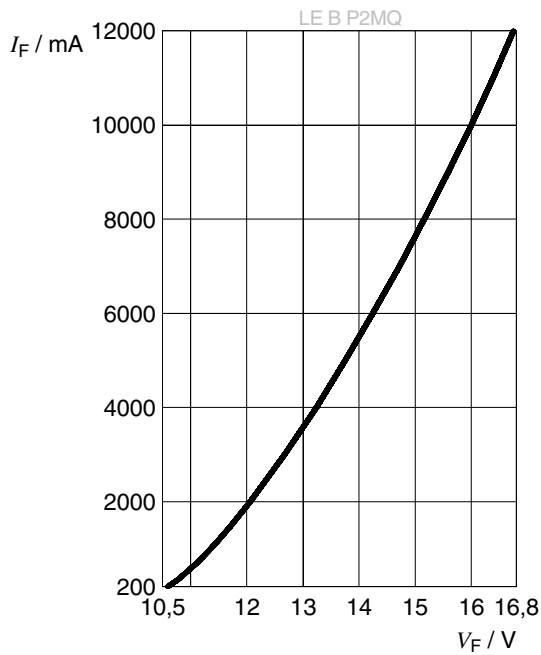

### Relative Radiant Power <sup>4), 6)</sup>

$$\Phi_E / \Phi_E(10000 \text{ mA}) = f(I_F); T_J = 25 \text{ }^\circ\text{C}$$

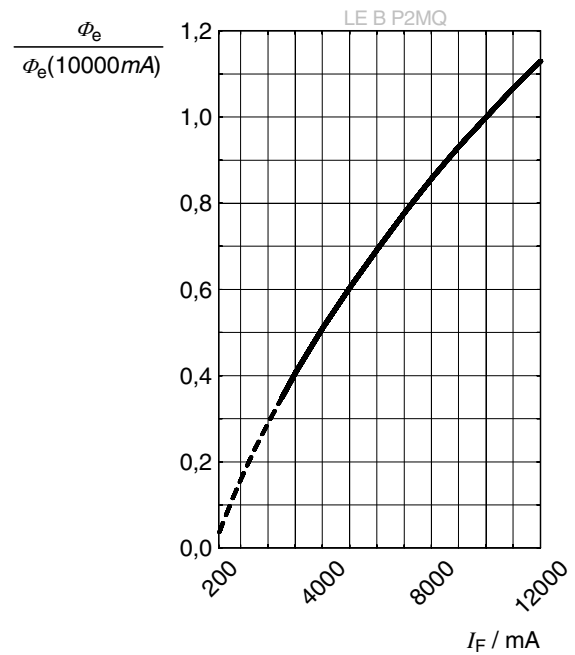

### Dominant Wavelength <sup>4)</sup>

$$\Delta\lambda_{\text{dom}} = f(I_F); T_J = 25 \text{ }^\circ\text{C}$$

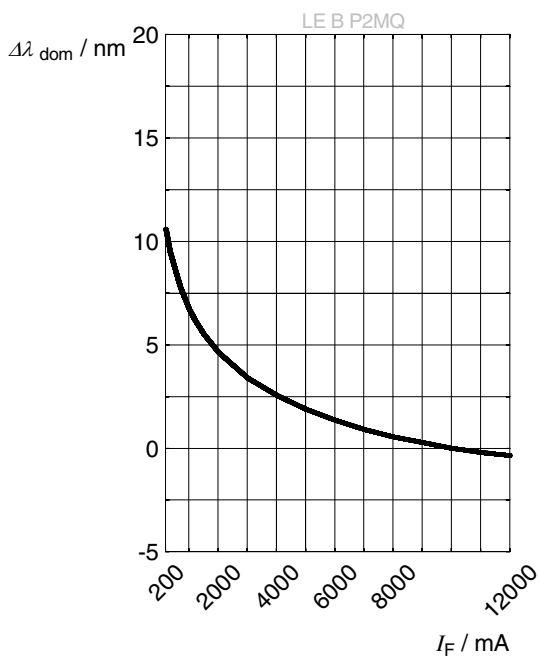



### Forward Voltage <sup>4)</sup>

$$\Delta V_F = V_F - V_F(25\text{ °C}) = f(T_j); I_F = 10000\text{ mA}$$

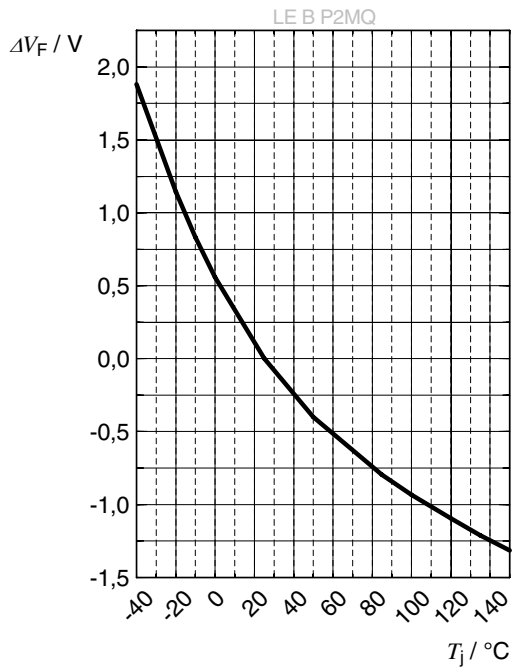

### Relative Radiant Power <sup>4)</sup>

$$\Phi_E / \Phi_E(25\text{ °C}) = f(T_j); I_F = 10000\text{ mA}$$

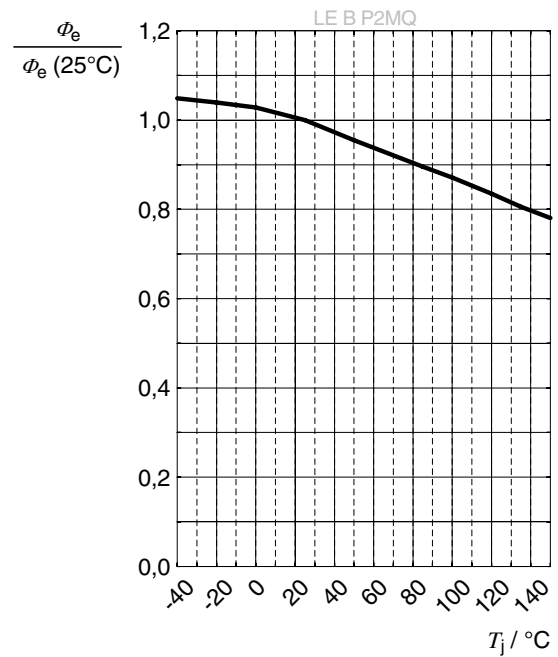

### Dominant Wavelength <sup>4)</sup>

$$\Delta \lambda_{\text{dom}} = \lambda_{\text{dom}} - \lambda_{\text{dom}}(25\text{ °C}) = f(T_j); I_F = 10000\text{ mA}$$

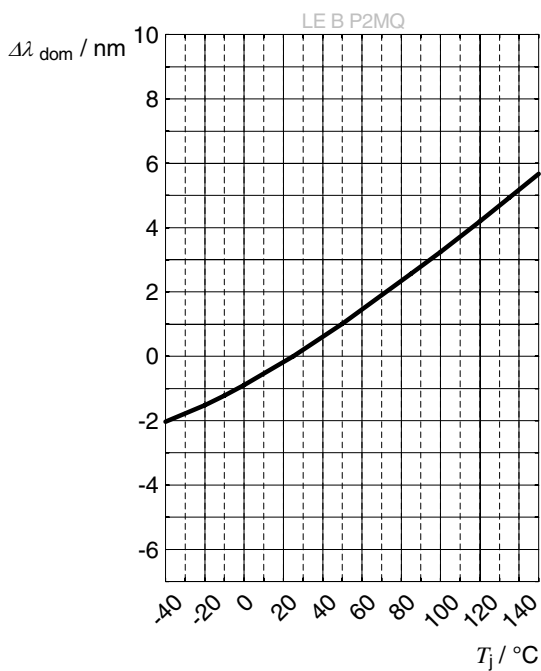



### Electrical Internal Circuit

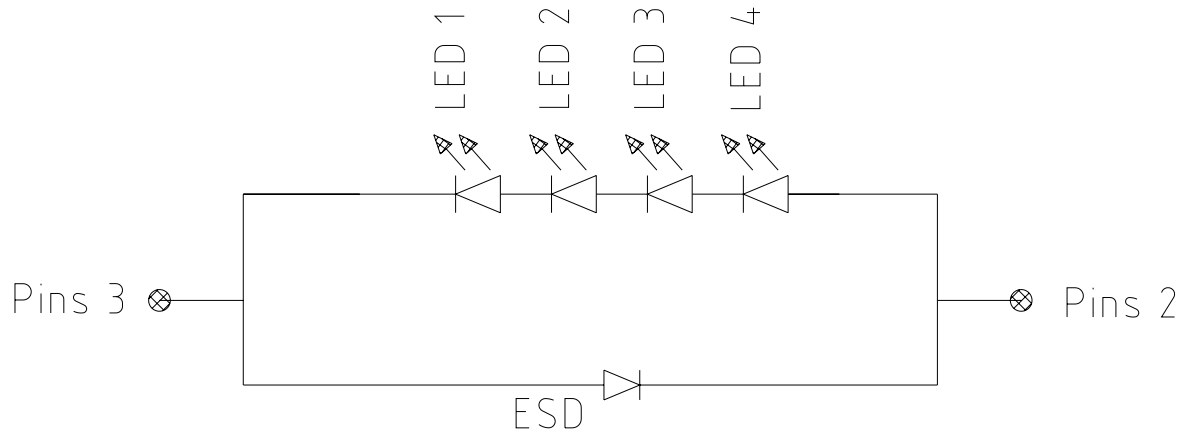

- Pins 1: Substrate potential, isolated from Cathode and Anode
- Pins 2: Anode
- Pins 3: Cathode

### Reflow Soldering Profile

Product complies to MSL Level 2 acc. to JEDEC J-STD-020E

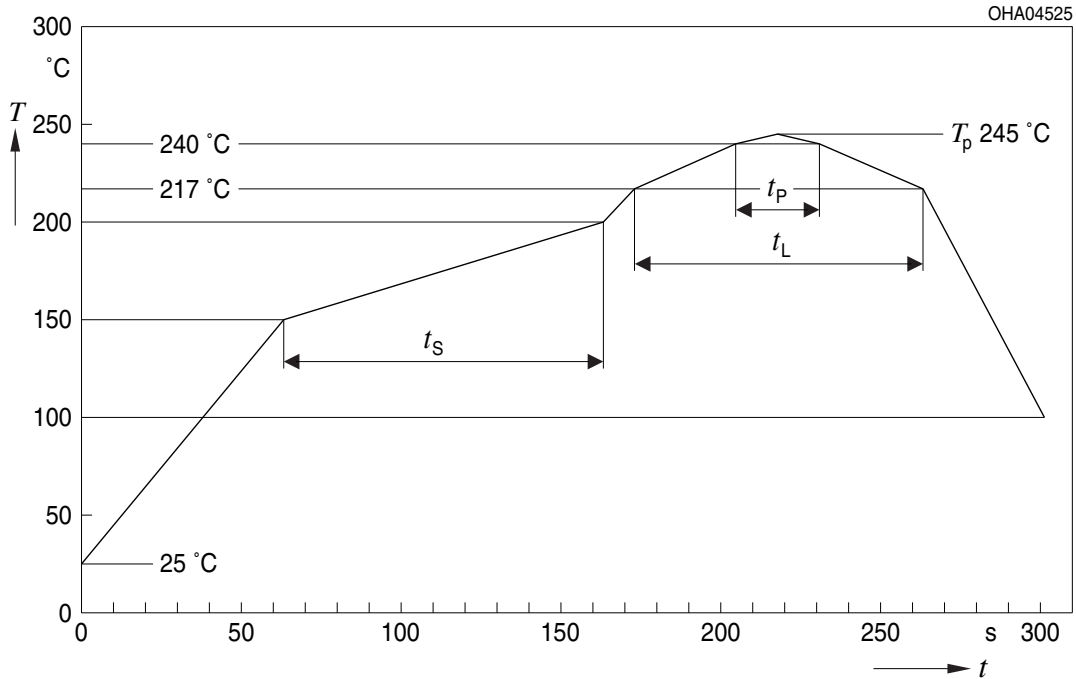

Profile Feature	Symbol	Pb-Free (SnAgCu) Assembly			Unit
		Minimum	Recommendation	Maximum	
Ramp-up rate to preheat <sup>*)</sup> 25 °C to 150 °C			2	3	K/s
Time $t_s$ $T_{Smin}$ to $T_{Smax}$	$t_s$	60	100	120	s
Ramp-up rate to peak <sup>*)</sup> $T_{Smax}$ to $T_p$			2	3	K/s
Liquidus temperature	$T_L$		217		°C
Time above liquidus temperature	$t_L$		80	100	s
Peak temperature	$T_p$		245	260	°C
Time within 5 °C of the specified peak temperature $T_p - 5$ K	$t_p$	10	20	30	s
Ramp-down rate* $T_p$ to 100 °C			3	6	K/s
Time 25 °C to $T_p$				480	s

All temperatures refer to the center of the package, measured on the top of the component  
 \*) slope calculation  $DT/Dt$ :  $Dt$  max. 5 s; fulfillment for the whole T-range

Tray <sup>7)</sup>

38 pieces per tray

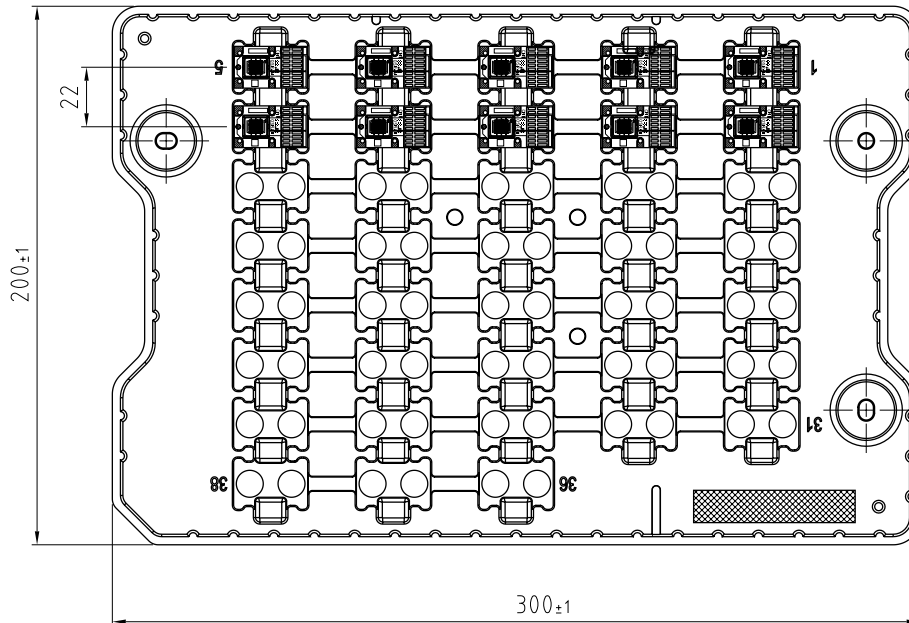

C63062-A4389-B10-01

Barcode-Product-Label (BPL)

**OSRAM** LX XXXX BIN1: XX-XX-X-XXX-X

RoHS Compliant





(6P) BATCH NO: 1234567890

(1T) LOT NO: 1234567890 (9D) D/C: 1234

(X) PROD NO: 123456789(Q)QTY: 9999 (G) GROUP: XX-XX-X-X

ML Temp ST  
X XXX °C X

Pack: RXX  
DEMY XXX  
X\_X123\_1234.1234 X



OHA04563



Barcode-Tray-Label (BTL)

LE xxx xxx Group: xxxx-xxxx-xxxx

Data Matrix Code

xxxx BIN

MATERIAL: Material Number Batch Batch Number BIN: xxxx



OHA02684\_1

## Schematic Transportation Box <sup>7)</sup>

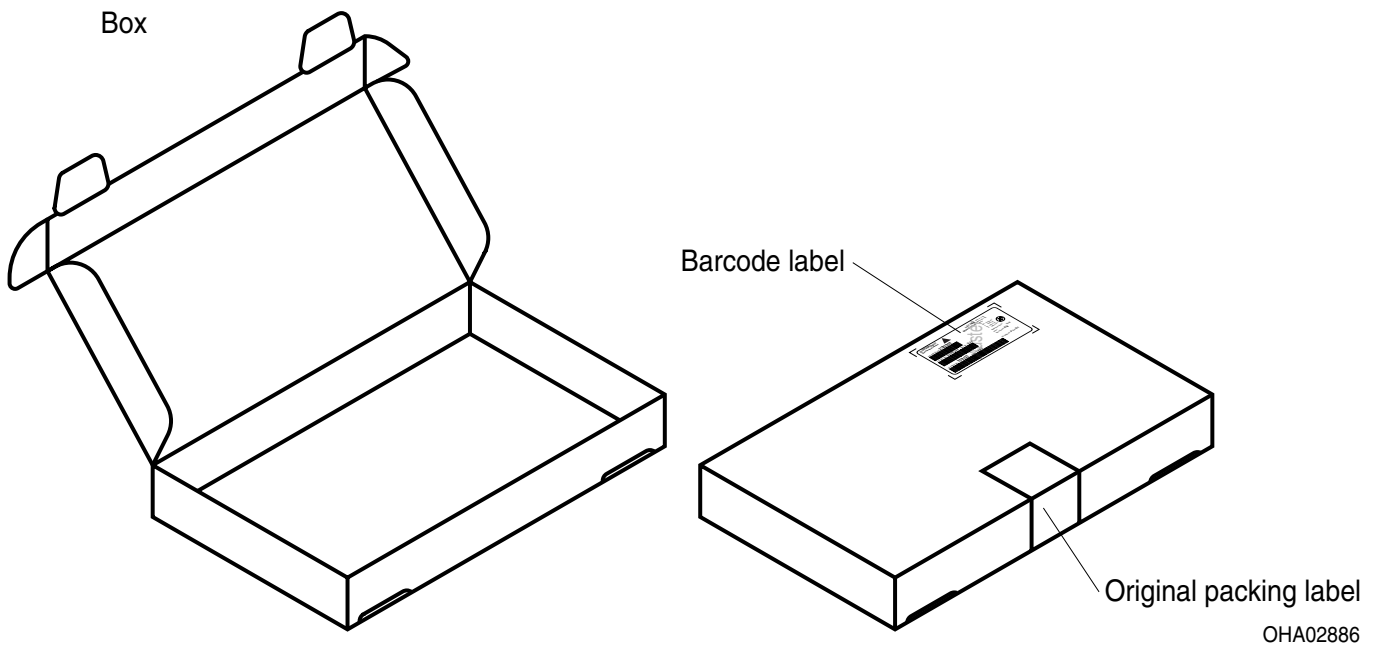

## Dimensions of Transportation Box

Width	Length	Height
333 ± 5 mm	218 ± 5 mm	28 ± 5 mm
337 ± 5 mm	218 ± 5 mm	63 ± 5 mm

## Data Matrix Code Description

The Data Matrix Code bin information is Laser marked during testing

Content: aaaa@bbbb@ccc@dddd@eeee

Data Matrix Code Type: ECC200

a = Luminous Flux (Phiv) [lm] or Radiant Flux (Phie) [W] (example: 3306)

b = Forward Voltage (Vf) [V] (example: 3.46)

c = Wavelength (Ldom) [nm] (example: 618)

d = Color Coordinate Cx (example: 0.321)

e = Color Coordinate Cy (example: 0.641)

@: Seperator = Blank



---

## Notes

The evaluation of eye safety occurs according to the standard IEC 62471:2006 (photo biological safety of lamps and lamp systems). Within the risk grouping system of this IEC standard, the device specified in this data sheet fall into the class **moderate risk (exposure time 0.25 s)**. Under real circumstances (for exposure time, conditions of the eye pupils, observation distance), it is assumed that no endangerment to the eye exists from these devices. As a matter of principle, however, it should be mentioned that intense light sources have a high secondary exposure potential due to their blinding effect. When looking at bright light sources (e.g. headlights), temporary reduction in visual acuity and afterimages can occur, leading to irritation, annoyance, visual impairment, and even accidents, depending on the situation.

Subcomponents of this device contain, in addition to other substances, metal filled materials including silver. Metal filled materials can be affected by environments that contain traces of aggressive substances. Therefore, we recommend that customers minimize device exposure to aggressive substances during storage, production, and use. Devices that showed visible discoloration when tested using the described tests above did show no performance deviations within failure limits during the stated test duration. Respective failure limits are described in the IEC60810.

For further application related information please visit <https://ams-osram.com/support/application-notes>

## Disclaimer

### Attention please!

The information describes the type of component and shall not be considered as assured characteristics. Terms of delivery and rights to change design reserved. Due to technical requirements components may contain dangerous substances.

For information on the types in question please contact our Sales Organization.

If printed or downloaded, please find the latest version on our website.

### Packing

Please use the recycling operators known to you. We can also help you – get in touch with your nearest sales office. By agreement we will take packing material back, if it is sorted. You must bear the costs of transport. For packing material that is returned to us unsorted or which we are not obliged to accept, we shall have to invoice you for any costs incurred.

### Product and functional safety devices/applications or medical devices/applications

Our components are not developed, constructed or tested for the application as safety relevant component or for the application in medical devices.

Our products are not qualified at module and system level for such application.

In case buyer – or customer supplied by buyer – considers using our components in product safety devices/ applications or medical devices/applications, buyer and/or customer has to inform our local sales partner immediately and we and buyer and /or customer will analyze and coordinate the customer-specific request between us and buyer and/or customer.

---

## Glossary

- 1) **Brightness:** Brightness values are measured during a current pulse of typically 1 ms, with an internal reproducibility of  $\pm 8\%$  and an expanded uncertainty of  $\pm 11\%$  (acc. to GUM with a coverage factor of  $k = 3$ ).
- 2) **Reverse Operation:** This product is intended to be operated applying a forward current within the specified range. Applying any continuous reverse bias or forward bias below the voltage range of light emission shall be avoided because it may cause migration which can change the electro-optical characteristics or damage the LED.
- 3) **Wavelength:** The wavelength is measured at a current pulse of typically 1 ms, with an internal reproducibility of  $\pm 0.5$  nm and an expanded uncertainty of  $\pm 1$  nm (acc. to GUM with a coverage factor of  $k = 3$ ).
- 4) **Typical Values:** Due to the special conditions of the manufacturing processes of semiconductor devices, the typical data or calculated correlations of technical parameters can only reflect statistical figures. These do not necessarily correspond to the actual parameters of each single product, which could differ from the typical data and calculated correlations or the typical characteristic line. If requested, e.g. because of technical improvements, these typ. data will be changed without any further notice.
- 5) **Forward Voltage:** The forward voltage is measured during a current pulse of typically 1 ms, with an internal reproducibility of  $\pm 0.05$  V and an expanded uncertainty of  $\pm 0.1$  V (acc. to GUM with a coverage factor of  $k = 3$ ).
- 6) **Characteristic curve:** In the range where the line of the graph is broken, you must expect higher differences between single devices within one packing unit.
- 7) **Tolerance of Measure:** Unless otherwise noted in drawing, tolerances are specified with  $\pm 0.1$  and dimensions are specified in mm.

## Revision History

Version	Date	Change
1.0	2019-08-16	Initial Version
1.0	2019-09-18	Initial Version
1.1	2020-02-18	Maximum Ratings Characteristics
1.1	2020-02-18	Maximum Ratings Characteristics
1.2	2021-03-19	Characteristics Maximum Ratings Ordering Information Brightness Groups Dimensional Drawing
1.3	2024-04-12	Characteristics Ordering Information Brightness Groups Glossary Electro - Optical Characteristics (Diagrams)
1.4	2025-03-10	Ordering Information Characteristics Brightness Groups Electro - Optical Characteristics (Diagrams)



EU RoHS and China RoHS compliant product

此产品符合欧盟 RoHS 指令的要求；  
按照中国的相关法规和标准，  
不含有毒有害物质或元素。

**Published by ams-OSRAM AG**

Tobelbader Strasse 30, 8141 Premstaetten, Austria

Phone +43 3136 500-0

[ams-osram.com](http://ams-osram.com)

© All rights reserved

**am**  **OSRAM**