

IRIS

~10° spot beam with holder optimized for Luminus SST-50

SPECIFICATION:

Dimensions	Ø 38.0
Height	28.1 mm
Fastening	glue, pin, screw
ROHS compliant	yes ⓘ

MATERIALS:

Component	Type	Material	Colour	Finish	Length (mm)
C10781_IRIS	Single lens	PMMA	clear		
C11534_IRIS-SST-HLD	Holder	PC	black		

ORDERING INFORMATION:

Quantities for one set:

Single lens	1
Holder	1



Component		Qty in box	MOQ	MPQ	Box weight (kg)
C10781_IRIS	Single lens	580	116	58	9.0
» Box size: 480 x 280 x 300 mm					
C11534_IRIS-SST-HLD	Holder	1044	116	29	6.8
» Box size: 480 x 280 x 300 mm					

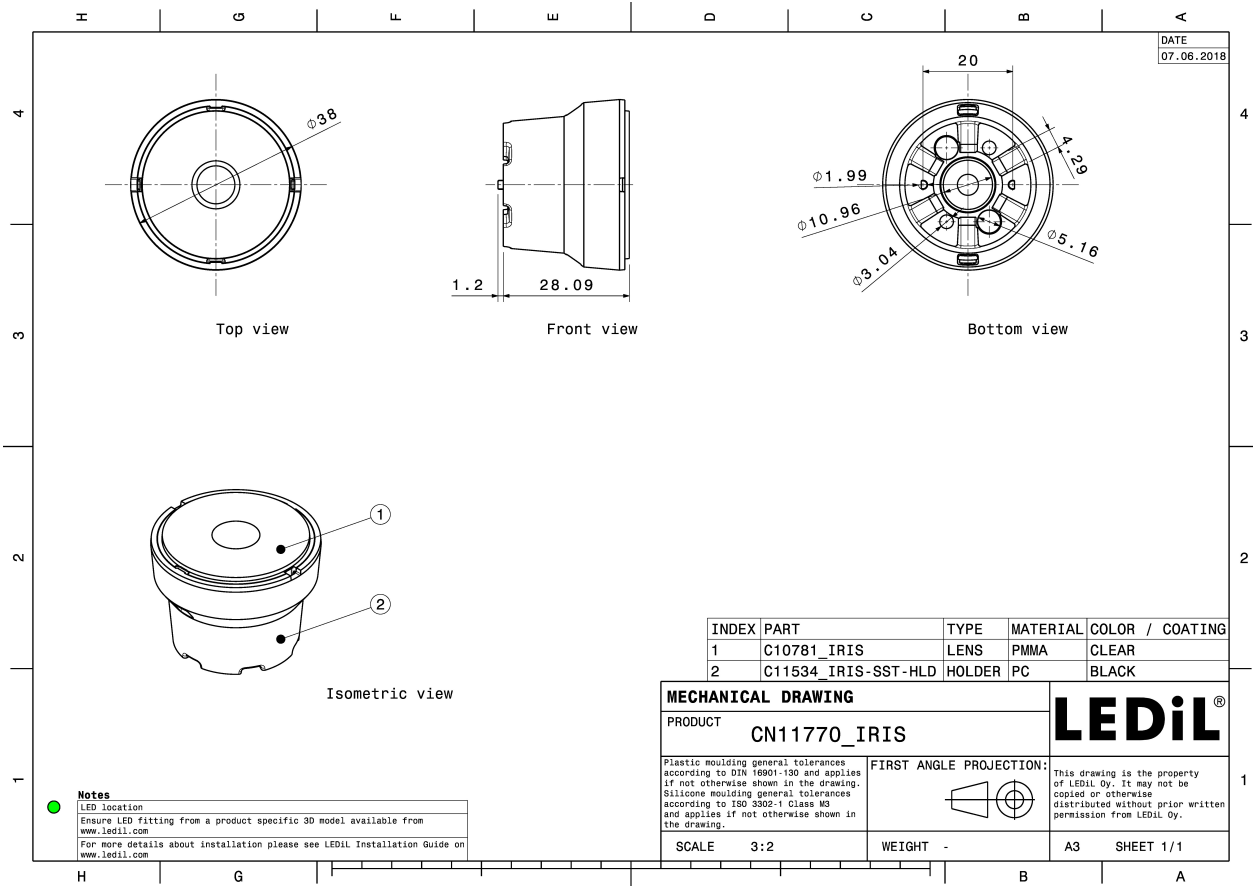

See also our general installation guide: www.ledil.com/installation_guide

OPTICAL RESULTS (MEASURED):



LED MHD-E/G
FWHM / FWTM 18.0° / 36.0°
Efficiency 93 %
Peak intensity 5.7 cd/lm
LEDs/each optic 1
Light colour/type White
Required components:

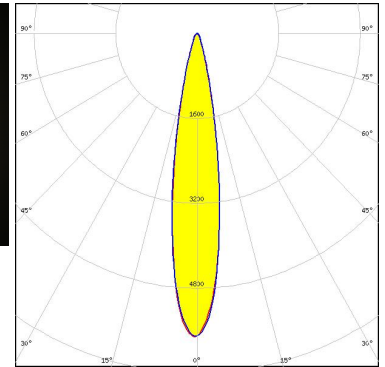
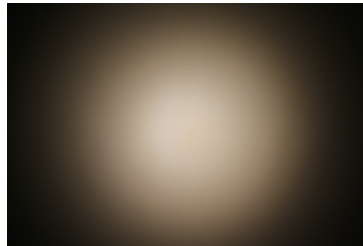

Light distribution files



LED XHP35 HD
FWHM / FWTM 12.0° / 28.0°
Efficiency 85 %
Peak intensity 10 cd/lm
LEDs/each optic 1
Light colour/type White
Required components:

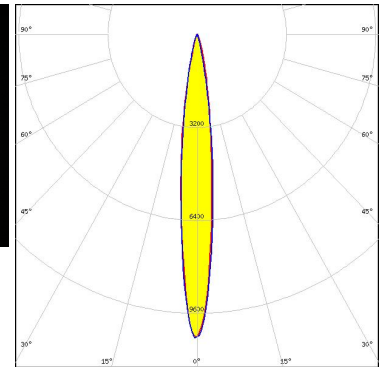

Light distribution files



LED XHP35 HI
FWHM / FWTM 11.0° / 24.0°
Efficiency 87 %
Peak intensity 14 cd/lm
LEDs/each optic 1
Light colour/type White
Required components:

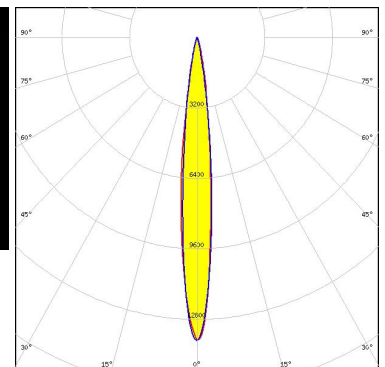
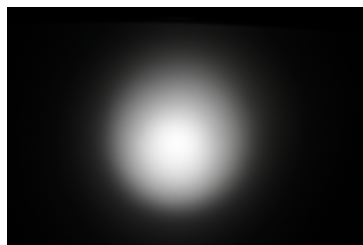

Light distribution files

OPTICAL RESULTS (MEASURED):



LED XHP50
 FWHM / FWTM 13.0° / 30.0°
 Efficiency 83 %
 Peak intensity 9.1 cd/lm
 LEDs/each optic 1
 Light colour/type White
 Required components:

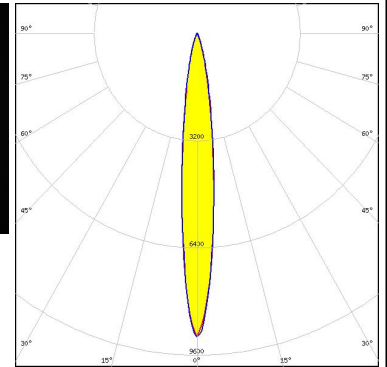

Light distribution files



LED XHP70
 FWHM / FWTM 14.0° / 39.0°
 Efficiency 90 %
 Peak intensity 5.7 cd/lm
 LEDs/each optic 1
 Light colour/type White
 Required components:

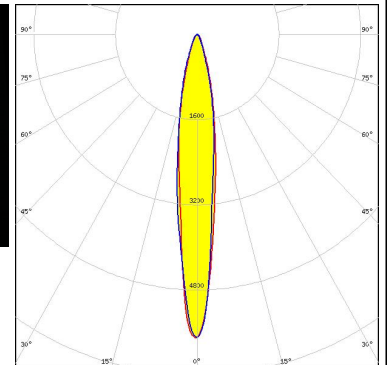

Light distribution files



LED SST-90
 FWHM / FWTM 17.0° / 31.0°
 Efficiency 0 %
 Peak intensity 6.3 cd/lm
 LEDs/each optic 1
 Light colour/type White
 Required components:

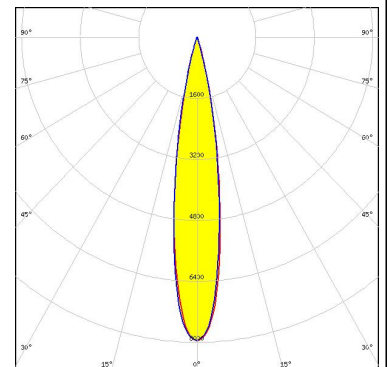

Light distribution files

OPTICAL RESULTS (MEASURED):



LED NV9W149AM
FWHM / FWTM 19.0° / 40.0°
Efficiency 80 %
Peak intensity 4.7 cd/lm
LEDs/each optic 1
Light colour/type White
Required components:

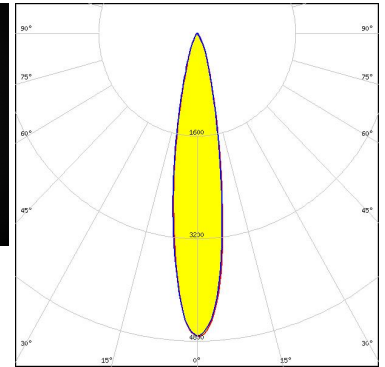

Light distribution files



LED Duris S10
FWHM / FWTM 15.0° / 35.0°
Efficiency 83 %
Peak intensity 7.1 cd/lm
LEDs/each optic 1
Light colour/type White
Required components:

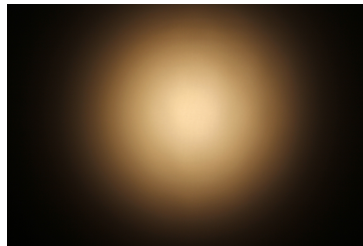

Light distribution files

OPTICAL RESULTS (SIMULATED):



LED J Series 5050B 6V K Class
FWHM / FWTM 14.0° / 24.0°
Efficiency 92 %
Peak intensity 14.1 cd/lm
LEDs/each optic 1
Light colour/type White
Required components:

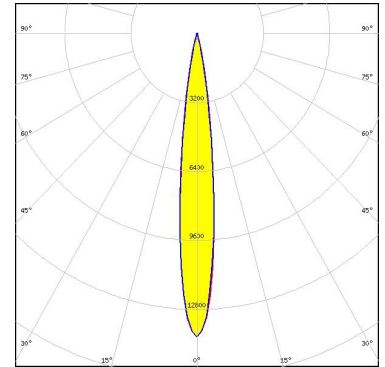

Light distribution files



LED J Series 5050C 6V E Class
FWHM / FWTM 12.0° / 24.0°
Efficiency 92 %
Peak intensity 15.6 cd/lm
LEDs/each optic 1
Light colour/type White
Required components:

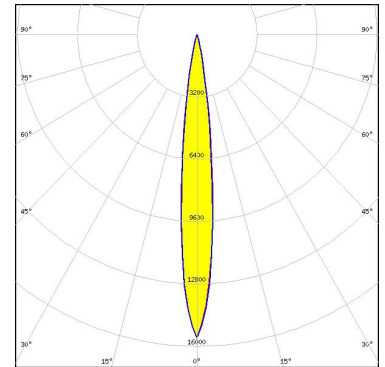

Light distribution files



LED SBT-90
FWHM / FWTM 12.0° / 20.0°
Efficiency 93 %
Peak intensity 20.6 cd/lm
LEDs/each optic 1
Light colour/type Red
Required components:

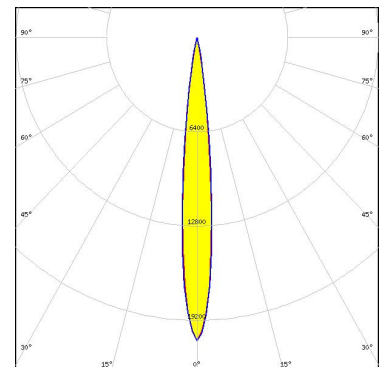

Light distribution files

OPTICAL RESULTS (SIMULATED):



LED SFT-25R-W-A
 FWHM / FWTM 8.0° / 14.0°
 Efficiency 92 %
 Peak intensity 41.4 cd/lm
 LEDs/each optic 1
 Light colour/type White
 Required components:

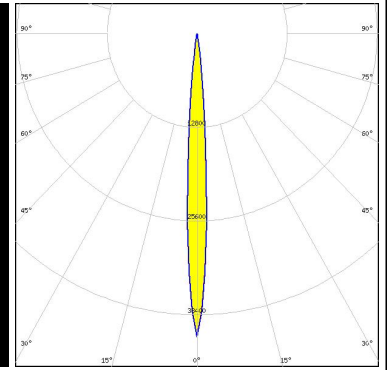
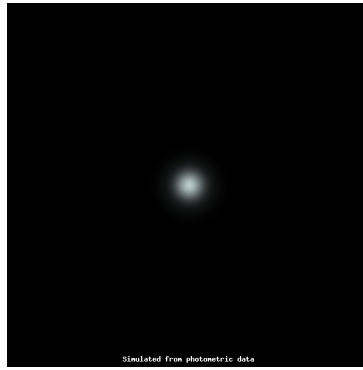

Light distribution files



LED SST-25-W
 FWHM / FWTM 8.0° / 16.0°
 Efficiency 91 %
 Peak intensity 30.4 cd/lm
 LEDs/each optic 1
 Light colour/type White
 Required components:

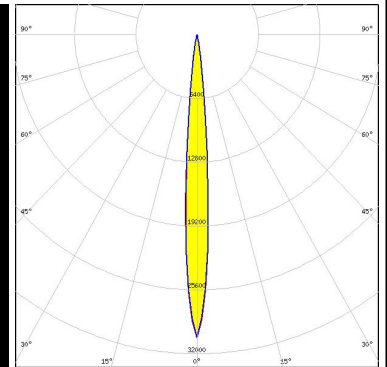
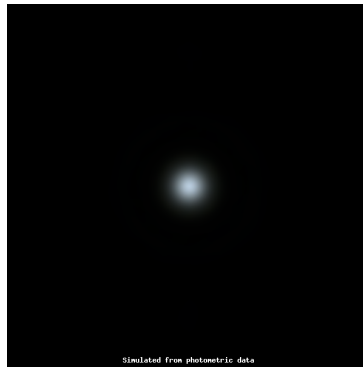

Light distribution files



LED SST-90
 FWHM / FWTM 16.0° / 28.0°
 Efficiency 91 %
 Peak intensity 10 cd/lm
 LEDs/each optic 1
 Light colour/type Red
 Required components:

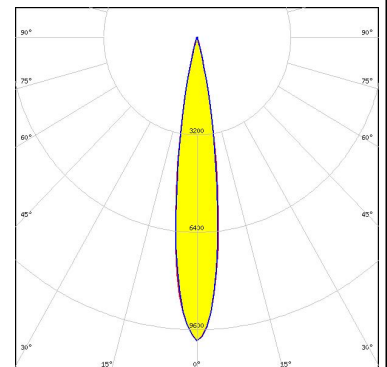

Light distribution files

OPTICAL RESULTS (SIMULATED):



LED	NV4x144A
FWHM / FWTM	14.0° / 26.0°
Efficiency	91 %
Peak intensity	11.6 cd/m
LEDs/each optic	1
Light colour/type	White
Required components:	

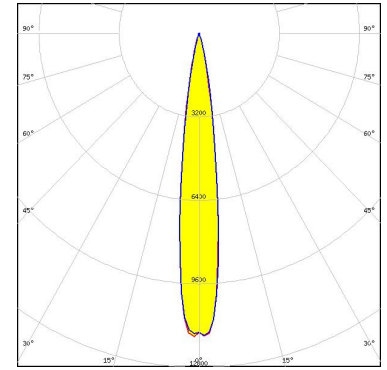

Light distribution files

GENERAL INFORMATION:

NOTE: The typical beam angle will be changed by different color, chip size and chip position tolerance. The typical total beam angle is the full angle measured where the luminous intensity is half of the peak value.

MATERIALS:

As part of our continuous research and improvement processes, and to ensure the best possible quality and availability of our products, LEDiL reserves the right to change material grades without notice.

PRODUCT DATA USER AGREEMENT AND DISCLAIMER:

The measured data in the provided downloadable LEDiL Product Datasheets and Mechanical 2D-Drawings is rounded and provided as reference for planning. LEDiL Oy's optical specifications have been verified by conducting performance testing of the products in accordance with the company's quality system. The reported data are averaged results of multiple measurements with typical variation. LEDiL Oy reserves the right to without prior notification make changes and improvements to its products.

LEDiL Oy assumes neither warranty, nor guarantee nor any other liability of any kind for the contents and correctness of the provided data. The provided data has been generated with highest diligence but the provided data may in reality not represent the complete possible variation range of all intrinsic parameters. Therefore, in certain cases a deviation from the provided data could occur.

LEDiL Oy reserves the right to undertake technical changes of its products without further notification which could lead to changes in the provided data. LEDiL Oy assumes no liability of any kind for the possible deviation from any provided data or any other damage resulting from the usage of the provided data.

The user agrees to this disclaimer and user agreement with the download or usage of the provided files.

LEDiL Oy

Joensuunkatu 7
FI-24240 SALO
Finland

LEDiL Inc.

228 West Page Street
Suite D
Sycamore IL 60178
USA

Ledil Optics Technology (Shenzhen) Co., Ltd.

405 , Block B
Casic Motor Building
Shenzhen 518057
P.R.CHINA

Local sales and technical support

[www.ledil.com/
where_to_buy](http://www.ledil.com/where_to_buy)

Shipping locations

Poznan, Poland
Hong Kong, China

Distribution Partners

[www.ledil.com/
where_to_buy](http://www.ledil.com/where_to_buy)