

Rev	AWO #	Description	Date	Appr
-		RELEASED	11/16/18	

APPROVED: _____
DATE: _____ TITLE: _____

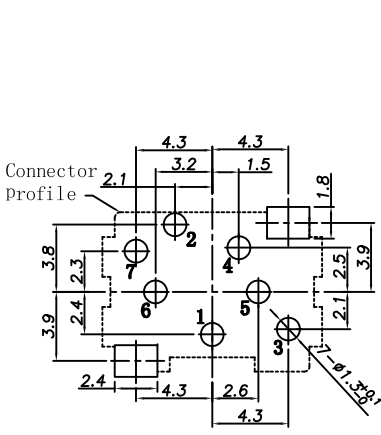

RECOMMENDED PCB LAYOUT
(BOTTOM VIEW)

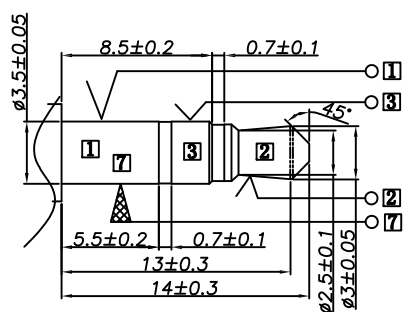
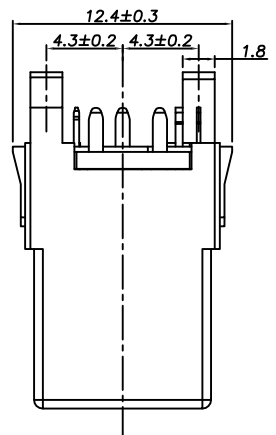

MATE PLUG

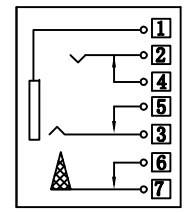
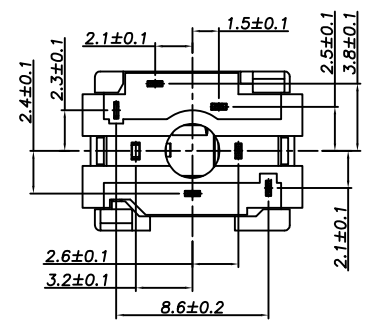
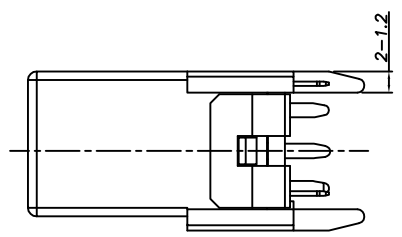
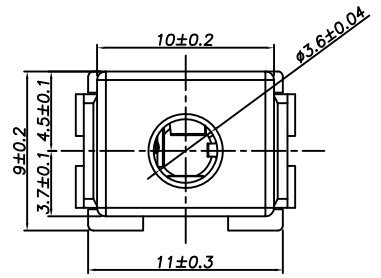

Schematic code

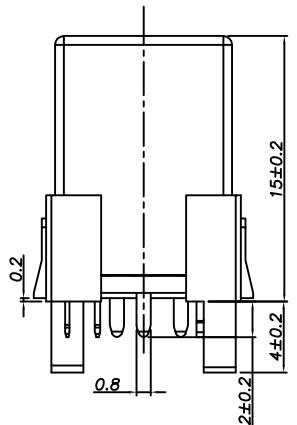

SPECIFICATIONS:
Material:
Housing: Hi-Temp Thermoplastic, rated UL94V-0, Color: Black
Contacts: Copper Alloy
Plating:
Tin over Copper underplate overall
Electrical:
Rating: 12VDC, 2A
Contact Resistance: 30 mohm max.
Insulation Resistance: 100 Mohm min. @ 500 VDC
Dielectric withstanding voltage: 500 VAC
Temperature Rating:
Operating temperature: -20°C to +70°C
Environmental:
Lead free, RoHS compliant.



UNLESS OTHERWISE SPECIFIED ALL DIMENSIONS ARE MILLIMETERS TOLERANCES: EXCEPT AS NOTED MM ANGLE		
± 0.30	± 2°	
APPROVALS		DATE
DRAWN	HR	11/16/18
CHECKED	AC1	11/16/18
APPROVED		

ADAM TECH INTERCONNECTS 909 Rahway Avenue,
Union, NJ 07083
Phone: 908-687-5000
Fax: 908-687-5710

TITLE: **3.5MM STEREO PHONE JACK, VERTICAL**

SIZE X	PART NO. ASJ-197-U-HT	REV. -
REF: S00002C	SCALE: NTS	SHEET 1 OF 1