

Data Sheet No.:E18021

Version:V5

Date:2024/03/09



RTCS0500

High Precision High Current Alloy Shunt

Resistance	100$\mu\Omega$~150$\mu\Omega$
Tolerance	$\pm 0.1\%$
Rated Current	500A
Output Voltage	50mV~75mV

Applications

Automotive Electronics
Testing & Measurement
Engineering Machinery
Power Equipment
Energy Storage Equipment

**Better Solution for Sustainable
High End Manufacturing**



Excellent Current Sensing Capability Low Current Coefficient & Thermal EMF Versus Copper

Introduction

High precision high current alloy shunt is based on a resistive alloy independently developed by C&B Electronics and brazed after precision processing. Based on controlling the consistency of alloy, precision processing, manufacturing process and precision brazing, the product can achieve a current sensing accuracy of 0.1% at a rated current of 10% to 100%. This series of products will undergo 100% power-on testing before delivery, and the data of individual products are traceable.

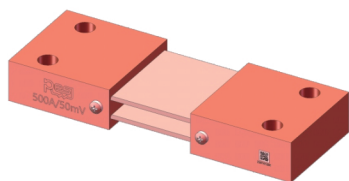

For a high current shunt, its resistance value and surface temperature will continuously change with loading. The temperature coefficient of resistance and the change in internal structure of the resistor after heating are the main factors causing the change in resistance. When the surface temperature reaches thermal equilibrium, the resistance will stabilize. Based on C&B Electronics' precise control of the ingredient, manufacturing, and heat treatment process of the resistive alloy, this series of products can achieve a temperature coefficient of $\pm 20\text{ppm}/^\circ\text{C}$ within the range of -20°C to $+120^\circ\text{C}$, with low thermal EMF versus copper and current coefficient.



This series, from raw materials, core equipment, to core processes, achieves independent and controllable production, stable quality, and timely delivery. If the standard specifications cannot meet your needs, please contact our sales for consultation. Resi is committed to providing the best precision resistor solutions to meet the needs of customers in automotive electronics, testing and measurement, power equipment, construction machinery, energy storage equipment and other fields.

Electrical Parameters

Series	Resistance	Rated Current	Output Voltage	Max. Operating Current	Operating Temperature	TCR ppm/ $^\circ\text{C}$ (+20 $^\circ\text{C}$ Ref)	Weight (g)	Tolerance (%)
RTCS0500	100 $\mu\Omega$	500A	50mV	600A	-55 $^\circ\text{C}$ ~+170 $^\circ\text{C}$	± 20 (-20 $^\circ\text{C}$ ~+120 $^\circ\text{C}$)	844 \pm 80	± 0.1
RTCS0500	150 $\mu\Omega$	500A	75mV	600A	-55 $^\circ\text{C}$ ~+170 $^\circ\text{C}$	± 20 (-20 $^\circ\text{C}$ ~+120 $^\circ\text{C}$)	844 \pm 80	± 0.1

Part Number Information

Example: RTCS0500B050Z00 (RTCS 500A $\pm 0.1\%$ 50mV Standard)

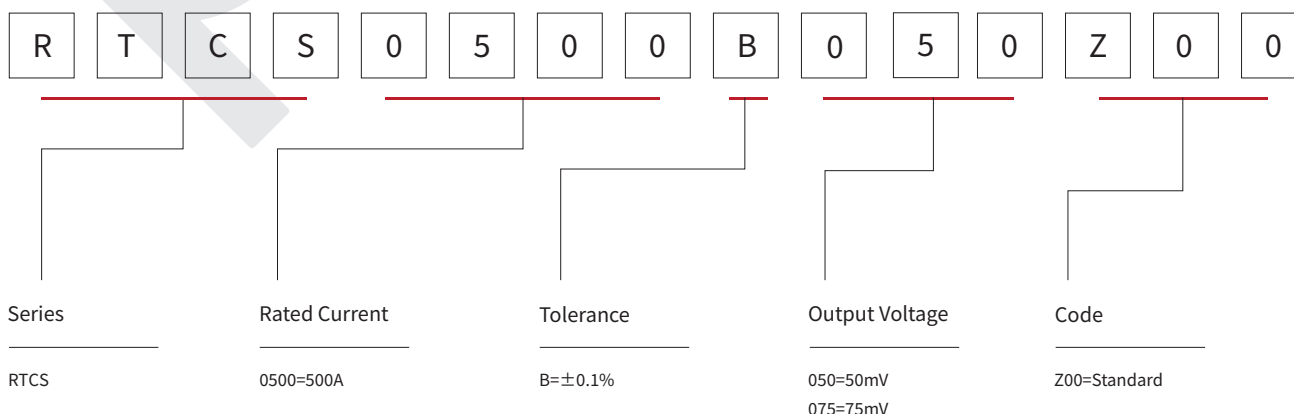

For higher/lower rated current, higher output voltage, please contact us.

Dimensions

Unit:mm

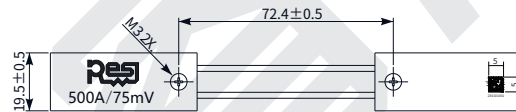
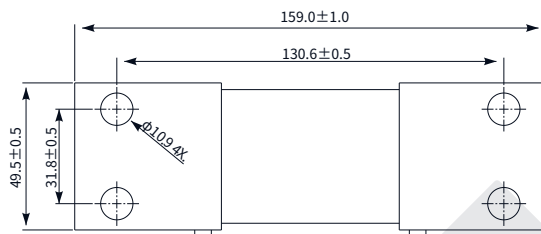
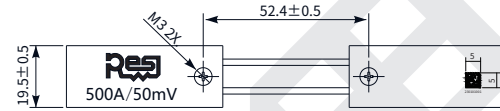
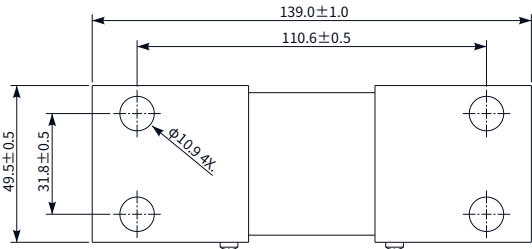

Performance

Test	Test Method	Standards	Test Result
Basic Tolerance	Load 5%, 10%, 20%, 60%, 80%, 120% rated current for 1 minute.	Q/GDW11850-2018	$\Delta R \leq \pm 0.1\%$
Tolerance Consistency	Load 100% rated current. Measure the consistency of the basic tolerance of three parts in the same lot after thermal balance is reached.	Q/GDW11850-2018	$\Delta R \leq \pm 0.05\%$
Tolerance Stability	Load 100% rated current. Measure the resistance after thermal balance is reached. After the shunt cools to room temperature, power on again at 100% rated current to reach thermal balance. Measure the resistance and calculate the rate of change of the two resistance values.	Q/GDW11850-2018	$\Delta R \leq \pm 0.05\%$
Measurement Repeatability	Load 100% rated current. Measure the resistance every 5s after thermal balance is reached. Record 21 times, and calculate repeatability.	Q/GDW11850-2018	$\Delta R \leq \pm 0.02\%$
Thermal Balance Time	Load 100% rated current. Record the tolerance of the shunt per minute. If the change rate every 1 minute of the shunt tolerance does not exceed 1/10 of the rated shunt tolerance, it is considered that the shunt has reached thermal balance.	Q/GDW11850-2018	$\leq 5\text{min}$
Overload Test	2.25 times rated current for 1.5s	Q/GDW11850-2018	$\Delta R \leq \pm 0.1\%$
Temperature Alternating	No load, 60 °C, 6 cycles	Q/GDW11850-2018 GB/T2423.4	$\Delta R \leq \pm 0.1\%$
High Temperature High Current	70 °C for 30 minutes, and load 100% rated current to reach thermal balance.	Q/GDW11850-2018	$\Delta R \leq \pm 0.1\%$
Low Temperature Low Current	-40 °C for 30 minutes, and load 10% rated current for 1 minute.	Q/GDW11850-2018	$\Delta R \leq \pm 0.1\%$

Construction

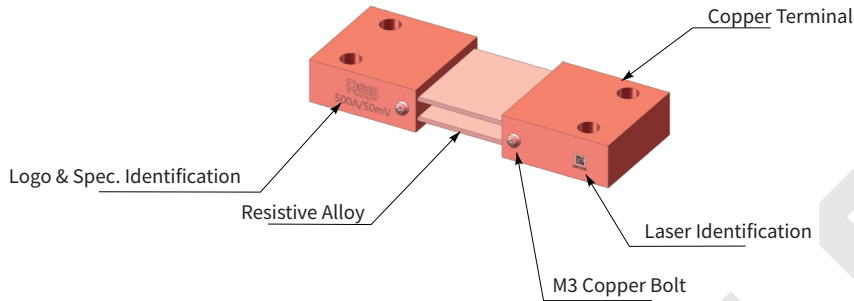

Marking

Marking of product: Logo + product specifications + QR code.

Rated Current

500A

Illustration

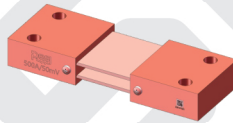

Demonstration

RESI: Brand

500A/50mV: Rated Current/Output Voltage

QR Code: (27 characters in total, including a space)

RTCS0500B050Z00 AL23H13P001

Part Number Traceability Number

Storage Instructions

- (1) The shunt shall be stored at a temperature of 5 to 35°C, humidity<60% RH, and the humidity shall be kept at a low level;
- (2) The shunt shall be protected from direct sunlight;
- (3) The shunt shall be stored in a clean and dry environment, free of harmful gases (hydrogen chloride, sulfuric acid, hydrogen sulfur, etc.);
- (4) Special gloves shall be worn for during installation、storage and handling to reduce the risk of surface oxidation;
- (5) During installation and storage, do not put heavy objects or apply pressure onto the surface of the shunt alloy to avoid product deformation;
- (6) Under the above conditions, the shunt can be stored for at least 1 year.

Installation Illustration

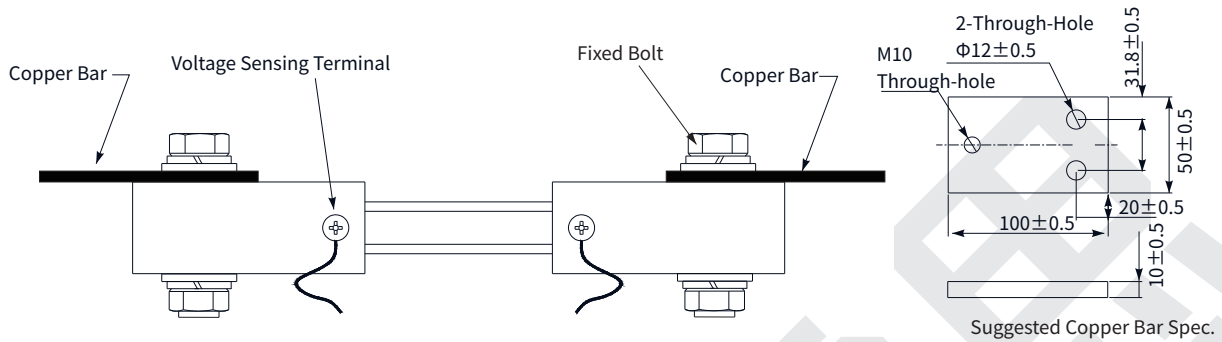

Operation Suggestion

- (1) Please pay attention to the surface protection of the product during use to prevent defects such as scratches, bumps, and oil stains on the surface.
- (2) When installing and using the product, it is important to avoid the influence of mechanical stress on the product.
- (3) According to the IEEE standards, the operating current should not be higher than 2/3 of the rated current under the normal conditions.
- (4) Air cooling, water cooling, increased physical size, and installation of heat sinks can be used to reduce operating temperature.
- (5) The surface of the copper bar used for installing the shunt shall be smooth and clean. It is recommended that the surface be plated with nickel or tin to reduce the contact resistance.
- (6) Suggested installation torque: 0.4~0.8 N·m for M3 bolt and 15~25 N·m for M10 bolt.
- (7) During the installation of the shunt, it shall be ensured that the copper head is in close contact with the bus bar, and the contact area between the copper head and the bus bar shall be as large as possible. If conditions permit, the size of the bus bar shall be as large as possible and the bus bar shall be clean.

Curve of the Resistance of Loaded Shunt

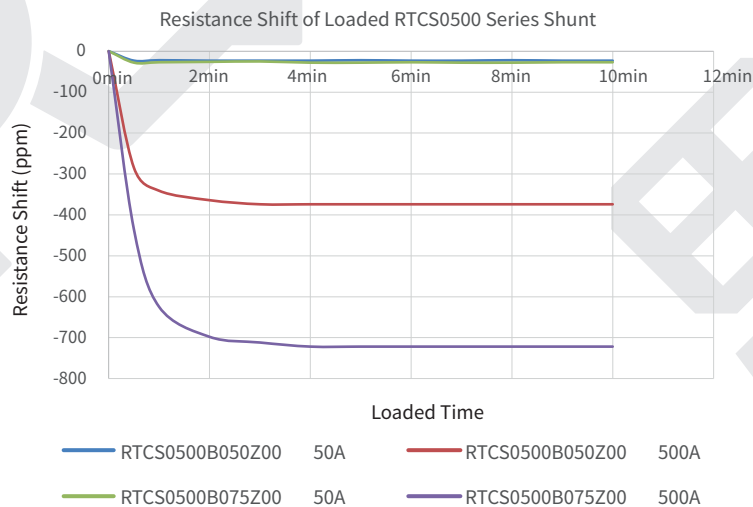

*Under different heat dissipation conditions and different applied copper bar sizes, there will be some differences in the change of shunt on resistance. The above operating conditions are under normal temperature with 100mm² copper wire; For customized test, please contact us to provide detailed operating conditions.

Packaging

- (1) Place 1 shunt into an anti-static bag and vacuum seal it. The size of the anti-static bag is 210mm*100mm;
- (2) Wrap the vacuumed product in a bubble bag and place it in a cardboard box. The size of the cardboard box is about 190mm*70mm*60mm;
- (3) It is advised to fill the gaps inside the cardboard box with bubble bags to ensure that the product is not movable;
- (4) Close the cardboard box and tick the product specifications, then attach the product label.

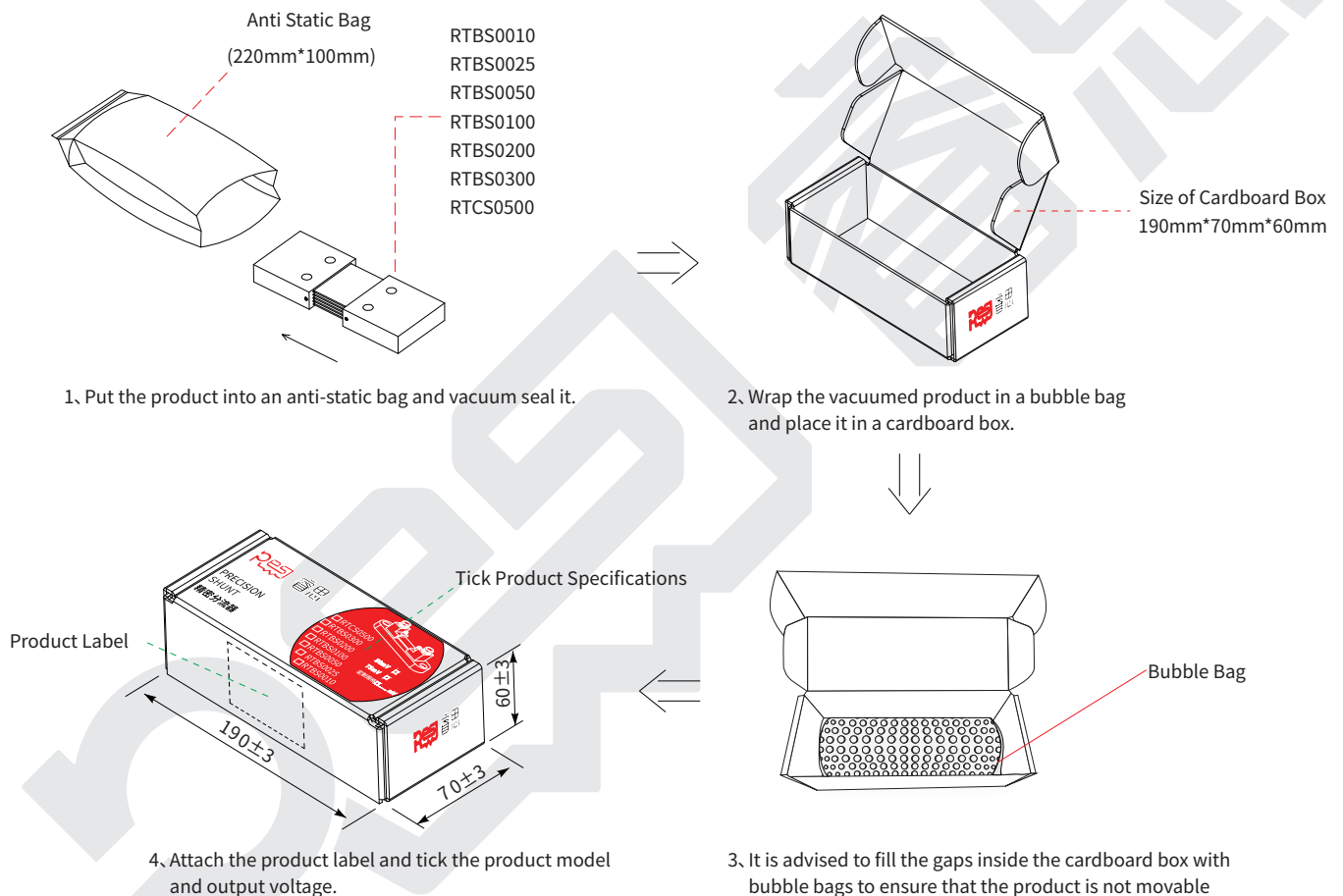

Popular Part Numbers

Part Number	Rated Current	Output Voltage	Tolerance	Resistance	TCR	Max. Operating Current
RTCS0500B050Z00	500A	50mV	±0.1%	100μΩ	±20ppm/°C	600A
RTCS0500B075Z00	500A	75mV	±0.1%	150μΩ	±20ppm/°C	600A

Revision

Version	Revised Content	变更日期	Approver
V0	Initial Issue	2020.03.06	YBP
V1	Add a title and rearrange the layout.	2020.03.25	YBP
V2	Change the physical diagram	2020.04.14	LFY
V3	Product design changes	2021.09.05	LWW
V4	Change datasheet to the new template; Optimize product information	2022.12.26	LWW
V5	Change datasheet to the new template; Optimize product information	2024.03.09	LWW

Disclaimer

All products, datasheets and data can be changed without prior notice.

C&B Electronics Shenzhen CO., LTD., its affiliates, distributors, employees, and any other person acting on its behalf (collectively referred to as "C&B Electronics") shall not bear any legal responsibility for any errors, inaccuracies, or incompleteness of information related to the product disclosed under this agreement or other disclosures.

Product datasheet does not constitute an extension or revision of the purchase terms and conditions in C&B Electronics, including but not limited to the warranties under this agreement.

Unless specified in the purchase terms and conditions, C&B Electronics makes no guarantees, representations or warranties.

To the maximum extent permitted by applicable laws, C&B Electronics hereby makes the following disclaimer:

- (1) All liabilities arising from the use of the product;**
- (2) Including but not limited to all liabilities arising from special, indirect or incidental damages;**
- (3) All implied warranties, including warranties of suitability for special purposes, non infringement possibility, and marketability.**

The information provided in the datasheet and parameter tables may vary in different applications, and the performance of the product may change over time. The recommended application instructions for the product are based on C&B Electronics' understanding and experience of typical requirements. Customers are obligated to verify whether the product is suitable for a specific application based on the parameters provided in the datasheet. Before officially installing or using the product, you should ensure that you have obtained the latest version of relevant information, which can be obtained through the website: resistor.today.

The signing of this agreement does not constitute an express, implied or other form of license related to all intellectual property rights of C&B Electronic Products.

Unless explicitly stated, the products listed in this agreement are not applicable to lifesaving or life sustaining products. In the absence of a clear indication, the customer shall bear all risks caused by unauthorized use of the above products and agree to fully compensate C&B Electronics for all losses caused by such sales or use. For written product terms for such special applications, please contact authorized personnel from C&B Electronics to obtain.

The names and markings on the listed products may be trademarks owned by others.